

ERECTOR

The Toy Like Structural Steel

Here is the Famous Erector Girder

Erector is the *only* construction toy with girders exactly like real structural steel. The patented interlocking edges (an exclusive Erector feature) enable boys to build *big, strong* models of bridges, skyscrapers, inclined railroads, elevators, workshops with machinery of all kinds, battleships, aeroplanes and hundreds of others. The

powerful Erector motor, free with most sets, runs many of the models. It's great fun for boys!



**LOOK
HERE
BOYS**

FREE!

I want to give every boy, absolutely free, a three-months' subscription to my boys' magazine, *Erector Tips*, including the big holiday issue in two colors, brimful of stories and photographs.

Be sure to get this interesting magazine so your boy can read the absorbing story, "How I Invented Erector," and the special articles telling how I became a world's champion athlete. *Tips* also contains full details of the \$2,000 Prize Offer of automobile, motorcycles, bicycles, camping outfits, canoes and other valuable prizes.

Write to-day for the three months' subscription, also a free copy of my new 24-page Book telling all about construction toys. Don't send any money or stamps; *I want to present all this to you absolutely free.*

Erector Sets Sold Everywhere, \$1 to \$25

Be sure to see Set No. 4 for \$5, which contains 571 parts and motor, builds 250 models and is packed in handsome oak cabinet.

**A. C. GILBERT, President
The Mysto Mfg. Co., 136 Fox St.
NEW HAVEN, CONN.**

ERECTOR TIPS
Big Prize Contest
This Auto FREE

Mr. A. C. Gilbert, The Mysto Mfg. Co., 136 Fox St., New Haven, Conn.
Please send me, without a penny of charge, your 24-page illustrated Book and three months' subscription to *Erector Tips*.
Name.....
Address.....
My dealer's name is.....

The Electrical Experimenter

Published by Experimenter Publishing Company, Inc. (H. Gernsback, President; S. Gernsback, Treasurer; M. Hymes, Secretary), 233 Fulton St., New York

Vol. III Whole No. 32

CONTENTS FOR DECEMBER, 1915

No. 8

FRONT COVER—"A CANAL SCENE ON MARS".....	—
From a painting by Thomas N. Wrenn.	
RADIO LEAGUE OF AMERICA.....	381-383
BARON MUNCHHAUSEN'S NEW SCIENTIFIC ADVENTURES.....	
By Hugo Gernsback.	386-388
HOW THE "WIRELESS WIZ" CELEBRATED XMAS.....	
By Thomas W. Benson.	389-390
BUYING BY MAIL. By Thomas Reed.....	391
TO FOIL SUBMARINES WITH UNDERSEA SEARCHLIGHTS.....	392
BY WIRELESS 'PHONE FROM ARLINGTON TO PARIS.....	393
AUDION BULBS AS PRODUCERS OF PURE MUSICAL TONES.....	
By Dr. Lee de Forest.	394-395
THE UNITED STATES ADVISORY BOARD AND ITS PER- SONNEL.....	398-399
THE ELECTRICAL BURGLAR OF THE 20TH CENTURY.....	400
A REMARKABLE ELECTRIC PIANO PLAYER FOR THE "MOVIES." By Frank C. Perkins.....	400
MARVELOUS ELECTRIC SIGN THAT ACTUALLY SPELLS.....	404
HIGH FREQUENCY CURRENTS AND APPARATUS (Concluded). By H. Winfield Secor, E.E.	405

THE RADIO TRANSMITTING SET AT ARLINGTON, VA.....	406
UNITED STATES ARMY FIELD RADIO SET.....	407
LABORATORY EQUIPMENT FOR ILLUSTRATING THE PRINCIPLES OF ELECTRO-MAGNETIC, MAGNETIC AND ELECTRO-DYNAMIC PHENOMENA. By Harlan A. Eveleth.....	414-415
HOW TO MAKE AN ELECTROLYTIC RECTIFIER.....	
By C. R. Barmckol.	416
A PERMANENT MAGNET TYPE VOLTMETER.....	
By Earle Belsinger.	417
"HOW-TO-MAKE-IT" DEPARTMENT.....	419
WRINKLES, RECIPES AND FORMULAS.....	422
"WITH THE AMATEURS" DEPARTMENT.....	424-425
"LATEST PATENTS".....	426
'PHONE PATENTS.....	427
OFFICIAL LIST OF LICENSED RADIO AMATEURS.....	428
OFFICIAL CODE CHARTS GIVING INTERNATIONAL RADIO SIGNALS, CONVENTIONS AND ABBREVIATIONS.....	429
"QUESTION BOX".....	430
"PATENT ADVICE".....	441
BOOK REVIEWS.....	446

Edison and Tesla

IF the recent cabled reports be correct, every American will note with great satisfaction the awarding of this year's Nobel prize in physics to Thomas A. Edison and to Nikola Tesla.

When Alfred Nobel, the multi-millionaire inventor of dynamite and nitroglycerine died in 1896, his will provided for a series of five annual prizes to the most deserving persons in physics, chemistry, medicine, literature and for the best work done in the interest of universal peace.

These prizes have been regularly awarded since 1901, and the learned Academies of Sweden while admittedly well informed and fair as to the award of the prize, have in the past, we believe, overlooked several scientists who by all means were entitled to the prize long ere this.

We are quite convinced, for this reason, that this year's choice of Edison and Tesla will not only be acclaimed in the United States, but in the world over. For, if the world is indebted to two physicists, Edison and Tesla are certainly the biggest single creditors.

The awarding of the Nobel prize in a single year to these two world renowned inventors naturally leads to the question: Who is the greater man, Edison or Tesla? A natural question such as this which surely will arise in the popular mind is manifestly unfair, because the two illustrious scientists have been working in dissimilar fields and their accomplishments are vastly different. Besides, Edison as well as Tesla are hard at work at this minute, and for that reason it is impossible to foretell what they might not still accomplish.

Without wishing to minimize Edison's tremendous amount of work, the fact is well known that he is not so much an original inventor as a genius in perfecting existing inventions.

In this respect Tesla has perhaps been the reverse for he has to his credit a number of brilliant as well as original inventions which, however, have not been sufficiently perfected to permit commercial exploitation.

If the average man were asked what Mr. Edison's greatest gifts to the world are, his choice probably would fall on the Incandescent lamp, the Phonograph and the Cinematograph. Undoubtedly this is a good selection, but it is but a small fraction of the 1,400

inventions which Mr. Edison has patented up to this date. The incandescent lamp would not have been much of an avail to humanity had not Edison perfected at the same time the necessary adjuncts to feed the current to the lamp. He had to make dozens of inventions to accomplish this; the lamp itself was the least of his troubles. Exactly so with the phonograph and the cinematograph several hundred inventions were necessary before either was ready to leave the laboratory. Thus it is a far cry and a weary road from his first tin foil phonograph record to his gold moulded unbreakable Amberol record.

Equally as great as the three above inventions are Edison triumphs in the field of telegraphy, which he revolutionized. His quadruplex telegraph, his telephone transmitter, his alkaline storage battery, his stock printer, his machine for separating magnetic ores, his Portland cement process, his concrete building standardization, are all inventions of the first order.

While Tesla's inventions have not been so numerous as Edison's the world nevertheless owes Tesla a tremendous debt. The modern transmission of power electrically is due entirely to Tesla. Perhaps his greatest invention is the alternating current induction motor, whose wonderful flexibility and vast usefulness have made electrical power what it is to-day. His pioneer work in high frequency currents showed the true genius of the man. This art is as yet but in its infancy and no one can foretell where it will lead us, but it certainly has already opened the way towards the transmission of power without wires. It is not popularly known, but the fact remains that Tesla invented a system of transmitting wireless impulses through the ether in 1893, three years before Marconi began his historical wireless experiments. His wonderful researches on vacuum tubes under the influence of high frequency Tesla currents have practically demonstrated that the day is not far off when the 95 per cent. of electrical energy now wasted in heat in all incandescent lamps will be turned into cold light, that is light without heat. In the long list of brilliant inventions of Tesla, we particularly wish to mention the following: His Sun motor for the utilization of solar energy, his new fluid propulsion turbine, the Tesla high-frequency coil, his rotary transformer, etc. Mr. Tesla's patents now number above 100.

H. GERNSBACK.

THE ELECTRICAL EXPERIMENTER is published on the 15th of each month at 233 Fulton Street, New York. There are 12 numbers per year. The subscription price is \$1.00 a year in U. S. and possessions. Canada and foreign countries, \$1.50 a year. U. S. coin as well as U. S. stamps accepted (no foreign coins or stamps). Single copies, 10 cents each. A sample copy will be sent gratis on request. Checks and money orders should be drawn to order of THE EXPERIMENTER PUBLISHING CO., INC. If you change your address notify us promptly, in order that copies are not miscarried or lost. A green wrapper indicates expiration. All communications and contributions to this journal should be

addressed to: Editor, THE ELECTRICAL EXPERIMENTER, 233 Fulton Street, New York. Unaccepted contributions cannot be returned unless full return postage has been included. ALL accepted contributions are paid for on publication. A special rate is paid for novel experiments; good photographs accompanying them are highly desirable.

THE ELECTRICAL EXPERIMENTER. Monthly. Entered as second-class matter at the New York Post Office, March 1, 1915, under Act of Congress of March 3, 1879. Title registered U. S. Patent Office. Copyright, 1915, by E. P. Co., Inc., New York. The contents of this magazine are copyrighted and must not be reproduced without giving full credit to the publication.



MESCOLITE WILL MAKE YOUR WAY SAFE and BRIGHT

in garage, barn, cellar, closet; in camp; on the motor boat; for the dark country road or any other situation where a lantern, lamp or candle is used, besides many places when an open flame would mean fire, explosion and disaster.

The MESCOLITE consists of a japanned metal container with cover, fibre disc with battery contacts, polished metal reflector, clear glass lens, miniature battery lamp, lens cap or rim with three bayonet catches, a non-detachable bail or handle large enough to allow the arm to go through it, and a RED SEAL Dry Battery. The light is strong, bright and steady and absolutely unaffected by weather conditions. For efficiency, economy and serviceability it is unsurpassed by any other battery lantern. Another good feature is that the battery cannot be inserted in the container in any other way than the RIGHT WAY.

The Red Seal Battery will give about twenty-five hours of continuous service and from forty to fifty hours of intermittent service. Always use the RED SEAL Dry Battery in preference to any other. It does not deteriorate when not in use. If the RED SEAL Dry Battery cannot be had any other standard size dry cell can be used.

The MESCOLITE can also be supplied with a "Special" two cell dry battery which will give approximately 60 hours of continuous and 120 hours of intermittent service.

(Illustration shows container with cover off and battery partly inserted)

No. 5343—MESCOLITE, complete with RED SEAL Dry Battery 1½-volt lamp.....\$1.50

No. 5344—MESCOLITE, complete with "Special" two cell dry battery.....\$1.75

Send for Our Manual No. 9 on Wireless Telegraphy



You should have it even if only superficially interested. Around about you every day you read of some marvelous occurrence in which wireless played a distinguished part. It may not be entirely clear to you. The Manual will explain it. To the student of Wireless Telegraphy the Manual contains much that is indispensable to a proper understanding of the art. A good portion of this is now published for the first time— and consists of formulas, tables, diagrams, Federal regulations, codes, diagrammatic instruction for installing, maintaining and operating wireless stations, together with a complete list of up-to-date wireless instruments and accessories.

The Manual contains 120 pages, fully illustrated on high-grade paper stock with a two-color cover.

We ask ten cents (\$0.10) for it—give you a coupon receipt which can be applied on any order amounting to One Dollar (\$1.00) or more.

Do not wait until some other time, but sit down now and send your name and address, and get one of the most complete, comprehensive and reliable wireless pamphlets published.

Send for Our New Catalog W 28

It is pocket size, 8x4½ inches, contains 248 pages, with over 1,100 illustrations, and describes in plain, clear language all about Bells, Push Buttons, Batteries, Telephone and Telegraph Material, Electric Toys, Burglar and Fire Alarm Contrivances, Electric Call Bells, Electric Alarm Clocks, Medical Batteries, Motor Boat Horns, Electrically Heated Apparatus, Battery Connectors, Switches, Battery Gauges, Wireless Telegraph Instruments, Ignition Supplies, etc.

There exist a thousand and one ways where electrical devices may be used, and to know what is best for your purpose you need this catalog.

IT MEANS MONEY SAVED TO YOU to have our Manual and our Catalog when you want to buy.



MANHATTAN ELECTRICAL SUPPLY CO.
 NEW YORK CHICAGO ST. LOUIS SAN FRANCISCO
 17 Park Place 114 S. 5th Ave. 1106 Pine St. 604 Mission St.

Christmas Joy

and permanent satisfaction are assured to those who select their purchases from our new catalog. Every reader will find something electrical to please, to mystify or to entertain.

- The best the world affords in
- Motors
- Dynamos
- Lighting Plants
- Meters
- Spark Coils
- Electrical Toys
- Heating Devices



- Cooking Devices
- Parts and Supplies
- Switches
- Motion Picture Machines
- Phonographs
- Wireless Telegraph Apparatus
- A profusion of other things electrical.

Our catalog is a joy to the experimenter; a necessity to everyone, and is boiled down to 112 pages, 100 per cent. interesting. *It's free.*

CLAPP-EASTHAM CO. MANUFACTURERS AND DISTRIBUTORS
 141 MAIN STREET : : : : CAMBRIDGE, MASS.



THE ELECTRICAL EXPERIMENTER

H. GERNSBACK EDITOR
H. W. SECOR ASSOCIATE EDITOR

Vol. III. Whole No. 32

DECEMBER, 1915

Number 8

The Radio League of America



HONORARY MEMBERS

Captain W. H. G. Bullard, U. S. N. Prof. Reginald A. Fessenden.
Nikola Tesla. Dr. Lee de Forest.

Manager, H. Gernsback

A Retrospect.

DURING the past year the need of a national body to champion the cause of the wireless amateurs in the United States has become more and more pressing. There are now over 300,000 radio amateurs and about 350 local clubs in existence in the United States, but there is no national body to safeguard the interests of the amateurs.

When H. Gernsback, in 1909, organized the *Wireless Association of America*, there did not exist at that time a wireless club in the United States. There were then, of course, numerous radio amateurs in this country, but the wireless art—as far as the amateur was concerned—was only in its earliest infancy. Mr. Gernsback, who at that time sensed approaching danger to the wireless amateurs in the form of hostile legislation, succeeded in banding together the majority of wireless enthusiasts, and the membership of the association grew rapidly till at the end of 1912 there had been enrolled no less than 22,300 members.

In those early days the wireless amateurs in this country were a rather reckless sort of element and became more and more disliked on account of their growing mischief. False distress and alarm calls by perverted "humorists" were the usual "smart" acts, and when a coastal station received a C.Q.D. call in those days the thought was always uppermost in the operator's mind that the call was one of the usual amateur hoaxes. Despite Mr. Gernsback's vigorous warnings through his editorials in *Modern Electrics*, of which publication he was editor, the mischief continued, till in 1910 several bills were introduced in Washington which fairly promised to throttle the

activities of every wireless enthusiast in the country.

This, of course, brought the amateurs to their senses speedily, but had it not been for the formation of the *Wireless Association*

thermore succeeded in enlisting the press of the country in taking up the cry to save the amateurs from hostile legislation. All this had the desired effect, and when finally in 1913 the Alexander Wireless bill, amended, was signed by President Taft, thereby becoming law, it contained almost word for word Mr. Gernsback's historical recommendation of his editorial in the February, 1912, issue of *Modern Electrics*. As is well known, that editorial called the attention to the lawmakers that in case the amateurs were to be restricted the latter should be allowed to operate their stations at a wave length below 200 meters, and they should furthermore be allowed the use of power up to one kilowatt. This suggestion saved the day, and the amateur at last had come into his own.

With the passing of the wireless act in 1913 the usefulness of the *Wireless Association of America* had come to an end, and thus matters rested.

A Formidable Defense Weapon.

THE advent of the great European war in 1914 found the United States in an unprepared condition as regards its defenses and vigorous steps were promptly taken to wake us up from our lethargy. President Wilson's recommendation to the country for a vast increase of our army and navy has been so much discussed of late that no further reference to his valuable ad-

vice is required here. It suffices to say that probably a vast majority of citizens indorse the President's defensive military program.

But there exists to-day a formidable defense weapon, which up to now has not been exploited by Uncle Sam. We refer

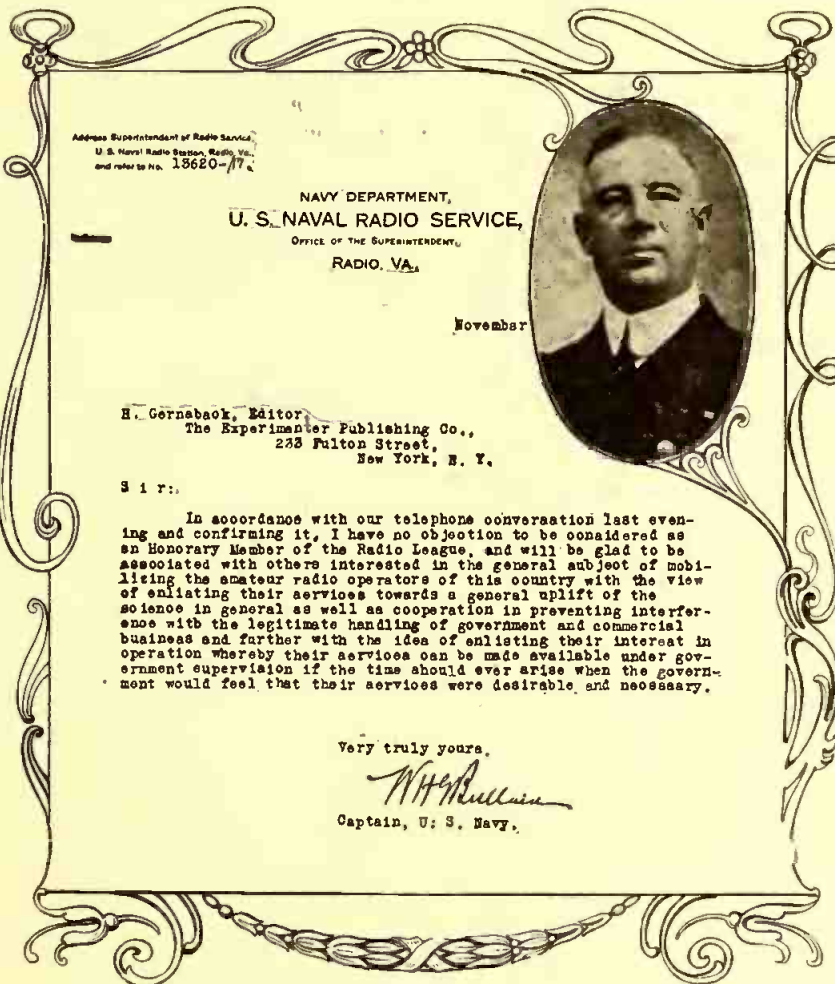

Captain Bullard's Letter of Acceptance as Honorary Member in the Radio League of America.

tion of *America* a year earlier, all efforts would have been in vain and the amateur would to-day be as dead an issue as he is at present in Europe. Through the Association Mr. Gernsback caused thousands of letters to be written to Washington officials by the wireless amateurs, and he fur-

CERTIFICATE OF INCORPORATION OF THE RADIO LEAGUE OF AMERICA, INC.

State of New York City of New York County of New York } ss.:

We, The Undersigned, of full age, citizens of the United States, a majority of whom are citizens of the State of New York and resident therein, being desirous of associating ourselves together for our mutual welfare and advancement, as hereinafter is more particularly described, pursuant to and in conformity with Chapter Forty (40) of the Laws of 1909 and known as the Membership Corporations Law, do hereby certify and declare as follows:

First—That the name by which the said corporation hereby to be formed shall be known and distinguished is and shall be Radio League of America, Inc.

Second—That the purposes for which the corporation is to be formed are as follows:

To promote the art of amateur wireless telegraphy and telephony in the United States among the members of the said corporation; to have available for the Government of the United States or any of its officials a complete list of all the amateur radio stations in the country pledged to the service of the Government for use in times of national danger or need; to establish a uniformity in the transmission of wireless messages by amateurs; to uphold the provisions of a law known as the Wireless Act of 1912 and all subsequent laws pertaining to wireless telegraphy; to assist the Government of the United States or any of its officials in apprehending offenders thereof; to prevent the sending of misleading wireless messages; to give information to the members of the said corporation concerning new and useful devices in the operation of wireless telegraphy and telephony and to provide an organization for the interchange of ideas concerning wireless telegraphy and telephony for the benefit of the members and the public at large.

Third—That the number of directors of the said corporation shall be and are five (5) in number; and that the names and residences of such directors who shall manage its concerns until the first annual meeting are as follows: (See below.)

Fourth—That the territory in which the operations of the corporation are to be principally conducted is the entire United States, and that its principal office shall be and is located in the Borough of Manhattan, City, County and State of New York.

Fifth—That the said corporation shall hold its annual meetings on the first Monday in October in each and every year beginning with the year 1916 (October 2, 1916), and annually thereafter.

In Witness Whereof we have made and signed this certificate in duplicate and have hereunto set our hands and seals this 25th day of October, 1915.

Hugo Gernsback, Sidney Gernsback, Milton Hymes, Harry W. Secor, Frederick H. Pruden.

As will be seen, the League is a purely scientific organization. There are no dues, no membership fees to be paid. It has been organized under the auspices of the world's greatest wireless men, who thoroughly endorse its principles. It is not a money making organization, nor is it conducted by a commercial wireless company for its benefit.

The Electrical Experimenter has been selected as the league's official organ, as this journal, with the largest circulation of any wireless publication at present, reaches either directly or indirectly almost every wireless amateur in the country to-day. It

will publish the league's news from month to month, thereby keeping up the interest of its members.



The League's Rules.

VERY wireless amateur of good standing, whether he has a sending or a receiving station, is eligible for membership. There are but two conditions:

- 1. He must be a citizen of the United States.
2. He must own either a sending or receiving station, or both.

Each member will be supplied with an official membership certificate furnished free by the Radio League of America. Our illustration gives a good idea of this beautiful certificate, but it must be seen to be fully appreciated. It is lithographed on a heavy bond paper in green and gold, and its size is 15x11 1/4 inches. The text follows:

CERTIFICATE OF MEMBERSHIP TO THE RADIO LEAGUE OF AMERICA.

A membership organization organized under laws of State of New York.

I, the undersigned, a radio amateur, do hereby apply for membership in the Radio League of America, upon the express condition that by so doing I do not assume or incur any liability either for dues, assessments or any financial obligations whatsoever, and, if accepted, I do agree to follow and abide by the rules and regulations of the league as set forth herein, and all other rules and regulations which may hereafter be adopted.

Rule 1. To observe all rules and regulations of the Wireless Act of 1912 (as set forth on the back of this certificate).

Rule 2. That I will at all times have my station in readiness and at the service of the United States Government for use in any defensive or offensive purpose in periods of war, riot or disaster.

Rule 3. That I will at all times allow my station and equipment to be used by the United States Government or any of its officials, and will assist, if possible, in apprehending offenders violating the Wireless Act.

Rule 4. I furthermore solemnly and distinctly pledge myself not to send out at any time whatsoever, a misleading call, particularly a distress call (S. O. S.) nor knowingly allow another to use my station for sending out such a call.

Rule 5. That I will at all times, in case of necessity transmit a distress call to the nearest official, either by wireless, by wire,

or in person, and that I will do everything in my power to bring assistance to the party or parties thus in danger.

Rule 6. That I will communicate to the League such information concerning the operation and construction of my radio station as will be helpful or instructive to the other members of the League.

Rule 7. That I will, when requested, furnish information concerning my radio station and observations, which information is to be used by the League in its compilation of wireless statistics.

Rule 8. That I will carefully read and adopt any suggestions published by the League for the benefit of its members, and the transmission of wireless communications.

Rule 9. That in case of my removal to another address, or in case of the permanent discontinuance of my station, I will immediately communicate such facts to the manager of the Radio League of America.

Rule 10. That I will display my membership certificate in the League in a conspicuous place in my radio station.

In witness whereof I have signed my name and address, etc.

Each certificate is numbered and a member is entitled to one membership certificate only. Before the League can furnish a certificate it is necessary that the prospective member shall fill out an application for membership; a convenient blank being printed below. (If it is not desirable to cut up the magazine, a blank will be promptly mailed on receipt of a 2c. stamp to cover necessary mail charges.)

No blank is valid nor can it be accepted unless it is filled out properly as prescribed. Two persons must sign as witnesses to the signature and these may be two friends, or your father and your mother, or a sister and a brother, etc.

Upon receipt of the application blank the official membership certificate will be mailed. Ten cents in stamps or in coin should be inclosed to cover mail charges, handling, as well as the heavy cardboard tube to insure safe delivery.

Upon receipt of the membership certificate by the member it must be signed at once in ink in its proper place, and it should then be suitably framed and hung up in the station in a conspicuous place.

It will give your station official recognition, and within the next few months the amateur who cannot produce an official membership certificate will hardly be looked upon on a par with officially recognized amateurs. He will have but little standing

Application for Membership in the Radio League of America

I, THE UNDERSIGNED, a Radio Amateur, am the owner of a Wireless Station described in full on the back of this application. My station has been in use since and I herewith desire to apply for membership in the RADIO LEAGUE OF AMERICA. I have read all the rules of the LEAGUE, and I hereby give my word of honor to abide by all the rules, and I particularly pledge my station to the United States Government in the event of war, if such occasion should arise.

I understand that this blank with my signature will be sent to the United States Government officials at Washington, who will make a record of my station.

Witnesses to signature: Name City State Date 191

Describe the apparatus of your station on the back of this application.

In the event of national peril, you will volunteer your services as a radio operator in the interest of the U. S. Government?

This last question need not be answered unless you so desire it.

NAVY DEPARTMENT, U. S. NAVAL RADIO SERVICE.

OFFICE OF THE SUPERINTENDENT.

RADIO, VA..

H. Gernsback, Editor, Sir:

I beg leave to acknowledge the receipt of your letter of November 8, 1915, submitting information concerning the Radio League of America, together with a copy of the Certificate of Membership.

It seems to me that you have undertaken to carry through a very patriotic motive in banding together the great number of amateur wireless operators in the United States, which, as you state, now number probably over 100,000, of which only about 3,000 have been licensed; it being presumed that the remainder operate receiving stations only, and under the law are not required to have licenses. This latter proposition I regard as a very serious detriment to the proper government control of wireless stations, and am of the belief that legislation should provide that all stations, whether for transmitting or receiving, should be licensed by the Federal Government. Although the Radio Act provides penalties for divulging any information received by means of wireless receiving circuits, yet the fact that important govern-

ment messages might be received by unscrupulous amateurs not friendly to the home government renders some form of protection necessary, and, I might add, will be advocated this coming Congress.

The Naval Radio Service is particularly anxious to increase its operating personnel in time of public peril when many private stations, ship and shore, would probably be taken over by the general government, and the thought has arisen that through co-operation with the Radio League many of its members would like to enroll themselves for active service under the Navy Department at such times as their services might be required.

You can readily understand that any information collected by the Radio League will be of the greatest value to this service and this office will be glad to avail itself of your kind offer to furnish such free of all cost, this to contain the names, locations, etc., of all amateurs in the United States.

I should like further to take advantage of this opportunity to ask your co-operation in enrolling members of the Radio League for government (Navy Department) operation in time of war, and take this opportunity to enclose a circular prepared in this office which we have sent out to operating wireless companies in the United States, who in turn have distributed

them to their operators, with the result that many civilian operators have engaged themselves to enlist in the Navy in time of war. Could we not do something similar to enlist members of your League, and would you lend your efforts to co-operate along these lines by giving the matter a little publicity? From the monthly list you propose to furnish we can get the names and addresses of many amateurs, among whom we might find many who would wish to enroll themselves. Of course, the forwarding letter accompanying the circular would have to be modified, but that could easily be done to call the attention of amateurs to how they can really serve their country in time of need.

Please accept my thanks for thus being allowed to bring to your attention certain views in connection with the Radio League, an organization which can be made to be of the utmost help to the government, and by focusing the attention on existing laws bring home to every amateur the desirability of co-operation all along the line to correct the great question of interference with proper government, commercial and other legitimate correspondence handled by means of the wireless art.

Very truly yours, (Signed) W.H.G. Bullard, Captain U. S. Navy, Supt. Radio Service.

as a wireless amateur, for he obviously refused to pledge his station to his Government.

relationship between you and these members depends entirely upon yourself. Thus the



The League's Official Button.

League will be highly instrumental in bringing together members and cementing their friendship.

Associations and Clubs: LOCAL wireless association, or radio club, to be officially recognized by the League must have at least six members. There should be a president, a treasurer and a secretary. The address where such a body meets should be stated. Clubs and associations should meet at least once a month. The above requirements are necessary to secure publication in the Electrical Experimenter, as well as recognition in the "Radio League of America's Official Year Book."



In this book, to be issued once a year, will be found all the important League news, a full listing of all the clubs and associations, as well as a complete list of all the members.

The League particularly indorses and encourages the rendering of scientific lectures by their members. The latter should write scientific papers, particularly those that have a wireless subject as its theme. The president of the club should select the best paper in his opinion, and it should be sent then to the editors of the Electrical Experimenter. If it has sufficient merit it will be published in due course in the Electrical Experimenter. It will show the title of the author as well as a sub-title, giving the name of the club to which the author belongs.

Once a year the best paper from among those that were published in the Electrical Experimenter will be selected by the editors and this prize paper will be published in the official year book. This honor will only be accorded to one paper.

Official League Insignia.



An official button securable only by the League's members is illustrated herewith. This distinctive, as well as striking, design measures 3/4 inch in diameter. It is inlaid in real, hard enamel in the three national colors, red, white and blue. The aerial design as well as the mast is in gold on a dark blue background. The button is heavily gold filled and is guaranteed by the makers not to tarnish for two years. It will positively not turn brassy. You will be proud to wear one of these distinctive buttons.

The League furnishes the button at cost; the price, including mailing, being 20c. Both the membership certificate and the button will be sent for 25c. prepaid.

A solid gold button as described above is furnished for \$3 prepaid to those not desiring a gold filled one. The solid gold button and the membership certificate will be furnished for \$2.05 prepaid, the actual cost of both.

All communications should be addressed to

THE RADIO LEAGUE OF AMERICA, 233 Fulton Street, New York City.

Description of My Station and Apparatus

Sending

Receiving

(OVER)

CERTIFICATE OF MEMBERSHIP

TO THE RADIO LEAGUE OF AMERICA A MEMBERSHIP CORPORATION ORGANIZED UNDER LAWS OF STATE OF NEW YORK



Honorary Members

Dr. Lee De Forest Nikola Tesla
Dr. Reginald Fessenden Capt. W. H. G. Bullard

I, the undersigned, a radio amateur, do hereby apply for membership of the RADIO LEAGUE OF AMERICA, upon the express condition that by so doing I do not assume or incur any liability either for dues, assessments or any financial obligations whatsoever, and if accepted, I do agree to follow and abide by the rules and regulations of the LEAGUE as set forth herein, and all other rules and regulations which may hereafter be adopted.

- Rule 1. To observe all rules and regulations of the Wireless Act of 1912 (everything in my power to bring assistance to the party or parties thus in danger).
- Rule 2. That I will at all times have my station in readiness and at the service of the United States Government for use in any defensive or offensive purpose in periods of war, riot or disaster.
- Rule 3. That I will at all times allow my station and equipment to be used by the United States Government or any of its officials, and will assist, if possible, in apprehending offenders violating the Wireless Act.
- Rule 4. I furthermore solemnly pledge myself not to send out at any time whatsoever, a circulating call, particularly a distress call (S. O. S.) nor knowingly allow another to use my station or sending out such call.
- Rule 5. That I will at all times, in case of necessity assist a distress call to the nearest official, either by wireless, by wire, in person, and that I will do so.
- Rule 6. That I will communicate to the I.F.W.C.E. such information concerning the operation and construction of my radio station as will be helpful or instructive to the other members of the I.F.W.C.E.
- Rule 7. That I will, when requested, furnish information concerning my radio station and operations, which information is to be used by the I.F.W.C.E. in its compilation of wireless statistics.
- Rule 8. That I will carefully read and adopt any resolutions published by the I.F.W.C.E. for the benefit of its members, and the transmission of wireless communications.
- Rule 9. That in case of my removal to another address, or in case of the permanent discontinuance of my station, I will immediately communicate such facts to the Manager of the RADIO LEAGUE OF AMERICA.
- Rule 10. That I will dispense my membership certificate in the I.F.W.C.E. in a conspicuous place in my radio station.

In witness whereof I have signed my name and address this _____ day of Nov. 1915

Name John Peter Doe
Address 1915 ... St. S.

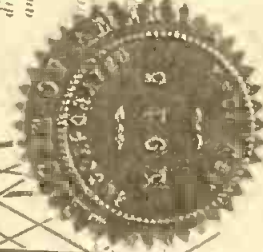

Manager Radio League of America

1603

The Handsome Membership Certificate of the Radio League of America Engraved in Green and Gold. The size is 15"x11 1/4". Every member is assigned a number.

Baron Münchhausen's New Scientific Adventures

By Hugo Gernsback

Münchhausen is Taught "Martian"

PUNCTUALLY, as always, at exactly 11 P. M. the next evening, Münchhausen's dear old voice once more sounded in my receivers. There was the usual preliminary talk, after which the Baron went on:

"I am very much pleased, my dear Alier, that my Radiotomatic relay station on the Moon works so well. Up to last night neither Flitternix nor myself were sure if we could bridge the 60 million miles between Mars and the Moon by wireless, but by means of our wonderful ultra sensitive radio-active detector we were enabled to 'listen in' successfully. When I had finished talking last night, it was about 9 P. M., your terrestrial time. We got our receiving instruments ready at once and promptly at 11 P. M. I could hear myself talk-

ing. The message which I had sent a few hours before had been faithfully recorded on the telegraphone wire of my Radiotomatic on the Moon, and as soon as the automatic clock released the sending machinery, the vibrations carrying my voice were hurled back to us over a distance of 60 million miles. From this we knew that you must have heard the message too, for you are but 238 000 miles distant from the Moon. While my 'canned' voice undoubtedly must have sounded uncanny to you—excuse the pun—I assure you that it gave me the creeps listening to my own voice, flung 60 million miles through the ether!

"But to come back where I broke off last night: I told you how several Martians had approached us and had placed a soft metallic cap on our heads. I also told you how we then followed the august Martian into the church-like structure.

"While we walked over the hard metallic-appearing walk, which conducted us to the structure, we became conscious of strange flashes in our brains. We also caught distinct, though faint, bars of a soft music, which was followed by weird pictures flashing through our minds. All this took place within our heads, and as I closed my eyes for a few seconds to test myself, the music as well as the picture flashes persisted; I knew then that I did not hear the music with my ears, nor see the pictures with my eyes. I reasoned correctly that both had their origin within my brain.

"Before I had time to puzzle it out, we had entered the structure at the heels of our host. We passed through a magnificent archway, constructed entirely of some transparent material, decorated in superb taste in green, white and gold. One thing struck us immediately; the hallway appeared as light as day, but we could not see where the light originated. Later, though, we were to find out about this.

"As the end of the hallway was a ponderous massive panel with a door-like appearance. It must have been at least 125 feet high and 30 feet wide. It looked very much like cut glass with all its prisms and fancy cuts; we first thought it was glass, but when we came closer to it we changed our minds, for we saw that the

huge thing was as flexible as a velvet portière. When our host was but 10 feet away from it, it suddenly blazed forth in a brilliant golden light which seemed to

is about 60 feet high, with an immense golden transparent cupola forming the ceiling. The tables, the chairs, all the furniture, as well as all the objects for which we had no names, seemed transparent. Even the walls seemed transparent, as well as the soft, rug-like carpets

on which we walked. But the wonder was centered not solely in the transparency of the strange material, but in the fact that it gave forth a soft, white light. Imagine a solid chair of glass, glowing in a mellow, white light—not a brilliant light—and you have a good idea what we beheld. It struck us at once that this wonderful material could be handled at will by the Martians; for, the luminous rugs on which we stood were soft as velvet, while a desk-like object nearby seemed hard as

ONE of the greatest puzzles our astronomers and scientists had to contend with during the last decade is the problem of how water is moved in the Martian "Canals." Nearly all scientists of note who have studied them do not question their existence, but they are all at odds as to what agency moves such enormous quantities of water. It is singular that most of them suggest a form of pump to move the water in the canals, as our present-day knowledge of science and mechanics leaves them no other choice.

But what makes our rivers flow on Earth? What agency condenses billions of tons of ocean water and brings these waters down in form of rains, which keep our rivers from drying up? The Sun, of course. Why can't the Sun move the waters in the Martian Canals also? This installment contains a new idea, how the Martians might accomplish it.

come from nowhere. Simultaneously the huge door, for this is what it was, rose quickly up in the air just like a theater curtain. Our host now entered into a large circular salon-like room, followed reluctantly by us.

"I say reluctant advisedly. I have absolutely no adjectives to do the thing justice. Our state of mind upon entering that room was probably the same as if you had brought back to life Julius Caesar of the year 50 B. C., and had suddenly transplanted him some night on blazing Broadway in New York. His mind would have reeled at the—to him—marvelous sights. It would have taken him days and days of asking questions and explanations of all the impossible things he saw before him.

"Exactly so with us. Only Caesar would have made a jump of but 1,965 years, where we made one of over 200,000 years. We were but uncomprehending children, and our eyes and senses were absolutely inadequate to do justice at once to the higher plane of civilization on which we had been thrown so suddenly. We have been on Mars eight days now and still we know practically nothing of this most miraculous world. Every day brings more tremendous surprises and at night we are usually exhausted from all the excitement of the continuous bombardment of new and wondrous things on our brains.

"But to come back to the wondrous salon of our host, who, as we found out later, was the reigning Ruler of the Planet Mars. The house in which we were was a sort of executive mansion or palace, and the room in which we were standing was what you might call the Ruler's office.

"Here I must stop again to advise you that it is extremely difficult for me to explain in existing terrestrial terms what we see, hear and feel, for everything on Mars is so totally different from what we are accustomed to on Earth, that my best comparisons with terrestrial things must of necessity fall far short of actual conditions on Mars. However, I will do my best to convey a true picture to you.

"The thing that struck us with greatest force at first was that everything in this immense room appeared transparent. The room, which is about 150 feet in diameter,

steel. The next thing which attracted most of our attention were the luminous walls. They were all paneled in a curious manner, and, of course transparent and luminous. Each panel had a vast amount of small hexagonal plate-like facets arranged somewhat in honeycomb fashion. These hexagonal cells were constantly changing in soft colors, and the most unique, as well as pleasing, geometrical designs in colors were thus unendingly produced. It was a fascinating sight, and we found it hard to take our eyes from these walls.

"At the far end of the room we noticed four Martians whom we recognized at once as females on account of their mass of hair and their more delicate features. Their heads seemed somewhat smaller than those of the males, but they appeared to dress exactly like the men, except that the color of their metallic looking dresses was of a much lighter shade. But it was not the 'girls' that drew our attention as much as what they were doing. We could not rid ourselves of the idea that these females were some sort of secretaries to our host, and it was manifest that they were 'working' at something. And they appeared to be working earnestly and diligently, too, but there were no pencils, no books, no paper, no typewriters; in fact, nothing whatsoever that a terrestrial secretary requires to get up her superior's reports.

"Instead each girl sat motionless in front of a small glass-like table which was entirely bare and flat, except for the center, from which projected two small glass-like rods each about 4 inches high and as thick as a pencil. At the top they bent over and formed a gooseneck pointing in the direction of the girls. The rods were both pointed at their ends, and while one appeared luminous, the other seemed dark.

"The 'operators' were watching the point of the luminous rod intently, and the expression of their faces was as if they were reading something. Every once in a while they seemed to relax and at that moment a curious white ray seemed to pass from the light point of the rod into the point of the dark one. That was all we could see.

"While we were still wondering our host motioned us to sit down on the comfort-

able looking arm chairs. These chairs, as already mentioned, appeared like transparent glass, but when we put our hands on them they felt like satin and not at all hard or cold. The transparent seats, which had a moment before appeared as glass, were soft and flexible as an air-cushion and extremely comfortable. The only trouble with the chairs was that they were too big for us. Built for large 8-foot Martians, our feet hardly reached the floor, so we sat in the chairs just as children sit in big armchairs, that is with our backs resting against the inside back of the chair and our legs and feet projecting straight out on the seat; and only then were we quite comfortable.

"This position, ridiculous as it doubtless was, evoked a faint smile from our host, who sat down in his own chair in front of a large piece of furniture that was a cross between a rectangular table and a flat top desk, garnished in its center with a huge birthday-cake-like affair with 10 transparent and 10 dark glass-like candles, curved in gooseneck form.

"Our host then turned around to us and looked us over long and earnestly. His large, liquid blue eyes were wonderful in their depth; in them shone a wisdom as, indeed, we had never before beheld. His face had a very benevolent expression, and the features were clear and sharply defined. He appeared tremendously intellectual, yet will power and strength of character radiated from his face in an amazing manner. We thought at last that he was going to speak to us, instead he

as if I had tried to think intently of the terrestrial globe, as it stands silhouetted against a dark sky. Then in quick succession followed our 'Interstellar,' the Planet Mars, a picture of our capture by the Martians with their yellow rays and their floating fortresses, then an exact picture of how we appeared at our landing on Mars.

"It then dawned on us that our host was 'talking' to us, not in words and not in a strange language, but motion-picture-wise. *We had experienced the first transference of thoughts*, and had understood everything our host had 'said,' because he thought in pictures which were perfectly familiar to us, not in words which would have had no meaning for us! When there was a lull we opened our eyes in astonishment and blinked bewildered into the smiling eyes of our august host. He seemed highly amused at our amazement and once more he motioned to us to close our eyes.

"For the next hour or more we had our first lesson in 'Martian.' In easy stages our host first flashed simple pictures into our minds, which were then followed by scenes with various actions and explanations just as in a moving picture scene, where the mind must infer what the actors are saying to each other by the expression of their faces and their obvious actions.

"There was a short pause, after which our host launched into the 'Evolution of Mars.' We were first shown how the planet, millions of years ago, was but a

and stones, then we saw for a long period the slow evolution of Mars down through the ages till a civilization similar to that of present terrestrial conditions was reached. There were the wars, the barbarism and the thousand other evils exactly as those experienced by man on Earth. Evolution, after all, is the same throughout the Universe, given like conditions.

"As the story of the evolution went on we could see how the Martian's small head and his small chest both kept on increasing with each subsequent generation. We were shown how big oceans and inland seas, as well as vast rivers, dried up gradually, and how the whole population turned into mechanics, electricians and chemists. No true happiness and contentment, however, seemed to exist on Mars until thought transference was established, till gravity was conquered and money was abolished. There had been wars and disorders up to that period, but it seems that these three things, apparently invented and originated at about the same time, finally emancipated the race completely. As we found out later, this period was reached some 14,600 years ago.

"Beginning with that period only did the Martians really become great. We saw how in less than five generations speech had been entirely abolished, it being possible to 'converse' over considerable distances by thought transference. We were shown the evils of too many languages and the race hatreds produced thereby, and how finally one universal language was adopted by all races and

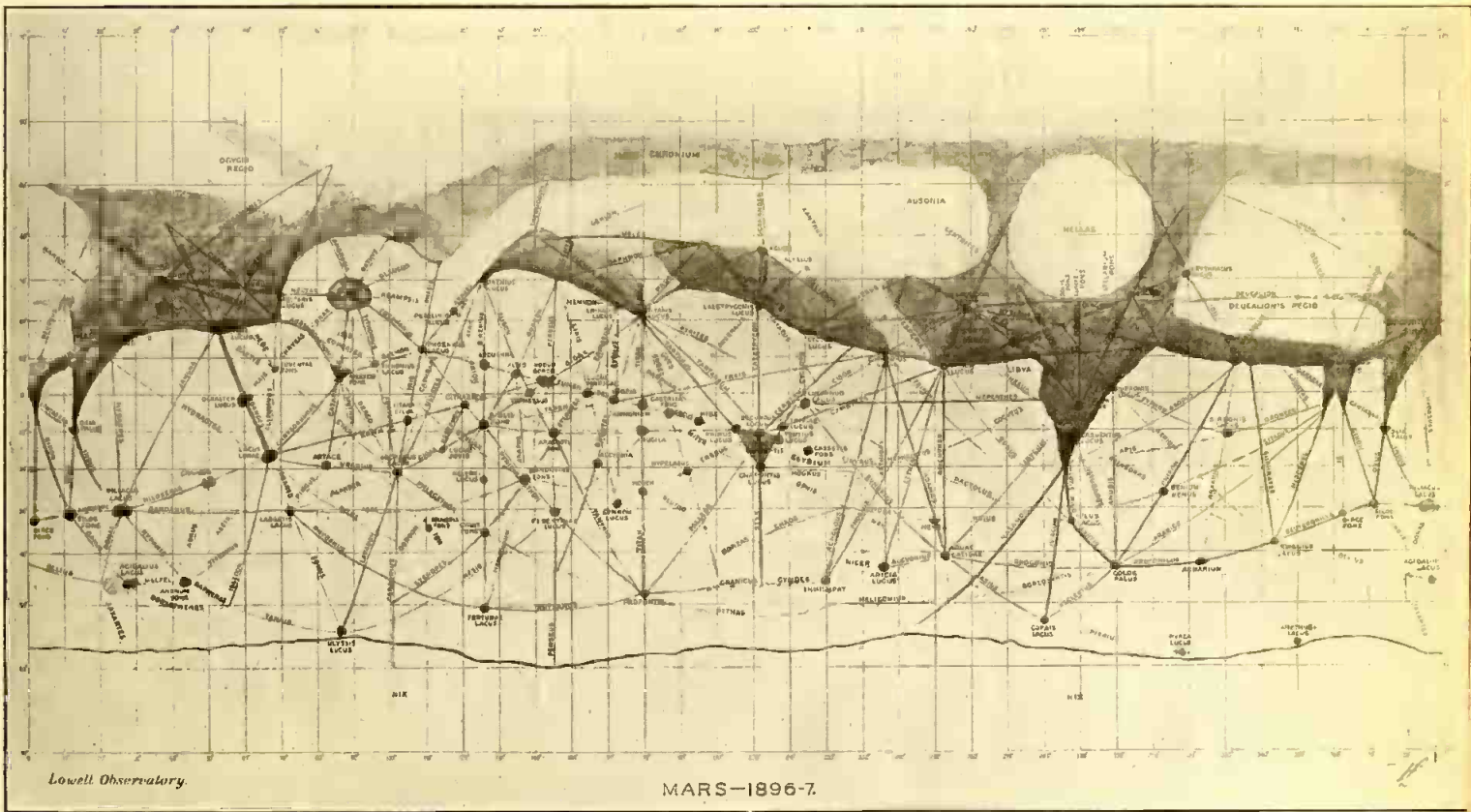

Photo courtesy Prof. Percival Lowell, Lowell Observatory, Flagstaff, Ariz.

The above map shows Mars and its canals in Mercator's projection. As objects appear upside down in the telescope, it should be remembered when studying the above map, that the top is South, the bottom North; East is left, West is right. Note how the majority of the canals run North and South (or South and North), toward the poles, which is necessary in order to convey the water from the melting polar snow caps equatorward. The canals can be plainly seen running over the dark areas, which are therefore

not seas, but vast stretches of vegetation. Particular attention is called to the numerous circular dark spots, only to be found at the intersection of two or more canals. These dark spots, termed *Oases*, are thought to be circular vegetational tracts, containing vast farms, parks, cities, etc.

The above map was made by Professor Lowell at the last opposition of 1896-7 when Mars was but 40 million miles distant from the Earth. The white regions at the top and bottom are the snowcaps of the poles.

motioned to us to close our eyes, which, of course, we did. The following then took place, and I will describe it as well as I can. No sooner had I closed my eyes than a clear picture of the Earth with its continents was flashed in my mind, just

nebulae floating in space and how the nebulae slowly became a solid sphere. The early life of Mars was then pictured, which must have been exactly like the evolution of our own Earth. We saw the prehistorical Martians with their clubs

nations. We saw the abolition of presidents and rulers over small and big nations, and the inauguration of a Universal Council and a Planet Ruler, both elected by popular votes.

"We witnessed how the once dense a

became thinner and thinner and how fertile valleys turned into deserts on account of lack of water. We saw the transmutation of the metals, as well as the transmutation of all other matter. Thus we were shown how iron or lead was turned into gold or copper, or into any other metal. Or else new marble or stone was turned into steel or gold or other metals, the same as clay can already be turned into aluminum on Earth to-day.

"Simultaneously with these discoveries, we witnessed the unlocking of atomic forces, which was the last great Martian discovery in the final mastery of the Planet.

"Where extermination had stared the Martians in the face on account of their constantly decreasing water supply, the new atomic engines, combined with the conquering of gravity, dispelled all fears for the future. During the next few generations we were made to see the creation of the monstrous waterways which not alone were to bring water from the two poles, but also were to irrigate existing agricultural districts as well as barren deserts. We saw how the Martians finally harnessed the Sun and how the latter was now moving the waters in the vast waterways, which you know as 'canals.'

"In quick succession we were then shown the past progress and evolution on Mars during the last thousand years. I do not attempt to go into details here, as you would surely not grasp the meaning. Neither do I attempt at this time to explain all the wonders that took place on Mars during the past 10,000 years, because you would not understand most of it, precisely as we did not grasp everything during our first 'lecture.' It therefore becomes necessary to explain the wonders to you by way of examples and comparisons with existing terrestrial terms. This I will do during our stay on this Planet.

"After our host had concluded his first 'lecture' he watched our utter amazement with the benevolent smile a fond mother will bestow on her four-year-old child after she has finished telling him a particularly interesting fairy story.

"After a short time we could understand him fairly well by his motions as well as by more picture talk without our eyes being closed. He then made us understand that he desired us to transfer our thoughts to him. Accordingly we tried the experiment. Flitternix's turn being first. He failed utterly, for our host shook his head smilingly. I then tried my hand, or rather my head at it. But as the metallic-like cap, which one of the Martians had placed on my head, made me too warm, I foolishly proceeded to take it off. Of course our host smilingly made me put it back again, and only then did I remember that he had shown us during our lecture that thought transference was impossible without the medium of the complex 'cap,' which I shall later describe to you.

"I then proceeded to concentrate my mind and began thinking real hard of Flitternix and how he appeared just then. For some seconds I did not seem to be successful, for our host looked blank. Finally, with the perspiration running down my forehead from the unaccustomed effort, the Ruler's face lit up and he pointed smilingly at Flitternix! I was much elated over this success. *my first transmission of thoughts, or rather one thought!* For a few minutes our host then tried to make us understand that it would take some days of practise before we could hope to even 'talk' by pictures, and perhaps months before we could begin to actually 'talk' in words without using our tongues or ears. He then recommended that Flitternix and myself should practise as much

as possible and to forget speech entirely. He also cautioned us that as all thought transmission took place through the medium of electricity, it was necessary that the flexible metallic cord hanging from our metallic-like caps should touch some conductor, preferably the ground. As we could easily guess that this was necessary in order to provide a return circuit for the currents we soon learned how to keep in contact with a conductor, when we wanted to transfer our thoughts from one to the other.

SYNOPSIS

I. M. Alier, an eccentric young scientist of Yankton, Mass., who claims as his own many new as well as startling inventions, far ahead of anything as yet discovered, owns the largest radio-telephone plant in the country. One evening he hears strange noises over his phones and immediately a sepulchral voice is heard. It is Münchhausen, one of the greatest yarn and story tellers of all times. Münchhausen explains how it came about that he did not die in 1797, as popularly thought, and he furthermore gives unrefutable proof that his home is on the moon at present.

Alier wants to know why Münchhausen went to the Moon and how. The latter then explains how Prussia persecuted him and how he went over to the Allies and succeeded in capturing Berlin in a wonderful manner. However, it was not a complete success, so the Baron left Europe for America. He immediately constructs a machine which is to take him into space to the moon. Münchhausen has discovered how to neutralize Gravity by means of Electricity, and he applies this invention to his space flyer, the "Interstellar." The machine proves a success; it responds and is lifted with tremendous speed towards the moon.

Queer things are discovered on the way to the Moon, among others that hodies lose all their weight inside of the "Interstellar." Finally a landing is effected on the Moon in a desert, but great hardship is encountered on account of the Moon's rarified atmosphere. The party then leaves for the nearest mountain range, where they discover a huge subterranean cave and a lake filled with luminous fish. Bread trees are also discovered. Münchhausen next gives a vivid description of the Earth, Sun and the firmament as viewed from the Moon; he also explains how the continents and oceans of the Earth appear from the Moon. He then tells of the ponderous meteors which continually crash down on the Moon. Finally one falls down near him and the resulting concussion hurls Münchhausen in a bottomless crater, which goes straight through the Moon. He falls clear through to the other side, but his momentum brings him back to the starting point, where he is saved by his companion. They then decide to depart for the Planet Mars, but they leave behind them an automatic Wireless Plant, the "Radiomatic," which will relay the messages from Mars to the Moon and thence to Alier. A popular lecture on Mars is also given by Münchhausen.

Within 36 days they arrive at Mars, but when they attempt to land, three floating forts capture the "Interstellar" by means of a yellow ray which henumbs them, and guides the "Interstellar" to the Planet Ruler's revolving mansion where a landing is effected. Flitternix speculates on the probable appearance of the Martians and gives his reasons on which he bases his assumption. Immediately after landing, the Martians place soft metallic caps on the travelers' heads, and they are then conducted to the Ruler's mansion.

This story started in the May, 1915, issue. Back numbers will be supplied at 10c. each postpaid.

"As our host had to go to the other end of the room just then for a few minutes, Flitternix and myself tried thought transmission at once, and we surprised ourselves how well it worked. Not only could we 'talk' in pictures almost at once, but after a while we could tell each other whole sentences. Of course, the unusual strain gave us a headache long before our host returned, which was only to be expected; we had never been used to such hard mental work, and we understood quickly that we must learn the art grad-

ually by constant slow practising and giving the brain a chance to recuperate from the strain.

"As if our august host had divined the strain on our minds during the past hour and one-half since our landing, he immediately began to divert us, and he did this admirably by letting us see for ourselves with our own eyes, instead of making us 'see' with our minds.

"However, we quickly began to understand and appreciate his wisdom in first giving us his historic lecture, because if he had not done this most of the things we saw during the next hour would have been meaningless to us. Thus you will understand that what I am going to tell you now, including the explanations, did not originate entirely in my own mind. Most of my explanations are, naturally, based upon that important lecture.

"We followed our host outdoors, where we boarded his private flyer. This machine was, of course, an anti-gravitational flyer, propelled by atomic engines. It behaved much like our own "Interstellar" that is, it had no wings, nor planes, because it is not dependent upon the air. The gravitational attraction of Mars is neutralized by the atomic engine to a certain degree. The more the gravity is neutralized the higher the machine rises. Now, in order to steer the flyer an *Emanation Ray* is used. This ray is the joint product of several elements not known on Earth; the nearest, although a poor analogy, is found in your Radium emanation, but the latter is several million times weaker than the Martian Emanation Ray. This ray is projected into space by means of electricity and another source of energy, which I shall term ION, as yet unknown on Earth, and to be described by me later. The Emanation Ray can be stored just as electricity is stored in a storage battery. When it strikes an immovable object it acts exactly as an oar does when the latter is used in 'pushing off' from a dock, i.e., the boat will move away from land. Precisely so with the Emanation Ray; it is used in controlling the horizontal motion of the gravity-neutralized flyer, and by its means the latter can be guided into any desired direction.

"Our flyer was round in shape, resembling a disc, and measured about 25 feet in diameter. It was almost 6 feet thick, and like most other things we had seen on Mars it was, of course, transparent. In the center was a dome that looked like the conning tower of a submarine, and a slender metallic pole extended from it almost 25 feet into the air. It branched out at the top into three short brackets, at the end of each was a transparent ball about 10 inches in diameter. Between these balls the Emanation Ray played, and the latter could be thrown at will into any direction desired.

"Our flyer was an open one and not covered on top, and there were two 'drivers,' which you probably would call chauffeurs, one forward and one aft. There were no steering wheels and no brakes, nor a horn. The two drivers sat in transparent chairs, not unlike our own, and in front of them was a little round table with small key levers like 'listening in' keys on an American telephone switchboard. That was all.

"As soon as we were seated, our host sitting between us, our 'drivers' pressed a lever or two, and we shot upward with amazing speed. In a few seconds the Emanation Ray went into action, and we began to fly or rather float into an easterly direction. From the position of the Sun, I concluded that it was almost 'Noon,' as the Sun was about overhead; this must

(Continued on page 442.)

How The "Wireless Wiz" Celebrated Xmas

By Thomas W. Benson

YES; I was burning the midnight oil, or rather *juice*, constructing a high-speed key for the "Wiz." I knew that he wanted this more than anything else and it had to be "some key." Time and money were no consideration, and neither was spared on this work of art. I was buoyed up to my task by the anticipation of the look on the Wizard's face when he would open the box and lift out the shining piece of apparatus on which I was spending so much time in making.

The noise I made in the basement was outdone by that in the ether, for my wrist

and, lo! a "wave meter" was revealed nestling in a bed of cotton batting. I reached forward to touch it, and—"ouch!"—I nearly dropped the whole thing. I grinned, for I had detected a soft, buzzing sound issuing from the box that explained everything. Using extreme care, and taking a few more shocks for good measure, I succeeded in getting the wave meter out of the box.

The "Wiz" had included a small but "hefty" medical coil and had arranged two clips that made contact as soon as the lid was removed. A few wires twisted around the box and one to the condenser had served

room was darkened, and half of it was taken up with a platform about two feet high and about six feet wide. On one end of the platform was a massive Christmas tree, slowly revolving, and at the other end was mounted a miniature lighthouse on the rocks, against which water appeared to be dashing. The platform was decorated to imitate a mountainous country in the wintertime, and over the whole scene hung a half-moon that vied with the ever-changing beams of light from the lighthouse for superiority.

On the edge of the platform were laid

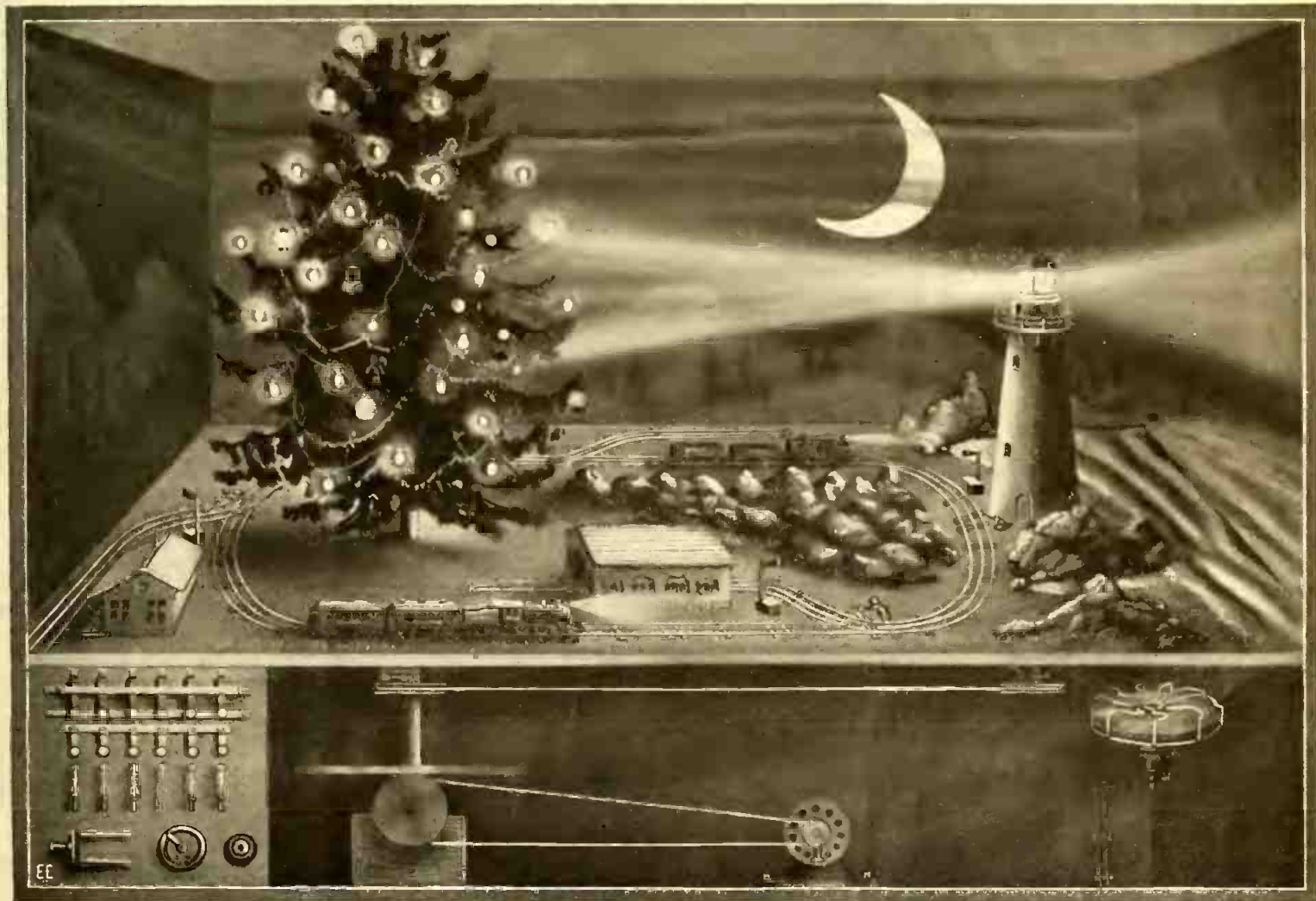

The "Wiz" Had Quite Outdone Himself. A Miniature Lighthouse Blazed Forth, While Toy Electric Trains Passed Each Other True to Life. The Tree Revolved While the Lamps on it Blinkd On and Off Repeatedly.

was nearly gone, returning the good wishes of the season via wireless. In disgust I had shot the closing signal and slid away to the haunts of the rats and cobwebs. The clock in the kitchen had struck one, yet I ceased not.

* * * * *
Time sped on, and that Saturday morning came at last, on which the world does honor to the birth of its Saviour. At six bells I kicked the blankets off and sat in, garbed only in my bathrobe and slippers, and nearly had the 'phones burned out by the disturbances in the ether which carried the good wishes that came literally pouring into the set.

I was the first one down that eventful morning and was waiting for the postman as he came whistling up to the door and fairly snatched the box out of his hand. I could not count the time in minutes or seconds that I consumed in opening the box;

to give me a *shocking surprise*. It was a wave meter that anyone would have been proud to own, and as I knew the "Wiz" had spent some time in his "Lab." constructing it.

After I had eaten my breakfast I went out to call on him and, of course, bumped into the usual Christmas morning crowd roaming around half-dressed. They appeared to be waiting for the "Wiz" to start something, and as I came into the room he said, "You're just in time for the ceremony. I'm taking the kids in to meet Kris Kringle."

He stood in front of the door leading to the parlor and clapped his hands. The door swung slowly open, and to the strains of a Christmas carol, played on the Victrola, we walked into the land of wonders.

Wonder is a pretty poor word to express my sensation when I beheld the work of art the "Wiz" had wrought over night. The

the gifts for the children, and with a shout of joy they dashed for them without waiting to pay any attention to the ever-changing, ever-flashing, vari-colored beams of light that made a charming scene; one indeed never to be forgotten. There was an electric curling-iron for the "Wiz's" sister, Olga. She left immediately with an abashed smile to try it out in the privacy of her own room. There was an electric chafing-dish for mother, and an electric shaving mug for dad, lying beside the usual collection of Teddy Bears and Trumpets that the kids were fighting over. I turned and saw them standing at the door with a smile that would not come off, and dad was feeling his jaw, to see if he was ready to test out the new shaving mug.

I looked for the "Wiz," as I wanted to compliment him on his work of art, but found him bending over a small switch-board, showing Joe how to dispatch the

trains on the railroad system. After watching the action for a few minutes, I was practically speechless. He had laid out a railway system which consisted of two stations and a side-track. By closing a switch

The tiny fir trees on the mountain side, the rising and falling of the semaphores, the whistling of the locomotives, all made such an enchanting scene that it was hard to realize that I was standing in a warm

the moon shone forth in all its glory, and the lighthouse once more sent its beams out to sea as I bade the "Wiz" farewell, to go my regular Christmas rounds.

As I left him I promised I would be back

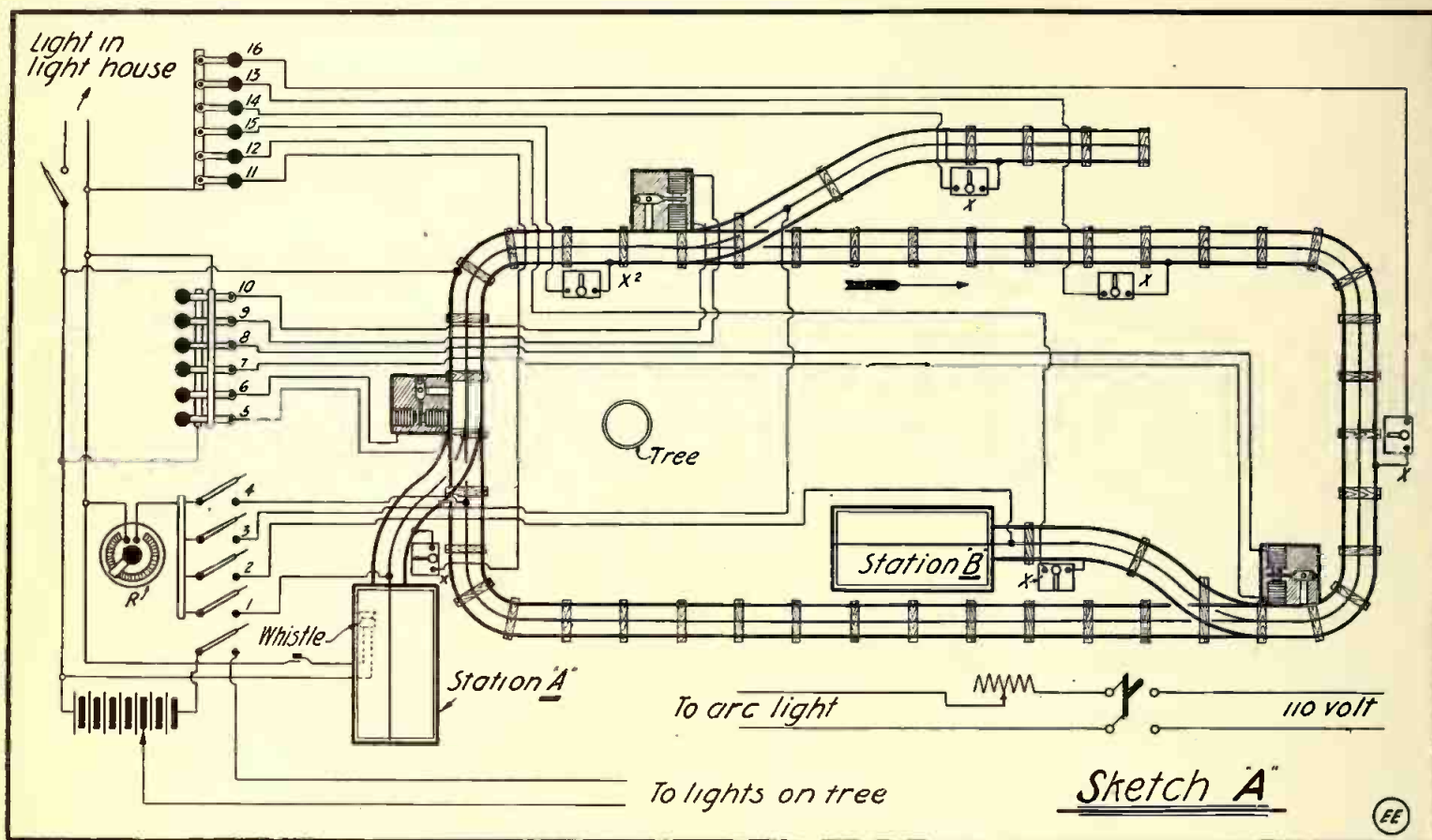

Complete Layout of Toy Railway Tracking, With Automatic Reversing Switches, Side-tracks, Stations, et cetera.

he would start a freight train from one station and simultaneously start an express train running in the opposite direction around the loop. It looked like a head-on collision, till he pressed a button, and the freight train would shoot on to a side-track and let the express through. After the express had reached the home station, the freight train would be backed off the siding and run to its station. This action could be changed indefinitely and many peculiar and exciting situations came up during the action. He would have the express train about to overtake the freight train when—click—the "freight" would be

room in the city, and not seated on a mountain top, surveying a picturesque mountainous seashore.

The moon was the final touch to the scene as it shed its pale rays on the landscape, and casting faint shadows just like a real moon. Mountains were painted on the back scene, and the moon appeared to be just rising over the peaks. It was the kind of moon that jewelers and housefurnishing dealers delight in, being an accessory before the fact of many of their sales.

The only object that would spoil this flight of fancy was the Christmas tree slowly turning, while among its branches were flickering numerous tiny lights, and the colored rays from the lighthouse lit up the tinsel and shining fol-de-rols on its branches.

I have seen Christmas trees, many of them, but they all lacked something. Something was always missing, a subtle, but perceptible something that all things should possess when used in the worship of a celestial Deity. They had the gaudy appearance that oftimes means cheapness and lack of refinement.

This tree, however, was decorated very simply, yet did not look bare. It turned slowly on its axis, as though it were showing you, but not without a little hesitation, the wonders attached to its branches, proud of them, but endeavoring to suppress its pride.

My attention was then attracted by the rocks on which the lighthouse was mounted and they appeared to be glowing in the semi-darkness. When the lamps in the lighthouse and tree were turned off and the moon had faded away to a faint glimmer, the rocks shone forth in the darkness in resplendent glory and the tree, revolving with its phosphorescent trimmings, put the final touch to the enchanting picture. Again

for the full details of this wonderful display, and asked him what he had received in the line of presents. With a half-depreciating smile, he replied, "Well, old man, outside of your high-speed key, I got a couple of pairs of slippers and a smoking cap, besides several boxes of those famous or, rather, infamous Christmas cigars. I

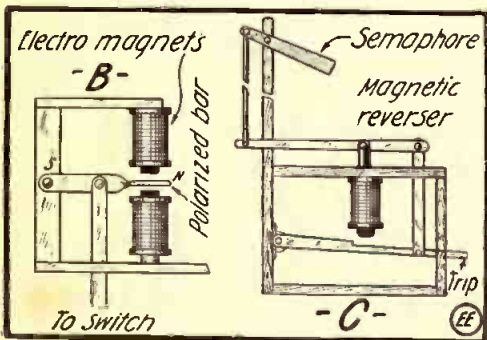

Detail Sketches "B" and "C."

switched out of the way, with only two inches to spare.

The action was quite natural, for the trains would blow their whistles and emerge from the stations with headlights flashing, glittering on the imitation snow, and with a little stretch of imagination the beholder could readily believe himself on a mountain peak looking down at a scene in one of our many inlets in New England during the winter.

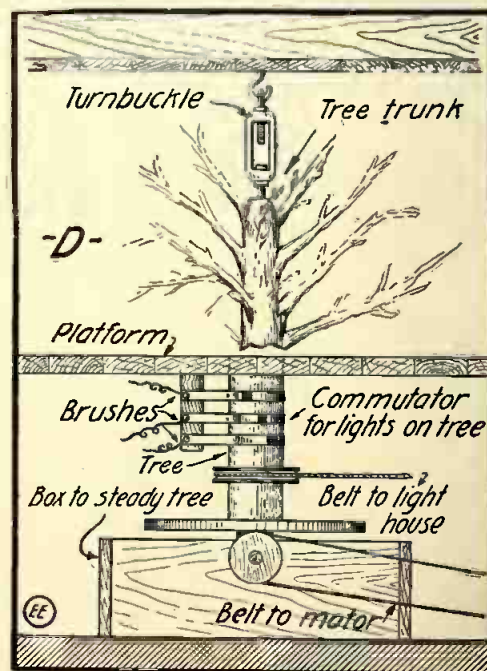

Detail Sketch "D," Showing Suspension and Base Mounting of Xmas Tree.

haven't had time to open all the packages yet, though."

(Continued on page 397.)

Buying By Mail

By Thomas Reed

I WONDER who the wise man was who first discovered that a boy's trade was worth having. As I look over the experimental supply catalogues of the present time—with everything that a "bug" could want pictured out so exactly, offered in the smallest quantities, and priced so cheaply—I am reminded of the humble figure we "old bugs" used to cut in the "marts of trade."

Those marts certainly bore us in no high esteem. It was a dreaded ordeal for us to meet the lordly hardware clerk and presume upon his august attention for five cents' worth of copper wire, or a quarter of a foot of brass rod. Our reception varied from an amused indulgence that made us afraid to come again, lest we wear out so kind a welcome—down through a snappish compliance that usually carried a crushing overcharge—down, down to the icy depths of "we don't deal in such small quantities."

How many times I have timidly inquired the price of some coveted material, such as copper burrs, to receive the answer: "So much a pound." A pound! A vast, uncertain quantity that would make me the envy of my fellow "bugs" in that one particular and bankrupt otherwise! The word "pound" gives me a shiver to this day.

And people never sold finished parts. "Oh, no," they said, "we're too sharp for that. If you could buy that one impossible piece, you would make the whole article, and we should lose a sale." Such was the logic of merchandising then. So the "boughten" commutator that we wanted to put the finishing touch on our home-made dynamo remained unbought. But what booted it?—as Shakespeare was wont to inquire. We found a substitute; and the stingy vendor, instead of selling a thousand commutators, sold no dynamos, or few, and disappeared from the haunts of men.

You lucky "bugs" of later times, take a day off and use it to realize your blessings. You can buy a single milled nut, or an inch of Wollaston wire, or ten cents' worth of galena crystals, and have them delivered at your door, and not grudgingly, but with a hearty "thank you; come again." And parts? "Why, sure; make all of it you can, and buy the rest from us." The best in the house is none too good for the amateur now.

The mail order! There can be great discoveries entirely outside of the physical sciences. The modern mail-order system is as truly an invention as the gas engine and, like it, was formed from several contributory sources. The development of illustration through the photographic half-tone and the machine-line engraving was necessary for the exact description of goods by catalogue. But another factor, intangible though it is, was requisite before the system could be a success—an insistence almost fanatical on the square deal.

It is greatly to the credit of the mail order that it lived down the errors of its youth. Way back in the '70s it was in decidedly ill-repute. The picturesque ex-

pression "Stung!" had not been added to the language, but the sting was certainly among those present in all advertising columns.

Those were the days of shin-plasters. Do you know what "suspension of specie payment" means? Say no, and say it with gratitude. Uncle Sam was paying his heavy war expenses in paper money, and Uncle's gold and silver coinage had fled from the light of day. That's what economists call a necessary consequence, and you have to take their word for it; but I saw its inner workings. Whenever I peeped into the family strong-box I saw there a little roll of silver "quarters," hoarded since the beginning of the war, when the word went round that they would be "worth a premium."



" * * * It was a Dreaded Ordeal for Us to Meet the Lordly Hardware Clerk * * * to Purchase Five Cents Worth of Copper Burrs."

Mother had put them there, and I think her most reasonable hopes of profit took the form of a walnut chamber set. Mother was speculating. Dear old mother, she never speculated on anything else, except on the love and loyalty of her children; and sometimes, I fear, she must have placed those in the same disappointing category as the silver quarters!

So we used "fractional currency"—little young paper bills, about three inches by two, representing 50 cents, 25 cents, even 10 cents; and, believe me, even that humble form of money was hard to get. Boys had no "allowances" in those hard times—except the allowance to have nothing; but deep down in the boy-world there was a system of trade and finance. We collected rusty nails, swapped knives. Instead of stock transactions, we played marbles "for

keeps"; though I assure you no dealings were permitted on margin. Well, this boy-wealth, accumulating as slowly and painfully as any other wealth, eventually blossomed into the small copper coin of the upper realm, finally to ripen into the glorified fruit of fractional currency. I have had the pleasure since of gazing upon a rather large banknote (not mine, to be sure—it was for \$50,000, or such a matter), but it entirely lacked the haughty impressiveness of my first 25-cent shin-plaster.

And even while I gloated over my magnificent aggregation of capital, frenzied finance got it. I can see that seductive advertisement now, picturing a bewildering medley of articles—a printing press, a Japanese parasol, a trick spider, and a dozen other lures of childhood—all for exactly my fund of 25 cents. Wonderful coincidence, the chance of a lifetime. Really worth \$1. Sell them for their real value and grow rich.

The old folks were sceptical—the Pacific Bank, it seems, had spoken in some such strain—but I knew better. Good-night, 25; a fond farewell! To New York it went, and for days I waited, each day a year long. With every rumble of a wagon I was at the window to see the express package trundled in. It was the postman, however, who handed out a box two inches by four—plenty large enough to contain a world of woe. Every article was there, *but in miniature form*—toys for a baby to suck the paint off, not goods commanding traffic in boy-commerce. The advertisement had not mentioned that detail. I was face to face with the dreaded "ketch."

I considered my young life blighted, of course, but it might have given me some comfort had I known that the mail order was blighting itself as well. It took a generation of time, strict laws, and the teaching of experience that honesty is the best policy before the mail order, in partnership with the square deal, came into its own.

You young "bugs" really don't fully appreciate how good the world treats you these days. No more "ketches" in these days of watchful post-office inspectors, no sir-e-e! When you stick your money order with your letter in the envelope, and send it off to that big mail-order house, you know just how long it will take till the postman hands you that pair of long-coveted "classy" 'phones. And, believe me, "bugs," those 'phones will be a whole lot better than the cut showed, or the description read. And on top of this, if you're finicky and don't happen to like them, why of course you send 'em back. And in due time the mail order returns your money, if you want it.

Take it from an old "bug," you young "buglets" have lots to be thankful for.

The largest electric range in the world has been placed in the Montana State Hospital at Warren Springs, Mont. The range is more than 30 feet long. It is equipped with eight ovens and will prepare meals for more than 1,500 persons daily.

To Foil Submarines With Undersea Searchlights

THE submarine and mine constitute two of the greatest menaces to warships and other vessels under modern war-time conditions and to offset the utility and efficiency of same has interested many inventors both in this country and abroad. Inventors and scientists have advocated from time to time various methods whereby they hoped to render the submarine at least an obsolete engine of destruction.

What bids fair to be a successful combatant of these submerged terrors of the sea is the invention recently brought out by Prof. Herschel C. Parker and Edwin G. Hatch, of New York, mechanical engineer, associated with Prof. Parker in his engineering and research projects.

The accompanying illustration will give

communicated to the gunner, who then discharges a special form of projectile resembling a torpedo. This projectile, of course, is so aimed as to strike the mine or other submerged device, and it is not detonated until it is close to the submerged body proper. It is then exploded by the gunner, who closes an electric switch, causing a current to flow along the attached wires to the projectile, fusing a fine wire detonator inside the missile.

On first sight this invention may seem to be a mere theorist's dream, but from tests that have been made in the taking of pictures under water by means of a powerful searchlight, it is definitely asserted that submerged objects can be seen in this way for distances of from 1,000 to 2,000 feet. These distances, of course, may be greatly

tration shows, so that a protection would be afforded the gunner and sighter from ordinary rifle and machine gun fire.

For details regarding this latest scientific invention for the detection of submarines, etc., the following considerations will help to make clear the *modus operandi* of the apparatus in general:

At the top of the tube, the latter being represented by the figure 10 in the diagram, is a powerful electric searchlight 11, of any approved kind, which throws its rays through lenses 12 and 13, arranged to hold the rays in parallel relation. These rays are directed against a mirror 14, which is arranged at an angle at the lower end of the tube, and refracts the rays through the lens at the outlet of the tube. This latter lens can be shaped to throw the rays in

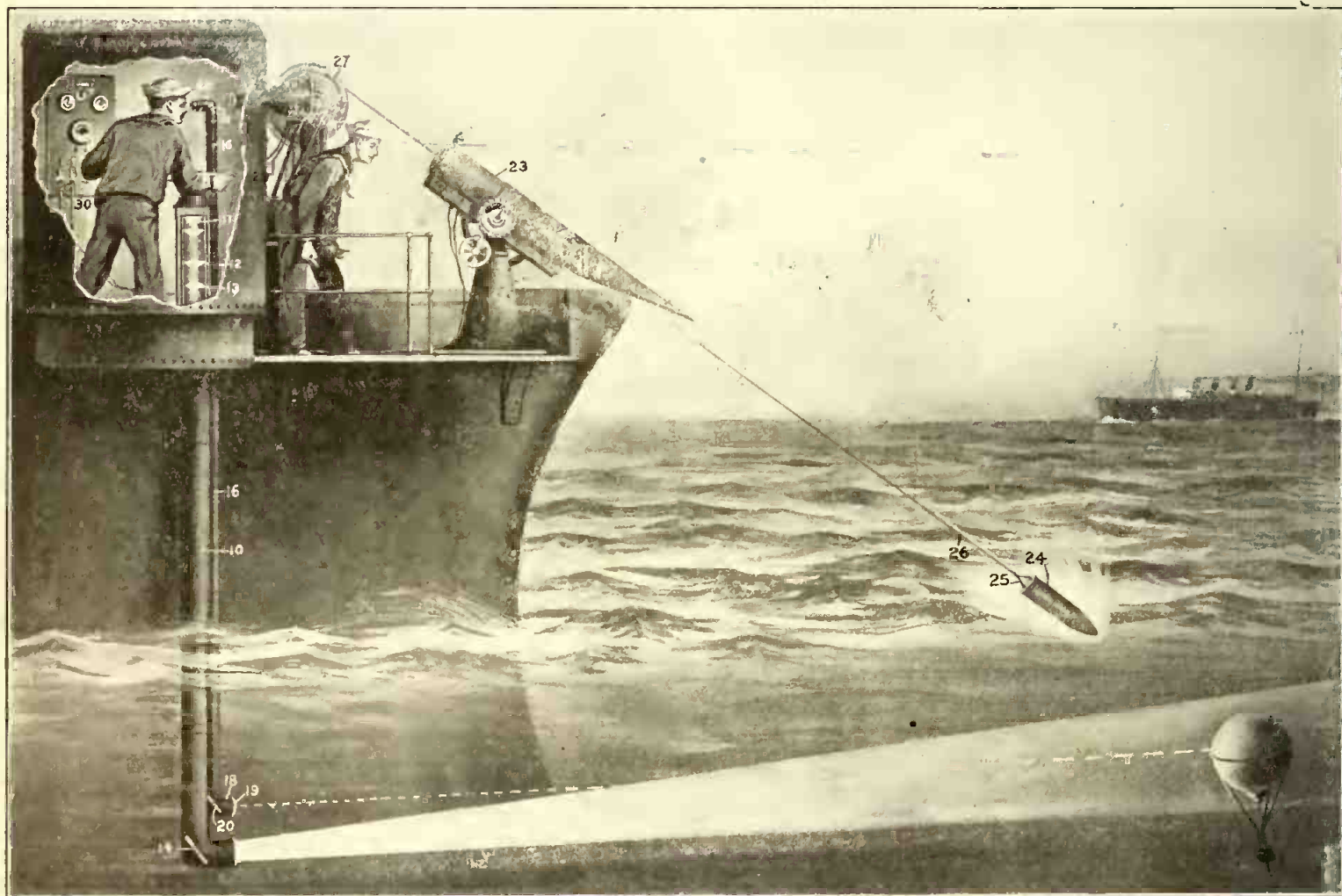

Latest Scheme for Locating and Destroying Submarines, Mines, etc., by Means of a Powerful Under-Water Searchlight and Periscope Device. Developed by Prof. Herschel C. Parker and Edward G. Hatch, M. E., of New York.

an adequate idea as to the method of utilizing this arrangement as perfected by Messrs. Parker and Hatch. Simply explained, it makes use of a powerful searchlight beam which is projected through a suitable focusing tube, fitted with reflecting lenses and mirrors and an instrument termed a *mariscope* (but really the same as the periscope used on all submarines) is used to sight through the water along the light beam, aforementioned, and which is turned about on the axis of the projecting tube until it intersects a hidden mine, the hull of a submarine boat, etc. When the mine, or other engine of destruction, is accurately located by this apparatus, the range of same, as well as the angle at which it lies from the hull of the war vessel, is measured accurately by scientific instruments, such as used on regular cannon. These angle and range figures are

increased by using a proportionately greater amount of energy in the searchlight projector. The larger projecting tube, into which is fitted the searchlight lenses, mirrors, etc., is termed a *helioscope*, and the instrument mounted in the smaller sighting tube through which the submerged body is viewed is called a *mariscope* by the inventors. In the illustration herewith given it is, of course, to be taken into consideration that the proportionate distance between the mine and war vessel proper is quite close, but in practise the distance would naturally have to be greater than that shown, for the reason that the explosion from such a device would affect the vessel undoubtedly unless it was more than 300 feet away. If this device is actually tried out and adopted by the navy it would have to be arranged most probably in some such manner as our illus-

parallel relation or to give any amount of divergence desired.

The tube, with the searchlight, lenses and refracting mirror, is attached to the outside of the vessel. Inasmuch as the searchlight is to be used on deck, a light of the highest power can readily be used. The tube can be adjusted so that it may be raised or lowered to bring the light to any desired point. Likewise the mirror can be moved for the same purpose, but the details of this adjustment have not as yet been considered exhaustively, because they do not concern the general scope of the invention. If a light is projected on both sides of the bow, the field which it is possible to light is almost equivalent to the field of human vision.

When the submerged field is lighted, the next step is to observe it properly, and to
(Continued on page 450.)

By Wireless 'Phone from Arlington to Paris

THE spoken word uttered in Arlington, Va., has been heard in Paris, France, on three different occasions recently, and particularly on the evening of Oct. 20 last. On that memorable date the human voice was projected across the Atlantic for the first time in history, and "Hellos" and "Good-byes" spoken in Arlington were heard and understood in the French capital, 3,800 miles from the point of transmission.

Announcement of the epochal achievement was made officially by the American Telephone & Telegraph Co., following cabled confirmation of the success of the wireless telephone experiments received in New York and in Washington from the company's engineers in Paris.

H. E. Shreeve and A. M. Curtis, of the staff of John J. Carty, the chief engineer of the American Telephone & Telegraph Co., went to France to represent the company in the transatlantic experiments.

Owing to the fact that France is at war and that wireless is playing a most important part in the working out of the French military communication system, it was with extreme difficulty that officials were persuaded to permit the use of the 1,000-foot Eiffel Tower station at Paris for the receipt of the radiophone messages from Arlington.

Only a few seconds at a time, in periods far apart, were allowed the American engineers, during which they were permitted to listen for the greeting from far away Arlington. In order that there could be no doubt of the genuineness of the tests, officers of the French Government, two or more of whom represented the army, were with Messrs. Shreeve and Curtis in Paris, while Colonel Samuel Reber, of the United States Army Radio Service; Captain W. H. G. Bullard, head of the United States Naval Radio Service, and other American army and navy officers watched intently the experiments at Arlington.

Mr. Carty, who not only heads the engineering staff of the telephone company but is president of the American Institute of Electrical Engineers, directed the experiments. Following the announcement of the success of the tests, he predicted that wireless telephonic communication between New York or any other American city and all the great cities of the world was but a matter of time.

The announcement given out at the offices of the American Telephone & Telegraph Co. follows:

"Transatlantic wireless telephony is an accomplished fact. Observers listening at

the Eiffel Tower in Paris have heard speech sent out by engineers of the American Telephone & Telegraph Co. from apparatus developed by that company and the Western Electric Co. and installed at Arlington, Va. The equipment used was that employed a few weeks ago in talking 4,900 miles by wireless telephony to San Francisco and Honolulu."

That speech has actually been transmitted from Arlington to observers stationed at the Eiffel Tower, Paris, marks the conclusion of another chapter in the experiment undertaken by the American Telephone & Telegraph Co. When Mr. Carty's engineers commenced work on the long-distance wireless telephone experiments observers with receiving apparatus were sent not only to Panama, San Diego, Mare

interference from high-power stations in the neighborhood and from static disturbances, speech was successfully transmitted on several occasions since.

In a cable message received by Mr. Carty concerning the results of the tests, Mr. Shreeve reported speech received by him and the time of its reception at Paris. The matter received at Paris was that sent from Arlington, where R. A. Heising, B. B. Webb and other telephone engineers were manipulating the apparatus at the transmitting station. Mr. Webb did the talking throughout the final experiments.

Simultaneously with the reception at Paris, speech sent out from Arlington was received on the wireless antenna at the Western Electric laboratories in New York and at the temporary station of the American Telephone & Telegraph Co. at the Pearl Harbor Navy Yard, Honolulu. Mr. Espenschied at Honolulu reported that he heard the conversation throughout the entire schedule and that Mr. Webb's voice was easily recognized.

After the announcement was issued Mr. Carty, who was in Chicago, was called up on the long distance telephone and asked to tell the story of the achievement.

"Tell us all about the Paris achievement," said an officer of the company in New York.

"Is anybody 'listening in?'" Mr. Carty asked, quickly guessing that newspapermen also were at the New York end of the line.

Mr. Carty laughed when told he had guessed rightly, and after a little persuasion told the story of the test.

"It was on the night of Oct. 12 when the first signal from Arlington was

caught by Shreeve, in Paris. Shreeve heard the 'Hello' of Webb at Arlington several times. Again, the following night, the words were heard, and on Oct. 20 the words were again heard, not only in Paris, but in Honolulu, by Lloyd Espenschied, who cabled to-day that he heard the 'Hello, Shreeve,' and the 'Good-bye, Shreeve,' uttered by Webb in Arlington so plainly that he was able to recognize the voice as that of Webb.

"The announcement of the success of the experiment was deferred through courtesy to the French Government, and it was not until Oct. 22 when further cable confirmation of the success that has attended our efforts made it possible for us to take the public into our confidence and tell what has taken place.

"While Webb was talking to Shreeve he repeated the 'Hello' and 'Good-bye' several times, and they were heard each time in
(Continued on page 448.)

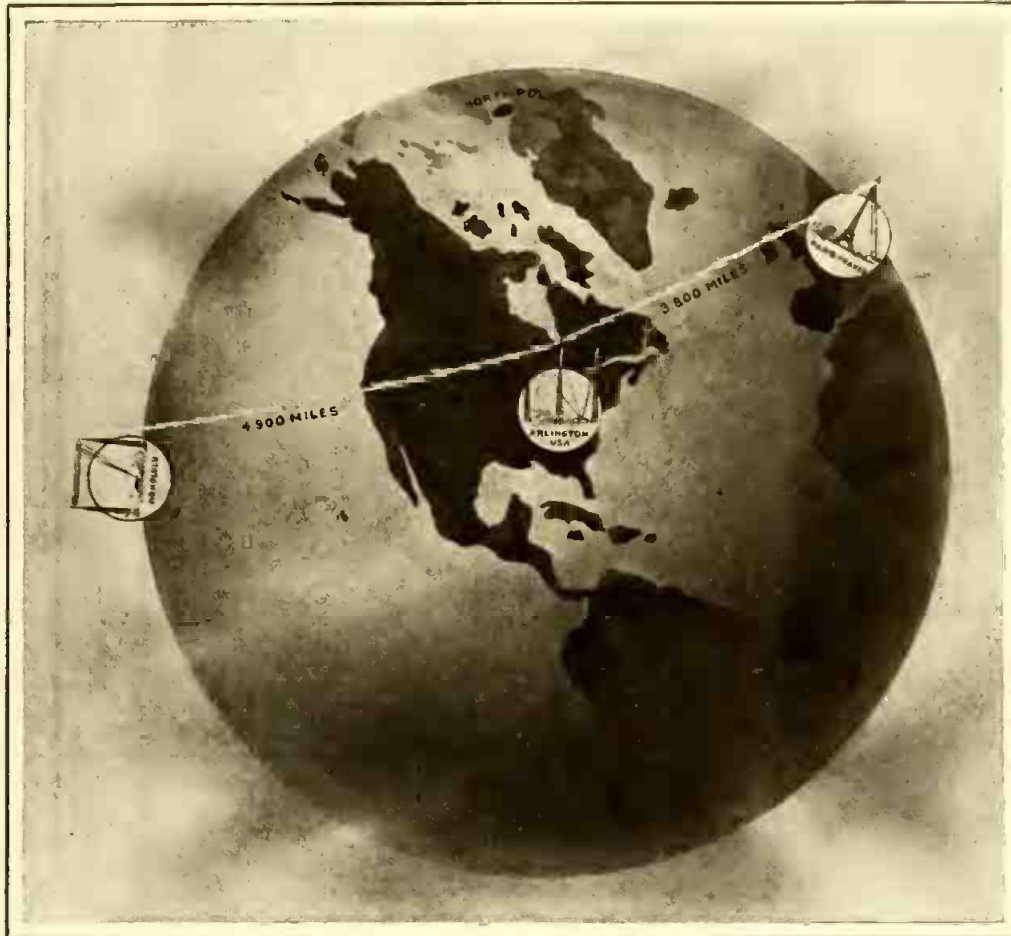

Graphic Illustration of Arlington to Honolulu and Arlington-Paris Radiophone Tests Recently Conducted; the Distances Covered Being 4,900 and 3,800 Miles Respectively.

Island and Honolulu, but also two engineers, H. E. Shreeve and A. M. Curtis, were sent to Paris. Through the courtesy of the French Government, limited facilities for listening at the Eiffel Tower station were placed at their disposal.

Full appreciation of the interest and extreme courtesy of the French Government can be understood when the great value of the Eiffel Tower station for military purposes is remembered. Due to the military necessities, the amount of time available for the wireless telephone experiments was so limited as to constitute a serious handicap to a speedy completion of the work. Added to this was the handicap resulting from the fact that all regular communication between Mr. Shreeve and the engineers in America had to be by cable and was subject to long delays.

Notwithstanding the difficulties of communication, the limited amount of time available for receiving, and despite heavy

Audion Bulbs as Producers of Pure Musical Tones

By Dr. Lee de Forest

NOW that the attention of the public has been drawn to the astonishing use of the incandescent vacuum lamp, not only as a receiver in transcontinental wireless telephony, but as a generator of power necessary to transmit the voice in the first place, it may be interesting to know that this incandescent lamp, or "audion," has another entirely different field of utility—that of producing sound or music. Music from light—that, in a word—is the latest magic of this lamp.

Tradition has it that on the plains of Egypt three thousand years ago the giant statue of the Menni emitted weirdly beautiful notes when struck by the first rays of

phone detector and incidentally as an amplifier to be used on long distance telephone lines I made the discovery years ago that when the circuits of the audion were connected in a certain way a clear, musical note was heard in the telephone receiver, which was connected in one of these circuits. The quality of the note was very beautiful, and I found after a little experimenting that I could change this quality of timber into a great variety of sounds, imitating, for example, the flute, oboe, cornet, stringed instruments and other sounds which, while pleasing to the ear, were quite unlike those emitted from any musical instrument with which we are familiar. The

of altering the pitch and quality of notes.

Acting on these discoveries and suggestions I found it was a comparatively simple matter to arrange a crude scale similar in function to that of an organ, with switches in place of the ordinary keys, so that by pressing certain keys I could cut out, or in, more or less inductance or capacity or resistance, thus changing the notes emitted from the telephone receiver at will.

In order to bring the volume of sound out large and full in the room it was necessary to connect a number of loud speaking horns connected with telephone receivers similar to those which you have sometimes heard in the central railroad stations as

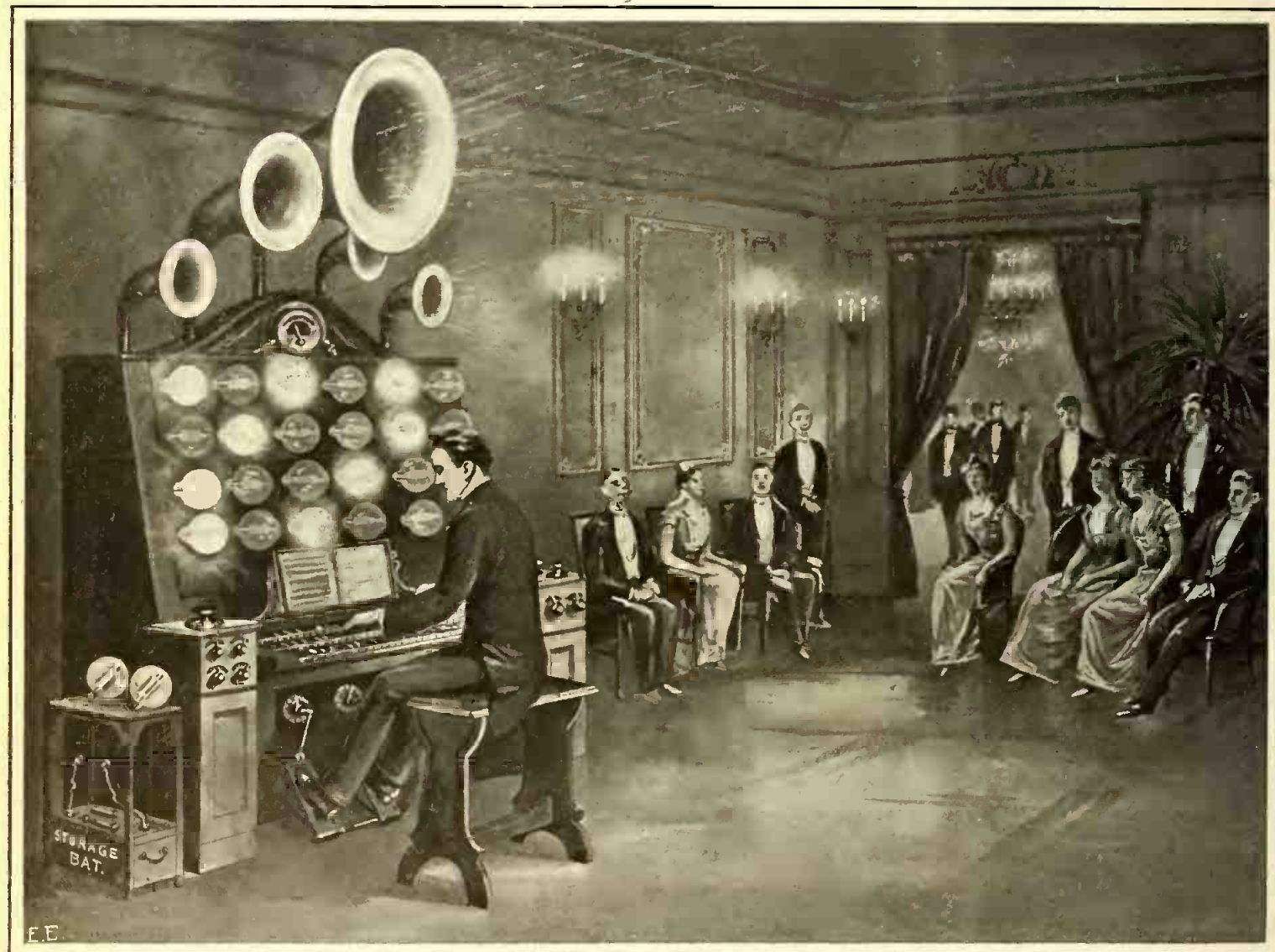

The Audion Piano May Entertain Us in the Near Future With Music Purer Than That Obtainable With Any Instrument Now Available. Also it Will Imitate Faithfully Any Orchestral Piece.

the rising sun. To-day, after three thousand years, it is interesting to know that we have at last reached the point of transmitting light rays directly into sound waves; that which has hitherto been only for the pleasure of the eye can now be made a pleasure also to the ear.

In my laboratory there are a number of small spherical incandescent bulbs, from which I am able to obtain a succession of musical notes, clear and sweet, of surprising volume, the pitch and timber of which can be varied almost at will to imitate any musical tone of an orchestra. Here, then, in the laboratory we have for the first time the music of the lamps.

While working on my experiments in developing the audion as a wireless tele-

phone detector and incidentally as an amplifier to be used on long distance telephone lines I made the discovery years ago that when the circuits of the audion were connected in a certain way a clear, musical note was heard in the telephone receiver, which was connected in one of these circuits. The quality of the note was very beautiful, and I found after a little experimenting that I could change this quality of timber into a great variety of sounds, imitating, for example, the flute, oboe, cornet, stringed instruments and other sounds which, while pleasing to the ear, were quite unlike those emitted from any musical instrument with which we are familiar. The

pitch of the notes is very easily regulated by changing the capacity or the inductance in the circuits, which can be very readily effected by a sliding contact or simply by turning the knob of the condenser. In fact, the pitch of the notes can be changed by merely putting the finger on certain parts of the circuit or even by holding the hand close to parts of the circuit. In this way very weird and beautiful effects can be obtained with ease.

train announcers. With these horns distributed in different parts of my laboratory, or grouped together in one place, the sound can be made to emanate from all quarters of the room or from one corner, as I choose.

In producing pure musical tones with an ordinary audion detector bulb, or with the special large size audion oscillator bulbs, the arrangement is shown diagrammatically herewith. At A there are placed in circuit two inductances, inductance No. 1 being of adjustable value, while inductance No. 2 has an iron wire core within it and also has taps taken out at equidistant numbers of turns to E connected to a series of switches or keys (and it is well to use, say, eight keys corresponding to a musical oc-

tave, thus giving eight notes). Of course, to produce more tones it is necessary to use more inductance taps, or condenser No. 3 may be of the adjustable type, so as to produce a variation in the musical tones developed in the circuit.

Using an ordinary audion detector bulb, the high voltage battery No. 4 may give 45 to 50 volts, composed of the ordinary 3-cell flashlight batteries. Where the large size oscillation generator bulb is employed 110 volts D. C. is adaptable to this part of the circuit. A D. P. D. T. throw-over switch may be used, as shown in the diagram, to throw the tone-producing audion on to a pair of ordinary radio receivers or on to a loud-talking receiver. The experimenter who wishes to try out this arrangement should try making different adjustments in the circuit, including the filament current applied, until the best results are obtained.

Several years ago, as the public of New York remembers, a very elaborate undertaking was started for producing music by gigantic electric dynamos mixing the tones from 100 or more machines in accordance with the wishes of the skilled performer who in that way produced musical tones of large volume, and which simulated almost those of every instrument in an orchestra. This instrument was termed the telharmonium. The idea was to generate this music at a central station, where highly trained organists were constantly at the keyboard, and distribute it through telephone wires throughout the city to hotels, restaurants, lobbies, concert halls and private residences. This was a most meritorious idea and deserved great success. However, the extraordinary heavy cost of the original plant, the maintenance of the wire cables, etc., rendered it commercially a failure.

Now, with the audion or incandescent lamp as a generator of musical tones, we have on a small scale all of the possibilities of the large telharmonium.

Now, this same little bulb which I have just described, in addition to being a receiver of wireless messages and an amplifier for long distance wire telephones (in which use it is now employed on the transcontinental lines of the American Telephone & Telegraph Company), can be made to actually generate alternating current. It receives the energy which is expended in these currents from the dry battery or dynamo. The audion is, in other words, a transformer of energy. The alternating current, if of low frequency, can actuate the telephone diaphragm and make musical notes which the ear can hear, and this is the germ idea involved in the musical instrument which I have just described. The bulbs for musical purposes which I have thus far used are not larger than three inches in diameter.

At the present time I am using one bulb for an octave on the musical scale, with the arrangement of keys and switches such that from this one bulb I can produce the notes of that octave by pressing the appropriate keys. For the next octave another bulb is used, and so on. The output of all these bulbs is made common to one set of telephone receivers or loud speakers, so that the total energy in the form of sound is that of all the bulbs which are operating at any one time.

In the same way when used as a wireless transmitter or generator the high frequency alternating current from the various bulbs is combined on the same transmitting aerial wire or antenna. Thus, if one oscillator is "developing" one-half horsepower 300 of these bulbs connected in parallel and acting on the same antenna will develop 150 horsepower. This is ex-

actly the method which is used at Arlington by the Western Electric Company in generating sufficient energy to send the voice via radio to Honolulu.

In all my work with the audion—and I

effect variations in the audion bulb circuits. Each bulb is capable of producing an octave or eight notes. The large keyboard similar to those used on organs is well suited to this instrument, with which it will become



Above: Dr. de Forest's Laboratory Where the Musical Audion Bulb Was Developed. The Large Tubes are Cooled by a Fan as Perceived. Note Elaborate Tuning Variable Condensers in Foreground.

At Right: Close View of de Forest Audion Oscillator Bulb, with Tuning Condenser in Case. Some of These Tubes Measure Seven Inches in Diameter. They Actually Generate High Frequency Oscillations.

can imagine no device in the whole realm of practical physics of greater fascination than this little audion principle—I have never found any phase of its unlimited possibilities quite so interesting as this of producing musical notes. Although not a musician myself, I have always been exceedingly fond of music. The idea of producing beautiful musical tones by an entirely new method unknown to all our great composers and perhaps offering to future composers new fields for their genius, has truly captivated me. In the next twelve months I hope to be able to produce an instrument which will be far enough perfected so that I can turn it over to musicians to work out the thousand and one details of musical perfection which such men alone are capable of introducing.

The illustration here presented as worked out by the editor of this journal shows the probable appearance of an "Audion piano" of the not far distant future, utilizing the de Forest musical tube principle, by which means it is possible to produce the purest tones of any value ever obtained by any existing means. The various controlling handles are observed on the front of the

possible to reproduce imitations of any band, orchestral or stringed instrument, etc. Extra oscillator bulbs for emergencies for use in case one should break, are seen lying on the stand at the left. It should be thoroughly understood that music produced by such an instrument as this is much purer in every way than that produced by any other type of musical instrument now known to the art and, moreover, the music is electrically produced in contradistinction to that produced by the usual musical pieces which yield sounds mechanically, so to speak.

PENETRATIVE POWER OF COLORED LIGHTS.

It may interest those engaged in sign lighting and signaling to know that lights of different colors show varying degrees of ability to penetrate the atmosphere. Some calculations, based on experiments, give the following results for the minimum intensity visible in a clear atmosphere at a range of two miles. (In these calculations light sources of equal area are assumed.):

Red	2.37 candle power
Green	1.96 " "
White	1.71 " "

The range of visibility of any light source depends, of course, upon the intensity of the source. However, it must not be supposed that by doubling the intensity the range will be doubled. The relation between the range and intensity varies for different colors.

The great absorption of light in an atmosphere laden with water vapor is a well-known fact. A few years ago the German Government found that arc lights of 1,000,000 C. P., which were installed in a lighthouse, had less ability to penetrate a fog than a 10,000 candle power oil lamp. This indicates that electric incandescent lamps having more red rays would be superior to arc lamps for use in light-houses.

Dust and smoke unquestionably interfere more with the transmission of blue or green light than with red light. Therefore, when viewed through the atmosphere, all lights should appear redder. On weighing the evidence, it seems that reddish illuminants should have more penetrative power than bluish lights, and where details are to be distinguished at a distance the red light is more readily focused than by any other color. Hence the use of red danger signals on ships and railroads.

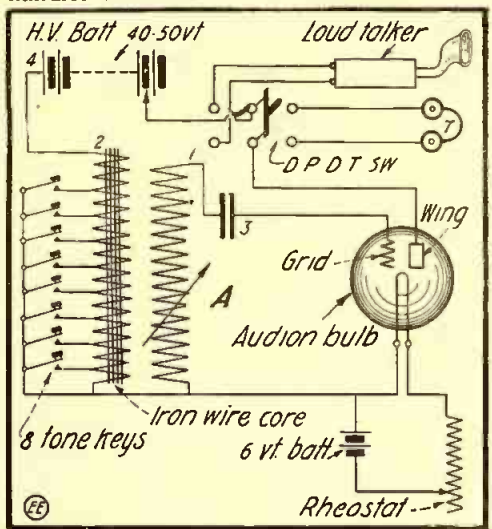

Diagram of Connections for Creating Pure Musical Tones with Any Audion Bulb.

piano, and the music is emitted from the large horns on top of same. A storage battery of small size will supply sufficient current for this wonderful instrument, and the feet might be utilized in assisting to

Wireless Telegraphy Aids the Teutonic Allies

The photographs presented herewith illustrate some of the up-to-date wireless telegraph equipment in use by the German army and also by the Turks. The smaller photograph shows a complete Mar-

The larger illustration shows a telescopic steel radio mast which can be elevated to a height of 100 feet very rapidly, and the machinery for performing this work is mounted on the truck here de-

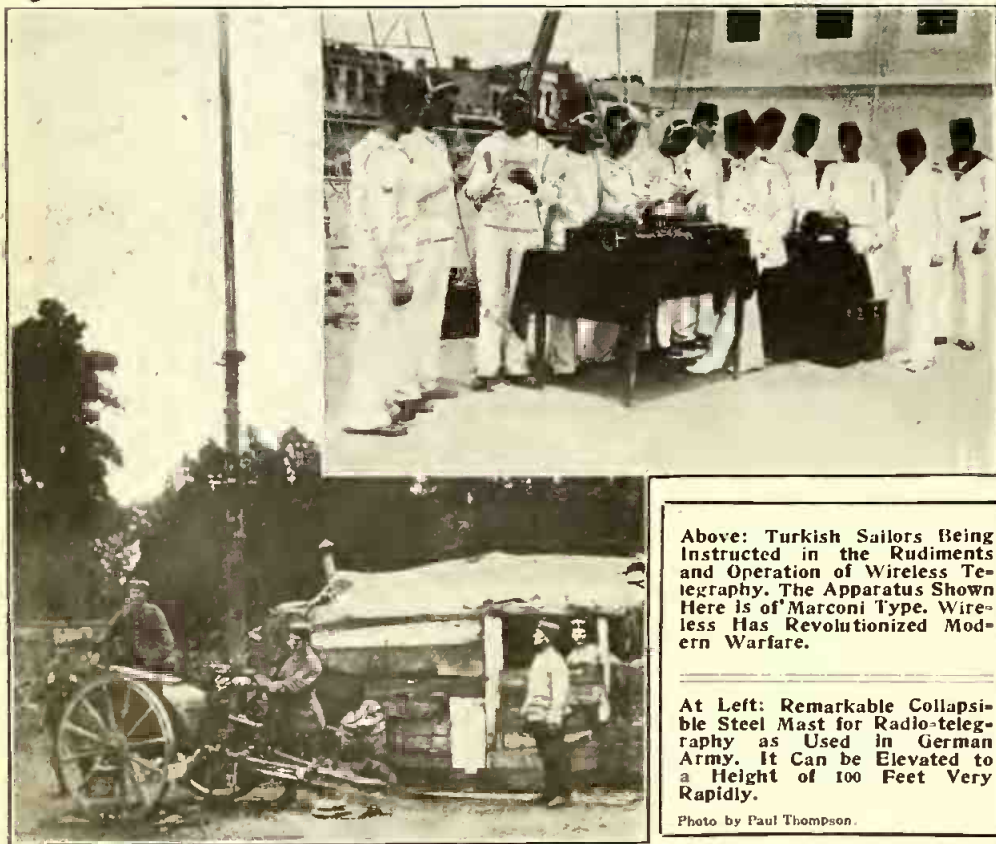

Above: Turkish Sailors Being Instructed in the Rudiments and Operation of Wireless Telegraphy. The Apparatus Shown Here is of Marconi Type. Wireless Has Revolutionized Modern Warfare.

At Left: Remarkable Collapsible Steel Mast for Radio-telegraphy as Used in German Army. It Can be Elevated to a Height of 100 Feet Very Rapidly.

Photo by Paul Thompson.

coni radio set as used in teaching the Turkish sailors the rudiments of the art. The outfit as perceived includes a multiple valve tuner of the latest Marconi style, as well as a magnetic detector. The transmitter comprises a 10-inch spark coil, together with storage batteries and other auxiliary apparatus. Regular wireless messages are being received by the students here shown. The Turks have made good use of wireless telegraphy in their numerous brilliant maneuvers on land and sea.

picted. Suitable guy wires are provided for strengthening the mast as it is projected upward, and the total work of raising same to its maximum height, ready for the purpose of transmitting and receiving messages over a fairly large range, can be accomplished in a few minutes by the well trained German radio corps. The wireless apparatus is contained in another cart not shown in the picture. The whole equipment forms a very compact and easily portable outfit.

VINELAND HIGH SCHOOL RADIO ASSOCIATION.

The Vineland High School Radio Association, of Vineland, N. J., was recently organized. Leslie H. Adams was elected president; Firman A. DeMaris, vice-president; Franklin Lamb, secretary, and Frank M. Comfort, treasurer and advisory president.

The association has secured permanent rooms, through the kindness of the Board of Education, in the physical laboratory of the new Vocational High School.

The aerial will have an average height of 100 feet and a length of 250 feet. The set will consist of a 1/2-k.w. transmitting set and a receiving set of standard make.

The object of the association is to bring the amateurs of Vineland and vicinity in closer relation and to purchase elaborate equipment which would be impossible otherwise.

The association would like to get into communication with other clubs. All correspondence should be sent to Franklin Lamb, 623 Elmer street, Vineland, N. J.

THE MOST LONESOME RADIO STATION.

On Swan Island, in the Caribbean Sea, is situated what is probably the most iso-

lated wireless station in the world. The station crew is made up of three operators, two engineers, a cook, a machinist and three laborers. No women are permitted to land on the island. Men who express a willingness to go to Swan Island are obliged to sign a contract whereby they agree to remain at least 18 months or waive their right to free return transportation. Those remaining the full period of service are returned to their homes by way of one of the Central American ports and are granted six weeks' vacation with full pay.

Strangely enough, there is no difficulty in obtaining men to man the station. Applicants, indeed, exceed the number of vacancies. Board and lodging, of course, are supplied, a boat bearing all provisions necessary, including fresh meat, and the mail as well, arriving regularly every two weeks. Some men have remained on the island as long as two years and a half and, subsequently, have been glad to return to the station.

305 FOOT RADIO MAST BLOWN DOWN.

On September 26 last the 305-foot steel wireless tower of the American Radio and Research Corporation was blown down at Tufts College, Mass. Through carelessness in erection details the tower fell, it is

claimed. The accident was the result of insufficient temporary guying. It had been erected to its full height, but was not entirely completed. It was made up of structural steel with a cross-section of 3 feet 4 inches square, and followed the same dimensions all the way up; the total height was 305 feet. The plans called for three sets of guy ropes at intervals of 100 feet of height. The two lower sets of guys were permanently in place, but some 5-16-inch steel rope was fastened temporarily to the top. As the design called for 3/4-inch crucible steel guys for the top, it is evident that the guys used temporarily had an ultimate strength of only 1-12th that called for by the plans. The high wind of September 26 last parted the temporary 5-16-inch steel rope, allowing the top of the tower to sway out, thus bringing into play enormously high stresses at the next lower set of guys. This undue strain snapped first the middle set of guys and then the lower ones.

Some interesting features were noted in the falling of this tower. There were no signs of buckling, the tower falling as a unit indicating great rigidity. It fell across a street railway line, cutting down the trolley wires and feeder cables across the tracks of the Boston & Maine Railway, derailing a locomotive. When the locomotive fender caught the end of the mast it dragged the tower 50 feet down the tracks, twisting the steel somewhat. It was remarkable, however, the way the steel held together, shearing off the bolts rather than pulling out the bolt holes.

The tower was insulated from the ground. Some of the base insulators remained intact, although a few were crushed, due to the side thrust of the falling mast.

The rebuilding of the tower was started immediately. After the new insulators were in place and the cement hardened the steel work was started anew. It is now up 60 feet and should be completed within



Two Views of Fallen 305-foot Steel Radio Tower at Tufts College, Mass.

a short time. All the anchor blocks were perfect, showing no trace of the strain exerted when the tower fell.

Never dust electric globes while unlighted. The static electricity generated will break the filaments.

POWERFUL SEARCHLIGHTS WORK WONDERS IN MODERN WARFARE.

In modern warfare some of the greatest battles are not fought in the daytime, but at night, when darkness provides a mighty impenetrable blanket over land and sea. For that reason the enormous armies now engaged in the titanic struggle in Europe invoke the use of powerful electric searchlights which blaze forth over the battleground at night, so that advances and sorties may be made regardless of nature's handicap. Our illustrations show a clever method for handling, to the best advantage, a powerful electric searchlight projector and, moreover, its mounting is cleverly placed on a specially constructed wagon, as perceived. This vehicle carries at the rear two large reels of flexible cable, which serve to supply the arc lamp with current from a petrol engine and dynamo plant similarly mounted on a wagon, but located in most cases at some distance from the projector.

When the searchlight wagon has reached the point where it is to be used on the field the telescopic, collapsible framework here shown is elevated in a few seconds to any desired height and the searchlight can now be swung to whatever direction desired. A flexible electric cable leads down from the projector case to make connection with the wires leading back to the dynamo truck, as aforementioned.

This outfit is also equipped with a military type telephone instrument, whose circuit runs back to the rear army guard. Note how the truck is partially covered with pine boughs in an effort to conceal the outfit as much as possible from the reconnoitering aeroplanes of the enemy during daytime. Some of these schemes are carried out in such detail that the apparatus cannot be observed at all, even when the scouting aeroplane flies but a short distance above the earth. The particular searchlight here shown has done effective duty in Northern France, and, as may be

judged from the pictures, this unit forms a part of the wonderful German signal corps equipment, which is said on good authority, to be second to none in the world to-day. It must be remembered that in most instances, not one or two searchlights are used on the battlefield, but whole

sums from 5 to 15 kilowatts. Some searchlights require less, where they are used for minor work, and likewise some of them take more energy than above mentioned. The American Army and Navy are equipped with some of the largest projectors extant, several of which measure 60 inches



Above: German Signal Corps About to Put into Operation One of Their Powerful 36-inch Electric Searchlight Projectors for Night Fighting. Left: Supporting Frame Elevated. Note Screen of Trees to Help Disguise It From Enemy During Day.

Photos Copyright by Underwood & Underwood.

batteries of them are brought into play simultaneously, so that the ground is brilliantly illuminated for several miles, thus for all practical purposes they take the place of the sun itself. Occasionally one of these powerful searchlight beams spots an enemy's aeroplane at night, and in several instances it has resulted in the flying scout being brought to earth in short order by the effective use of anti-aircraft guns.

The majority of these devices operate on 80 to 110 volts, direct current, and con-

and more in diameter across the reflector. The front opening of the lamp cases are closed with glass, but this is not in one piece. It is divided up into several narrow strips to permit greater facility in replacement, and also to more efficiently take care of the unequal expansion and contraction of the glass, due to the enormous amount of heat developed by the arc, and which is moreover reflected against the glass by the parabolic mirror in the rear of the lamp housing.

HOW THE WIRELESS "WIZ" CELEBRATED XMAS.
(Continued from page 390.)

"Well, see you later in the day," I sang out. * * *

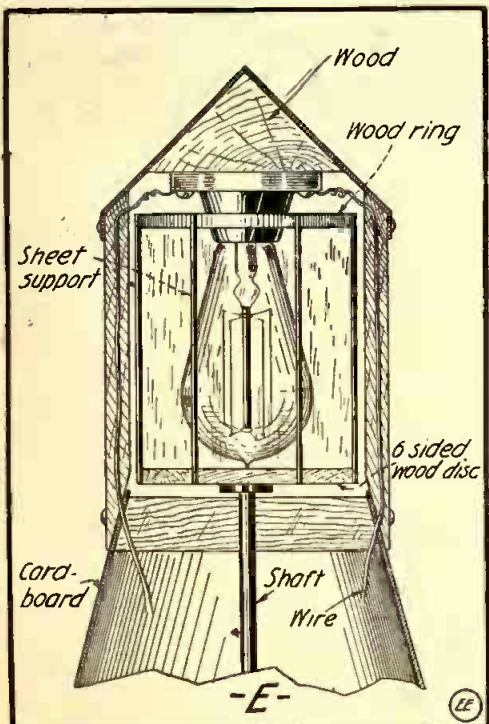

Fig. E. How Revolving Flasher of Searchlight is Constructed.

"Are you ready for the dope now?" inquired the "Wiz" that night at 11, as he sank into the chair at his desk and drew forth a few sheets of blank paper, on which he proceeded to make some sketches. "Well, I'll now 'wise you up' on the railroad stunt first. I was certainly stuck for a while on the switches for this system, till I got into communication with a New York electrical firm and managed to get hold of a complete list of miniature railroad supplies to fill my bill. I used two stations—'A' and 'B' (see sketch A)—and one siding made of standard track.

The three switches were electrically operated from the switchboard and were made similar to this sketch B. Two magnets were mounted with a pivoted magnetized arm to play between them. This pivoted arm was fastened to the bar that swung the switch, and by throwing the current in one direction or the other I was able to open or close the switch.

"The third rail on the side-track and stations was disconnected from the main system, and I had switches 1, 2 and 3 arranged to control them, while switch 4 controlled the current to the main track. The electric switches 5, 6, 7, 8, 9 and 10 controlled the operation of the track switches. I also rigged up magnetically controlled reversing stops at several points, marked X, controlled by keys 11, 12, 13, 14, 15 and 16. These reversers also operate the semaphores by means of the sliding rod, 'R,' pushing the arm into 'Danger' position.

"Now the operation of the system can be briefly outlined as follows: Making the freight train's station, 'A,' and the express

train's station, 'B'; then, by closing the switch 1, the freight train is started out on the main track and runs in the direction indicated by the arrow. When it has just passed the express station we may throw the current into that track by closing the switch 2, and the express train will

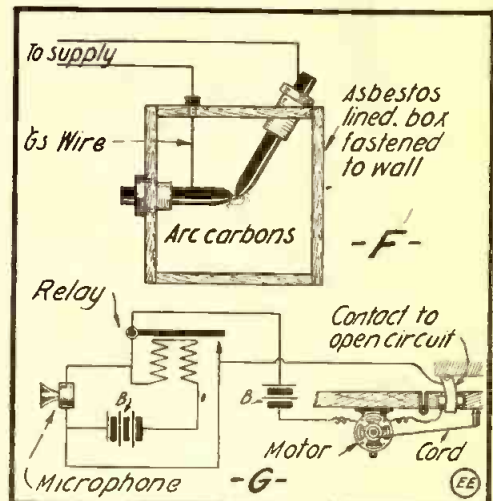

Figs. F. and G. Details of Electric Arc and Microphone Control Relay Used to Open Door.

start out in the opposite direction. It will look just like a head-on collision, but by depressing the key 9 the switch is opened that allows the freight train to run onto the side-track; and the button 11, controlling the reverse, is pressed at the same time and the reverse gear will cause it to
(Continued on page 451.)

The United States Advisory Board and Its Personnel

THE newly-appointed United States Naval Advisory Board of scientists, inventors and engineers, which is the outcome of an excellent idea originated by the Secretary of our Navy, Josephus Daniels, recently held its first meeting and several important matters were taken up at that session. A consulting staff of specialists, such as here brought together, should have been available for the benefit of our Government many years ago, and it is really remarkable that such an idea was not formulated and carried through long before now.

The photograph herewith shows the members of the Advisory Board at their first meeting in Washington, D. C., and below is given a brief outline of the qualifications of the savants and engineers who make up this staff, which is headed by Thomas Alva Edison as Chairman of the Board.

Mr. Edison is probably one of the most

present wonderful success as a captain of industry and invention. It would be hard indeed to find a man with a more general and widely extended education than Mr. Edison and, as we know, he has been responsible for many of our greatest mechanical and electrical devices of untold benefit to the human race, such as the electric light, phonograph, motion picture machine and storage batteries, etc. In all, this phenomenal man has taken out over 1,200 patents on various inventions.

Two well-known mathematicians were nominated to the Board by the American Mathematical Society. These were Professor Robert Simpson Woodward, of Washington, D. C. and Professor Arthur Gordon Webster, of Worcester, Mass. The former gentleman is a well-known engineer and an expert in astronomical matters. He was born in Rochester, Mich., in 1849 and graduated with the degrees of Civil Engineer

considered an authority on physics.

The two members nominated by the American Society of Civil Engineers were Alfred Craven and Andrew Murray Hunt. The former gentleman has been for many years connected with the various branches of the municipal engineering department of New York City. He is a son of Rear Admiral Thomas C. Craven and a nephew of Alfred W. Craven, for many years Chief Engineer of the old Croton Aqueduct. He was born in Bound Brook, N. J., in 1846 and graduated from the United States Naval Academy. In 1910 he became Chief Engineer of the Rapid Transit Commission of New York. His experiences have been varied and most thorough, and his opinion on engineering and technical matters is taken as final. Mr. Hunt comes from San Francisco and occupies a prominent position as an engineer in that city. He also graduated from the United States Naval Academy in



Photo Copyright by International Film Service.

In the above illustration looking from left to right, the following members of the new Naval Advisory Board appear as indicated: 1. Josephus Daniels, Secretary of the Navy; 2. Thomas A. Edison, Chairman of the Board; 3. Elmer Ambrose Sperry; 4. Arthur Gordon Webster; 5. Hudson Maxim; 6. Lawrence Saunders; 7. Benjamin G. Lamme; 8. Frank Julian Sprague; 9. Henry Alexander Wise Wood; 10. Lawrence Addicks; 11. Howard E. Coffin; 12. Spencer Miller; 13. Thomas Robins; 14. Wm. L. Emmett; 15. L. H. Baekeland; 16. Benj. B. Thayer; 17. W. R. Whitney; 18. Peter Cooper Hewitt; 19. Joseph W. Richards; 20. Alfred Craven; 21. Andrew Murray Hunt; 22. Andrew L. Riker; 23. Robert Simpson Woodward; 24. Matthew B. Sellers.

widely read and experienced scientific men available in this country to-day, and so we may indeed congratulate ourselves in having such an able electrician and inventor at the head of this illustrious body of well-trained specialists which, in its entirety, covers practically all branches of applied science with which we are familiar to-day—from navigation to wireless.

Thomas Alva Edison was born in 1847 in Milan, O. His early education was entirely self-acquired, and he very early took up the vocation of a railroad telegraph operator. However, his leaning toward scientific and technical matters caused him to invent at an early age an attachment for telegraphic apparatus. He finally disposed of one of his inventions at a goodly sum, which really started him on the road to his

and Doctor of Philosophy. He has also received honorary degrees from the Universities of Wisconsin, Columbia and Pennsylvania. Part of his experiences covered positions as assistant engineer in the United States Lake Survey, assistant astronomer in the United States Transit of Venus Commission, etc. He was at one time Professor of Mechanics, Physics and Mathematics at Columbia University and also served in the capacity of president of Carnegie Institution and has besides served in various capacities in numerous scientific societies. Professor Webster is Professor of Physics at Clark University, Worcester. He was born at Brookline, Mass., in 1863 and graduated from Harvard University. He has spent much time abroad at scientific schools in Berlin, Paris and Stockholm, and is con-

1879. He is a specialist in steam and gas engine plant design, as well as hydro-electric developments of large extent.

The Inventors' Guild selected two members for the Board, namely, Peter Cooper Hewitt, of New York, and Thomas Robins. Mr. Hewitt is a New Yorker born and bred, and first saw the light of day in 1861. He graduated from Stevens Institute with the degrees of mechanical and electrical engineer. He was also honored with a degree of Doctor of Science from Columbia University. He has performed very extensive research work in the direction of mercury vapor and mercury arc devices, such as rectifiers, illuminating devices, etc., and latterly has taken up the work of developing special generating and amplifying mercury vapor apparatus for use in radio-teleg-

ETHEREAL ELASTICITY.

The Danish physicist Oersted, in 1819, discovered the magnetic effect of electric currents upon needles. It created a great deal of excitement at the time because it was the first clew which had been found that a relationship existed between electricity and magnetism. The idea that a third electricity existed was never advanced until my "Electrical Theory of the Universe" was published, says Prof. G. W. Cooper, suggesting that an electron of electricity was composed of positive, negative and magnetic electricity, magnetic occupying the center of an oblong electron. The ether of space has been referred to by many scientists as the elasticity that holds our earth to the sun, or bodies of the universe in their respective places, but no scientist has ever attempted to explain what that elasticity is. If we accept the theory of three kinds of electricity and allow each electron in nature to set universally north and south, unless otherwise deflected, and that like electrically repels and unlike attracts (meaning positive and negative electricity); also that magnetic electricity attracts positive, negative and magnetic. The drawing will illustrate this arrangement of electrons, showing lines of attraction and repulsion. If we pull the electrons apart endwise and let go they will instantly fly back to place; if we pull them apart or push them together sidewise and let go they will return to their former position.

If we accept this theory we have the only explanation of the elasticity of the

ether of space, and if the earth was pulled out a million miles farther into space and released, it would go back into position so gently that we would never know it happened. Now, if we change Newton's famous law of gravitation and use electrons instead of bodies, here is the result: Any two masses of electrons (meaning any magnets) in the universe attract each other

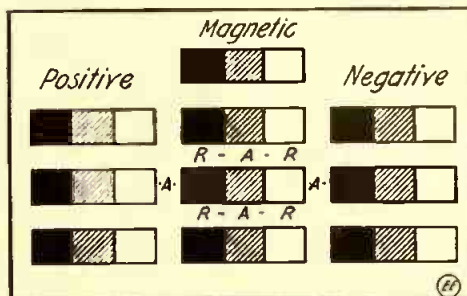

Diagram Showing Arrangement of Positive, Negative and Magnetic Electrons. Attraction at A; Repulsion at R.

with a force which is directly proportionate to the product of the masses and inversely proportional to the square of the distance between them; also, every electron in the universe attracts every other electron with a force which varies inversely as the square of the distance between the two electrons.

HUMANE USES OF WIRELESS PHONE.

Since the recent wonderful achievement

raphy and telephony. Thomas Robins is a resident of Stamford, Conn. He was born at West Point, N. Y., in 1868 and graduated from Princeton University. He is in business in his home city, holding the position of president of the Robins Belt Conveyor Co. He also serves as secretary of the Inventors' Guild and is a member of a number of technical societies.

The American Society of Automobile Engineers is represented by Andrew L. Riker and Howard E. Coffin, both of Detroit. The former was born in New York City in 1868 and is a graduate of the Columbia Law School. He later became greatly interested in the problem of mechanical propulsion of vehicles. One of his early inventions was that of the first electrically propelled vehicle in this country. His experience with gasoline engines and vehicles adapted to propulsion by this means has been vast and varied. Probably one of the best-known men in the automobile line is Howard E. Coffin. He was born at West Milton, O., in 1873 and studied at the University of Michigan, where he received the degrees of B.S. and M.E. He was for several years in the United States Civil Service, along the line of internal combustion engineering and was for some time in charge of the Olds Motor Works' experimental department, at which plant he later served as chief engineer. Since 1910 he has held the office of vice-president and consulting engineer of the Hudson Motor Car Co.

From the flying world two well-known inventors were selected through the courtesy of the American Society of Aeronautic Engineers. These representatives are Henry A. Wise Wood and Elmer A. Sperry. Mr. Wood hails from New York. He has perfected and developed many appliances in the realm of printing machinery and for which he was awarded a gold medal by the Franklin Institute. Among his societies is the Society of Naval Architects and Marine Engineers. For some time he has been an enthusiastic student of, and a writer on, aeronautical subjects. He was born in New York City in 1865 and received his early education in the Media Academy at Media,

Pa. The latter gentleman—Mr. Sperry—is well known to-day for his inventions pertaining to the automatic stabilizing of aeroplanes. He also is an electrical engineer of ability, besides having had wide experience in many other lines of engineering and industry. He was born at Cortland, N. Y., in 1860 and received his degree from Cornell University. He is a member of many scientific and technical societies and should prove indeed a very able and valuable member of the Naval Advisory Board.

From the American Society of Mechanical Engineers there were nominated William LeRoy Emmett, of Schenectady, and Spencer Miller, of South Orange, N. J. Mr. Emmett was born at Pelham, N. Y., in 1859 and graduated from the United States Naval Academy and has also received the honorary degree of Doctor of Science from Union College. He has specialized in electrical engineering. At present he is connected with the illuminating engineering department of the General Electric Co. Mr. Miller serves as chief engineer in the cableway department of the Lidgerwood Manufacturing Co. He was born in Waukegon, Ill., and graduated from Worcester Polytechnic with the degree of B.S. He has made a number of inventions relating to apparatus for saving life at sea and cableways for coaling vessels at sea, which devices are used by the Navy Department of the United States Government.

In electrical science two brilliant men were selected by the American Institute of Electrical Engineers; namely, Frank Julian Sprague, of New York City, and Benjamin G. Lamme, of Pittsburgh, Pa. As a pioneer in the development of electric railways and devices for the control and operation of same, Mr. Sprague is well known and he has served in many important capacities with various corporations. He was born in Milford, Conn., in 1857 and graduated from the United States Naval Academy. He was at one time assistant to Thomas A. Edison and has acted as consulting engineer to the Edison General Electric Co., the General Electric Co., and as a member of the Terminal Commission for the Electrification of

of successful wireless telephony from the Atlantic coast to Honolulu suggestions are forthcoming of possible life-saving uses at sea for this latest scientific miracle. If the device had been perfected a few years earlier the Titanic disaster might have been averted, for President Vail, of the American Telephone & Telegraph Co., predicts the employment of the apparatus as a protection to liners against icebergs. The idea is to equip a lifeboat with a wireless telephone, and when a ship gets into a fog where ice may be met, to send the boat ahead as a scout to give warning of danger. This use would also guard against collisions between vessels in fog, which have cost so many thousands of lives in maritime history.

Again, when a man has fallen overboard, it often happens that rescuers sent out in a small boat cannot see him, although he may be plainly visible from the ship's crow's nest. It is pointed out that the lookout could direct the rescue if the lifeboat were fitted with a wireless telephone. Then, too, there would be the value of wireless telephony to castaways from shipwrecks. Communication between their boats and passing ships would be comparatively easy. The wireless "telephone" has an immense advantage over the wireless "telegraph" in that it does not call for the presence of a skilled operator, and the mechanism is much simpler. Thus the newest marvel of modern science bids fair to rob sea travel of much of its danger and suffering.

the New York Central Railway. Mr. Lamme was born on a farm near Springfield, O., and graduated as a mechanical engineer from the Ohio State University. He has had a large amount of designing and other experience with the Westinghouse Electric Manufacturing Co. at Pittsburgh, and at present holds the position of chief engineer with that corporation. He is one of the best-known men to-day in the field of large size alternating current electrical machinery design, and the mighty generators at the Niagara Falls power plant are constructed after his designs. He holds many patents on electrical machinery. One of his particular pleasures is in discovering and assisting young men of ability along the lines of his chosen profession.

In the field of aeronautics two well-known men have been appointed by the Aeronautical Society of America in the persons of Hudson Maxim, of Brooklyn, N. Y., and Howard Bacon Sellers, of Baltimore, Md. The former is well known throughout the world for his original and important research work on high explosives and his activities have covered many other fields of sociology, philosophy and science. He was born in Orneville, Me., and at an early age he engaged in the publishing business. Later he took up the work of inventor and experimenter, developing the first smokeless powder ever used by the United States Government. This invention he later disposed of to the Du Pont de Nemours Powder Co., of which he became the consulting engineer and expert in research work. In later years he has evinced great interest in aeronautical science and has made many valuable suggestions along this direction. Mr. Sellers was born in Baltimore and there he received his early education. He studied in the Law School of Harvard University, from which he later graduated, and then followed up this work with courses in the Laurence Scientific School and the Drexel Institute in Philadelphia. He was the first editor of *Aeronautics* and is also a member and past chairman of the technical board of the Aero
(Continued on page 450.)

The Electrical Burglar of the 20th Century

It is, indeed, surprising what ingenuity and ability are shown among the criminal classes in quickly adapting the latest advances in the electrical and mechanical

side of the building or also within same. In this case the supersensitive microphone transmitter of the detectaphone is placed outside the front door of the building or

and one is here shown illuminating the combination lock dial of the safe.

A cable is perceived dropping down from a convenient electrolier and terminating in a large disc fitted with a carbon electrode and insulated handle, which lies in front of the burglar who is attempting to open the safe. A pair of smoked goggles are necessary in conjunction with the use of this electric arc burning apparatus. Whenever the safe lock refuses to yield to the treatment aforementioned, it is a matter of but a few moments, relatively speaking, to ground one side of the electric circuit to the safe and by means of the shielded electrode just mentioned, an arc is readily established between it and the surface of the safe door. This "arc" is one of the hottest fusing agencies known to modern science. It has a temperature of from 6,000 to 7,000 degrees Fahrenheit, and it is needless to say that the hardest nickel steel, even though Harveyized or chilled, will soon be melted by the intense heat of the incandescent electric arc gaseous stream thus produced. As may be readily imagined, it would take but a short time to literally "bite" the lock mechanism right out of the safe door. When this work has been performed it is a simple matter to throw the bolts and open the door in most cases.

However, in this instance as well as in most others, and in accordance with the old proverb, "There never was a smart man but that there was a smarter one," it is safe to say that sooner or later the most clever and cunning tricks of the best yeggmen are ferreted out or compensated for by equally clever counteracting ideas as promulgated and devised by our modern detective and police experts. The selenium cell is probably one of the best devices with which to foil the would-be safe-breaker, for the minute he flashes a light on the spot where the selenium cell is concealed, an electric bell will ring in any part of the building desired or at police headquarters, notifying the proper parties instantly as to where the alarm originated. Thus it is that the march of science is constantly toward a higher plane, endeavoring to eliminate any weak spots in diversified applications to the needs of society and the fine arts.



The Modern Burglar Utilizes Electricity to Find the Combination of a Safe and for Numerous Other Purposes.

sciences to their art—if we may so call it—of breaking into safes, vaults and buildings. The up-to-date burglar has many marvelous scientific devices at his beck and call, and most of them require but little knowledge of science or the trades in order to operate them very effectively.

Our illustration herewith depicts a 20th century burglar in the act of blindly checking up the combination lock on a steel safe by means of a very sensitive telephone outfit, known as a "Detectaphone." The microphone transmitter of this supersensitive telephone set is held, by means of a rubber suction cup, against the front of the safe door in proximity to the combination lock mechanism. When the knob carrying the numbered dial of such a lock is rotated, the movement of the bolts on the inside of the door can be heard, and in some cases the interlocking of the various parts of the lock mechanism proper can be perceived by this arrangement. It thus becomes an easy matter for a clever safe-breaker, with a little patience, to readily open any ordinary safe or vault door fitted with this type of lock, without knowing the actual combination numbers by which it was locked in the first place. The telephone set is completed by a pair of sensitive telephone receivers placed over the ears as our illustration indicates, and the battery for this set may be carried in the pocket as depicted at B.

down the length of the hall, as the case may necessitate.

While on the subject it may be of interest to state that the yeggmen and second-story "artists" of our day use nothing but electric flashlights or battery lamps,

SEEING A BASEBALL GAME BY WIRE.

One of the most novel and entertaining

photograph which depicts an exact reproduction of a baseball field, but on a miniature scale. The action of the complete de-

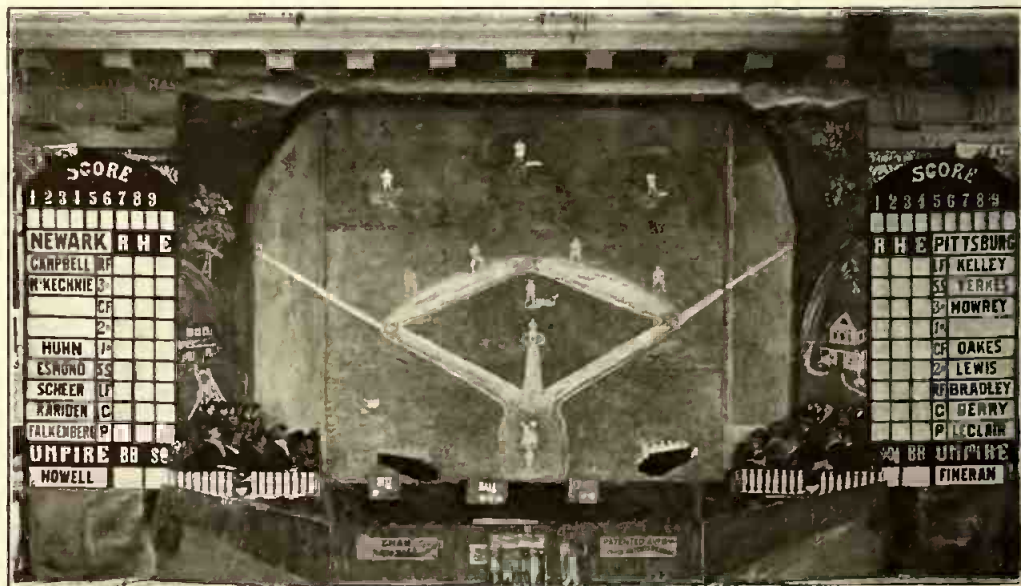

This Electrically Operated Baseball Diamond in Miniature Duplicates Every "Play" Made.

inventions of the 20th century is that enabling one to see a baseball game by wire. This is illustrated in the accompanying

vice is very human; that is to say, each performance of the player is so naturally (Continued on page 454.)

ELECTRICAL PROSPERITY WEEK.

By John A. Randolph.

(The Society for Electrical Development.)

OPTIMISM, enduring, persevering, finally triumphant, made the biblical legend of "Job" a classic. Job looked on the sunny side, kept plugging, and achieved prosperity in the end. The moral is obvious.

With the same faith in destiny, hope for the future and confidence in truth, the united electrical interests of the country have planned a big sales campaign for the week of Nov. 29 to Dec. 4.

They have called it **ELECTRICAL PROSPERITY WEEK**, a fitting name, fraught with wholesomeness and characterized by the spirit electrical.

It is to be an event, a six-day celebration, in which the people throughout the United States from the Canadian frontier to the borders of Mexico, from ocean to ocean, will be shown the wonders of electricity as never before—will be taught how inseparably linked with modern progress this all pervading force has come to be. In short, the purpose is to advocate, demonstrate, promulgate, electricity.

The Goddess Electra.—The emblem of the celebration is a design beautifully symbolical of the broadness in scope, the cleanliness, convenience, economy of electricity. The central figure is the "Goddess Electra" in the act of closing an electric switch. A look of confidence and satisfaction illumines her countenance, as our illustration portrays. Electricity is her servant. The attractive background shows a residence section on one side and a city street on the other, with electric light and power everywhere. The home scene is peaceful. It suggests things as they ought to be—where drudgery has passed, to give way to cleanliness and purity, the light of truth.

The city street is suggestive, at once, of efficiency, system, speed—tasks done automatically, everything moving at the push of a button.

The design was as carefully chosen as the other features of the campaign. It was selected only after weeks of careful consideration, during which a large number of other designs produced by many of the



Official Design for Electrical Prosperity Week.

foremost artists of the country, were submitted for approval.

The story of the choosing of the model for the "goddess" was published in the newspapers throughout the country. She was chosen by contest, the final selection being made by a jury of well-known artists.

UP-TO-DATE SHOPPING

BY TELEPHONE.

Newark, N. J., has a new shopping idea. Usually there are two ways of shopping—either by telephone or going personally into the store. This shopper goes to the window of the store, which in this case is the Western Electric Co.'s supply depot at 61 Park place, picks up one of the several Inter-

tomers coming inside at all. An increase in sales has resulted.

Here's the way the new electrical seller is worked out: A desk equipped with order books, Inter-phones and electrical devices has been placed just inside the show window. One of the office force sits at the desk in plain view of the passing thousands. He is a very busy young man. His desk 'phones are connected up to lines which reach to the outside. A customer comes



Electrical Supply Store Uses Telephone Outside of Show Window to Attract Customers.

phones extending through to the street side of the window, and talks to the clerk inside, as perceived from the photo.

Experts in selling goods to the public often say that if a dealer can only get people inside his store he will sell goods. That's why so many bargain days are conducted. People come for the bargains, but also buy other goods. Just to try out the psychology of this claim the local manager of this store decided to find a way to sell goods and take orders without his cus-

tomers, sees some electrical appliance that he needs, picks up the outside Inter-phone, speaks quickly to the clerk in the window, who is there to take down orders, and asks the clerk for further details about cost, etc., of devices in the window. Usually a crowd stands about waiting for a chance to ask questions. Addresses are obtained and the mailing list improved by the arrangement, besides giving to the public an excellent idea of how an up-to-date concern handles its office work.

The winner was Miss Florence Cassasa, of Brooklyn.

The spirit of the celebration will be education. The public will be shown as never before that electricity is a necessity, not a luxury; is economical, not expensive; is simple, not complex; is broad in scope, not limited; is safe, not dangerous; is, in short, the most willing, reliable, able servant mankind has ever known.

Displays, exhibitions, lectures, parades, shows will be held everywhere—presenting, demonstrating, explaining things electrical as never before. A blaze of illumination from coast to coast will come at night as a climax to the activities of the day. Myriads of electric lamps of all types, shapes and sizes will take up the light where the sun leaves off. The coolness of the year will make people actively receptive. Meetings in full sway everywhere will offer unbounded facilities for lectures.

The schools will be in session, and will provide a means of setting forth the advantages of electricity to the coming generations by prize essay contests upon electrical subjects. "Electurettes," recitations,

readings, addresses embodying the electrical spirit.

ELECTRIC SHOWER FOR A BRIDE TO BE.

It is the custom among young people to give a "shower" to a bride to be and bestow upon her gifts that she is likely to need in her future home. There are linen showers and handkerchief showers, tinware and woodenware showers, but the very latest is the "electric" shower!

Miss Irene Brothers, of Nela Park, Cleveland, was the fortunate recipient of such a shower recently when her engagement was announced. The event took place in a beautiful ravine in Nela Park. Electric Japanese lanterns were strung among the trees. An electrically cooked supper was served. Among the electrical devices presented to Miss Brothers were an electric coffee percolator, toaster, grill, electric iron, hair drier, tea urn and table lamp, all of which can be utilized to best advantage in the modern home.

Man to man—can you afford to miss a single issue of this magazine?

SUBWAY IMPROVEMENTS CAUSE GREAT CHANGE IN ELECTRIC WIRES.

Owing to the vast amount of underground excavations now having to be made in New York City in building the new subway lines, which extend for many miles, the electrical engineers of the telephone and power companies have had their hands full in taking care of the continual shifting and rearrangement of the hun-

electric power and other cables. It is astonishing to the uninitiated who, for the first time, happens to behold one of these exposed sections of a New York thoroughfare, when he observes the tremendous amount of underground wires, cables and pipes which seem to intertwine and pass each other like so many huge snakes. The magnitude of this task becomes more apparent when it is considered that there are often a dozen different voltages, both high

their protective system work so that London could sleep in peace.

The detection system which Dr. de Forest proposes to work out is as follows: Several delicate microphones are placed on a geometrical figure, probably each on a mast. These microphones are equipped with Audions so that any vibration reaching them is magnified several hundred times, each of the Audions being of the same recording power. The microphone on that point of the geometrical figure nearest the approaching airship will record vibrations of a greater strength than the microphone on the most distant point of the figure. The effect of the vibrations upon the intermediary microphones will, of course, be of varying force, according to the relative distance of the microphone from the source of the vibrations, the approaching airship. From the varying effects of these vibrations on individual microphones is calculated the line of direction of the approach of the vibrations on each microphone. These lines of direction when extended form the outline of an imaginary cone, at the apex of which will be found the approaching airship.

When the location of the airship has been determined, Dr. de Forest's task ends, and that of the aeroplanes and airship guns begin. It is planned to send aeroplanes out above the dirigibles after the location has been determined.

GIRL RADIO OPERATORS.

No girls have as yet qualified as licensed radio operators in this country, although it is stated unofficially that hundreds of girls are transmitting messages in amateur stations controlled by their licensed brothers. Many French girls have qualified as wireless operators, and are now in active service in the war zone.

NOVEL ELECTRIC VIBRATOR

STRAPS ON HAND.

A very neat and efficient type of electric massage vibrator is shown in the illustration and, as perceived, it can be strapped to the back of the hand. The vibrations from the device may thus be transmitted through the hand to the face of the patient, etc. It is of great use to barbers and facial specialists. It is supplied for 110-volt direct-current or alternating-current circuits, and comes complete with flexible cord and attachment plug, which may be inserted in the regular lamp socket. Undoubtedly this is one of



Showing Vast Net Work of Electric Gas, Water and Steam Conductors in a New York City Street Exposed During Building of New Subway.

dreds of underground cables and wires used for telephone, light and power service.

The illustration we present herewith shows a section of Dey street where it intersects with Church street, in New York City. In the foreground may be seen one of the telephone cable manholes, in the process of reconstruction. At the left of the picture may be observed a myriad of

and low, being carried by these various cables and wires, and, also, the pipe lines which pass and re-pass these electric lines contain gas, live steam and water. Besides this, there are the huge sewer lines. All of these various transmission cables and conduits have to be invariably rearranged and shifted about in the construction of the subway, even to different levels, or from one side of the street to the other.

DR. DE FOREST TO HELP DETECT ZEPPELINS.

A middle-aged American inventor with an electric bulb arrived in London recently on a hurry-up call from the British Government to show Sir Percy Scott how the British capital may avert danger from Zeppelins. And when the American inventor has done his work in London he will cross the Channel to devise a system of protection from air attack for the treasures and the lives of Paris. The inventor is Dr. Lee de Forest, of New York City.

As our readers are well aware, Dr. de Forest is the inventor of the Audion amplifier, an adaptation of the incandescent electric light, by which feeble electric impulses can be magnified to a point at which they can be registered with considerable force.

For several months England has used for coast defense a system of microphone detection against submarines by means of which the vibration of the propellers of German submarines was picked up by microphones at sea and transmitted to a base, so that the approaching submarine could be located. This defense has been credited by London with being responsible for the destruction of many submarines.

In this plan an instrument fashioned on the principle of the Audion was used to magnify the impulses recorded by the microphones at sea, but that form of Audion was not perfected to the stage of Dr. de Forest's recent inventions.

The effectiveness of the coast defense system suggested to the English authorities a similar plan for defense against invading airships. But conditions were different from that of dealing with submarines, because microphones could not be placed high enough in the air to record the vibrations of the propellers of approaching Zeppelins. The success of the de Forest Audion was brought to the attention of the British authorities, and they sent for the man who had invented it to come over and make

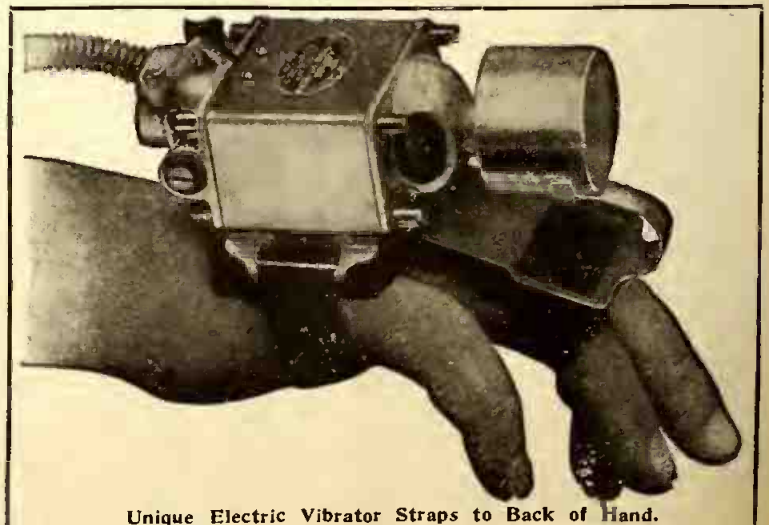

Unique Electric Vibrator Straps to Back of Hand.

the smallest practical massage vibrators of the electric type ever devised and one that will appeal to everyone interested in any way in this art.

A REMARKABLE ELECTRIC PIANO PLAYER FOR THE "MOVIES."

By Frank C. Perkins.

The accompanying illustration shows the mechanism of a wonderful electric piano player, controlled from the film booth by a series of buttons. By the use of sets of endless perforated rolls the movie operator is enabled to instantly change the type and



New Electric Piano Player, Designed to Replace Orchestras and Capable of Accurate Control by "Movie" Operator.

tempo of music from the rear of the house without any other attention to the piano. Bellows are eliminated by a series of electrical contact points which actuate hammers that play on the keys.

This electric piano player makes possible the instantaneous change from one piece of music to another at any moment and is particularly adapted for playing pianos in moving picture theaters, eliminating the services of the pianist and the disadvantages and annoyances incident thereto.

It will be seen that the player is placed before the piano, the latter remaining in its usual position before the picture screen, and is controlled by the moving picture operator from his booth by means of a simple electrical controller. The musical program embraces crescendo and thunderous

music for battle scenes and the like, allegretto or fast, lively music of various character to correspond with animated scenes such as horse or automobile racing, moderato for social or dramatic scenes, diminuendo, or slow music to coincide with pathetic or sentimental pictures, Indian music to make American Indian action more realistic, staccato chords for highwaymen or burglar action, the music produced having automatic expression.

It is stated that in addition to the above musical effects the more expensive machines are equipped with elementary apparatus controlled by the picture operator for producing battle chaos, shooting, thunder, lightning and wind. Instantaneous changes from one selection of music to another with change in tempo, at the instant the scenes are shifted on the screen, is a most important factor for the successful display of a film.

It is pointed out that in this the ordinary piano player is deficient and the effects desired are oftentimes spoiled. The common automatic piano is almost worse than useless for the picture theater on account of lack of music control, for it may play "Onward, Christian Soldiers" while burglars operate, tango music for a battle scene or a waltz for a funeral.

It is, of course, apparent that the right music at the right time and in the right time, is most vital for the success of the motion picture house; for without it the proper effect of the pictures is nullified which means eventually the loss of patronage.

It is held that with the new player installed to operate the piano, the musical program is directly under the control of the picture operator as it should be and at his will the music changes *instantaneously* on pushing a button, even to the breaking off of playing one selection at any note, and the beginning of another of different tempo the next second—so flexible is the electric current in connection with this mechanism. It is thus possible at all times to have melody to correspond and be consistent with each picture shown.

Not only baseball scores, but the latest word about the Kaiser and the war and William Jennings Bryan's latest opinion penetrate the tropical evenings. The officers and men of Uncle Sam's warships in West Indian waters are now able to learn of the things going on at home and abroad.

Every night the day's news is boiled down to 200 words—just as it should be, someone says—and is telegraphed to the naval wireless station at Key West, Fla. Then the wireless sparks begin to sputter and out over the Gulf, the Caribbean and the South Atlantic flashes the news "from home."

Capt. W. H. Bullard, Superintendent of the Naval Radio Service, is the man who

conceived the idea, and through his suggestion Secretary Daniels obtained the co-operation of the news agency and the telegraph company. Only officers and sailors who are thousands of miles from home, in strange waters, by strange shores, can fully appreciate the value of a service of this kind.

Not long ago some 300 jewelers informed Secretary Daniels that they had equipped themselves with radio apparatus just to catch this twice daily time flash from Washington. Time signals are said to be of immense benefit to vessels on the high seas, which now possess for the first time an accurate means of checking their chronometers, which is of the greatest help in fixing longitude.

As soon as the new wireless section in the Philippines is completed it is believed that an interchange of messages between the Philippines and the United States can be made in 30 minutes.

WOMAN MAKES TELEPHONIC INVENTION.

Knowing nothing of the workings of electricity or the telephone, but living daily with a paralyzed husband and mother, who in her absence could not lift the receiver to answer the 'phone, a Memphis, Tenn., woman has invented and patented an appliance to the telephone which enables one to talk and hear without using the hands at all.

The appliance is on the order of a phonograph horn and the connection is made by pushing a little button which is mounted on the stem of the 'phone. This can be done with a pencil held in the teeth if necessary, and the connection once open, the sound may easily be received and sent 15 feet away from the device by talking in a moderate tone of voice.

This combination 'phone will be especially desirable in hospitals or with invalids who have no use of their hands, as they may talk and hear with the greatest ease.

This appliance also enables one to cut out the branch 'phone in the house, as the instrument placed on the landing or stairway with string attached to button enables



Telephonic Loud Speaking Device Invented by a Woman.

one to answer calls and hear perfectly without going upstairs or down.

The newest patent for the "Hatch Combination 'Phone" is the collapsible horn and the sound intensifier; by the use of the former the 'phone has the appearance of an ordinary instrument, and by putting it over the lips and using the intensifier properly one may carry on conversation as privately as if he were in a sound-proof booth.

DAILY NEWS RADIO NOW GOES TO NAVY IN DISTANT WATERS.

Even the oldest inhabitant of Port-au-Prince, Hayti, cannot remember the time before now when the tropics received the baseball scores every evening.

Somehow one doesn't associate the thought of the blue Caribbean and scorching semi-equatorial sunshine with the thought of "New York, 4; Pittsburgh, 6." But it's an actual fact, just the same.

Secretary Daniels has been bitterly assailed as the man who took the Demon Rum out of the navy. But the officers and men in Southern waters bless his name as the man who gave them baseball scores every night.

Marvelous Electric Sign that Actually Spells

A RECENT innovation in the multitudinous array of electric signs appearing along the "Great White Way," otherwise known as Broadway, New York City, is that advertising "Pebeco" tooth paste. The illustrations herewith show four distinct views of this extremely

Complete sentences are spelled out in this way, but of course only a section of the sentence, as two or three words appear in the course of a couple of minutes, while the letters form at the right and move across the sign, so to speak.

To more clearly illustrate the action of

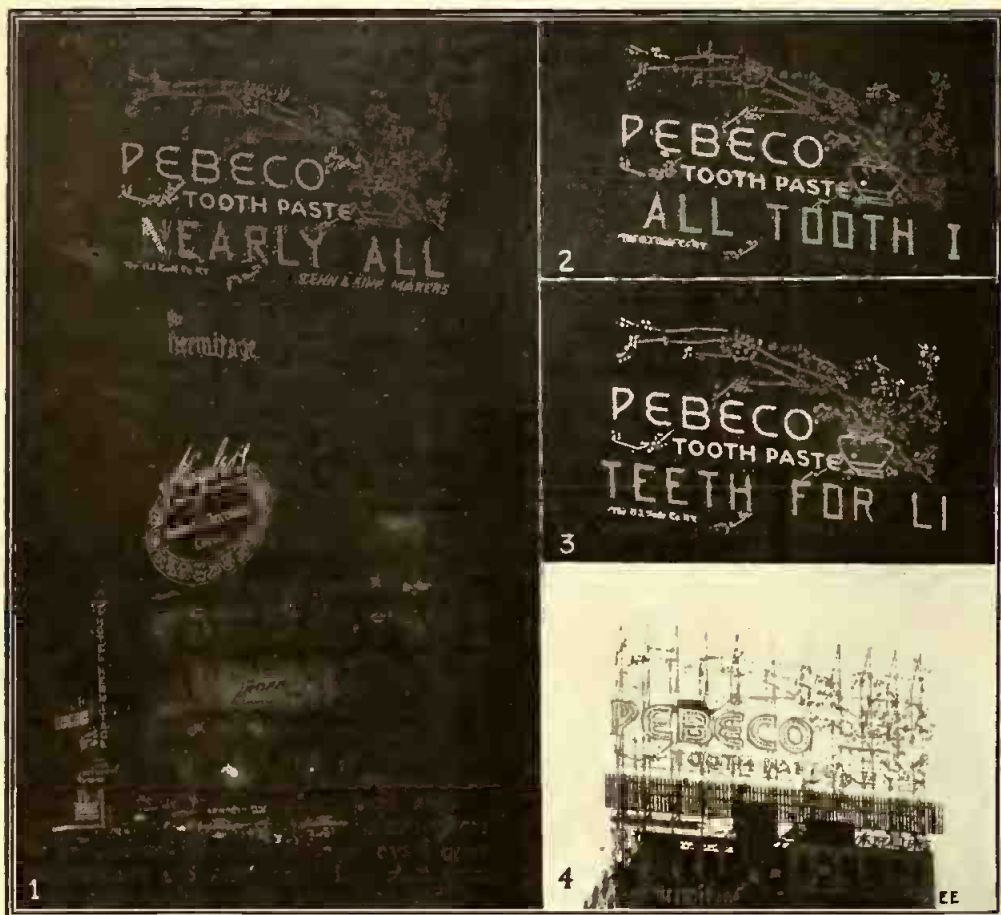

Changing Night Effect and Daytime Appearance of New Electric Sign in New York City that Spells Out Successively Continuous Sentences.

novel advertising attraction which, of course, is only to be seen at its best at night time.

The sign is a large affair, measuring about 100 feet long by 50 feet high, and it is supported on a steel framework mounted on top of the Hotel Hermitage near Forty-first street and Broadway in the metropolis. The upper part of the sign does not possess any remarkable features, as may be seen by carefully looking over the illustrations herewith. At the bottom of the sign, however, as becomes noticeable in Fig. 4, is a band about 12 feet high and which extends clear across the face of the sign. This band (which is stationary) is made up of a series of narrow strips, on which are mounted vertical lines of electric bulbs. By a very ingenious flasher arrangement, due to the engineers of the O. J. Gude Co. and on which it is understood patents have been issued, it is made possible to cause a letter, a word or a sentence to flash across this normally black band from right to left, i. e., it is spelled out in front of the spectator's very eyes, the letters apparently forming at the right and slowly traveling across the face of the sign, each letter being followed by its complement in forming a word, etc.

This sign has attracted greater crowds than probably any other like advertisement ever erected on Broadway for many a day. It is so unique that it is bound to catch the eye of nearly every passerby, no matter how much in a hurry he is or how intent on his business.

this highly ingenious sign we may glance at Fig. 1. Here we see the words "nearly all," which form part of a Pebeco advertisement sentence. To start with, only the "N" is observed, and this is formed at the right and gradually slides over toward the left, the E-A-R, etc., following each other consecutively and in their proper sequence with respect to one another.

One of the best effects obtained with this sign is at the close of a certain sentence when the active part of the display becomes totally dark, when the letters forming the end of the sentence appear to literally slide off into the darkness of the night.

It is understood that the switching control of this spectacular display is arranged somewhat on the order of a player-piano, with perforated paper roll, which passes through a special switch arrangement in a manner which becomes apparent to any electrician. A vast amount of work is necessitated in designing, installing and operating such a display, and this is more clearly emphasized when we consider that practically every lamp in the active (spelling) part of the layout has to have a wire brought from it to the switch-control booth on the roof of the hotel. Most of these elaborate sign effects require a staff of several electrical experts to operate and care for the complicated and intricate switch gear utilized in cutting in and out the proper lights.

The sign is in the theatrical section and, therefore, commands nightly a vast audience.

HEARS JAPAN WIRELESS MESSAGE AT GREAT LAKES, ILL.

Sitting at the desk in the new wireless station at Great Lakes, Ill., at 4.10 o'clock on the morning of Oct. 1 last, G. F. Reiling, one of the wireless operators, heard one of the new stations in Japan, about 5,000 miles distant, talking to Kokoa Head station in the Hawaiian Islands. He also declares he heard a wireless telephonic message from Mare Island, Cal.

That there is no doubt about the efficiency of the new wireless station at Great Lakes is seen by the fact that Reiling gives word for word the message which he heard flashing from the Japanese station, as follows:

"Hello! Hello! How do you hear me? How are you? What do you want? Please copy: 543210. Do you get this? Please copy (repeats figures) that's all; that's all. Good-bye."

Reiling worked the same morning at 4 o'clock with the San Diego, Cal., station and the operator there told him that the message sent out from Great Lakes station was heard very distinctly. He in turn, at Great Lakes, could hear the California message very plainly.

The Great Lakes station is in daily schedule with San Diego and Arlington, Va., and the clearness of the messages sent so far has caused officials at the station to feel that the local plant is about as efficient as any in operation at any place in the country.

STEEL JACKET CATHODE HELPS COOL X-RAY TUBE.

One of the principal troubles encountered in modern X-ray work and particularly where medium or small sized tubes are utilized, lies in the large amount of heat generated within the tube, and especially at the cathode electrode. In some cases water cooling is resorted to, in an effort to help cool the tube, and electric fans are also employed in a similar effort. It has remained for a western X-ray concern to bring out a very simple device which seems to possess considerable prom-

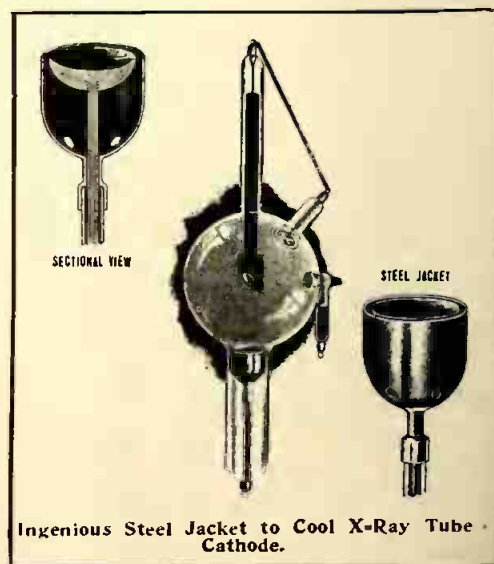

ise in an effort to reduce the heating in such tubes.

This device, the new Kesseling tube, comprises simply a steel jacket, as illustration shows, which surrounds the cathode electrode proper. The heat produced by the cathode is conducted through the steel jacket and thence along the electrode rod and so out of the tube. This device is of low initial cost and much simpler than many other schemes advocated and employed for this purpose.

High Frequency Currents and Apparata

(Concluded)

At Fig. 7 is shown how a 16-cp. 110-volt incandescent lamp may be lighted through the body by a high frequency coil. A piece of copper wire is firmly held in the mouth for this somewhat startling experiment and it is also joined to one terminal of the incandescent lamp. A second wire is con-



Fig. 7. Lighting 110 Vt. 16 C.P. Lamp Thru the Body by High Frequency Current.

nected from the other terminal of the lamp to the high frequency transformer. When the proper adjustments have been made on the high frequency set it will be found possible to bring the lamp up to full brilliancy. The Oudin connections are invariably employed for this class of experiments where lamps are lighted, sparks al-

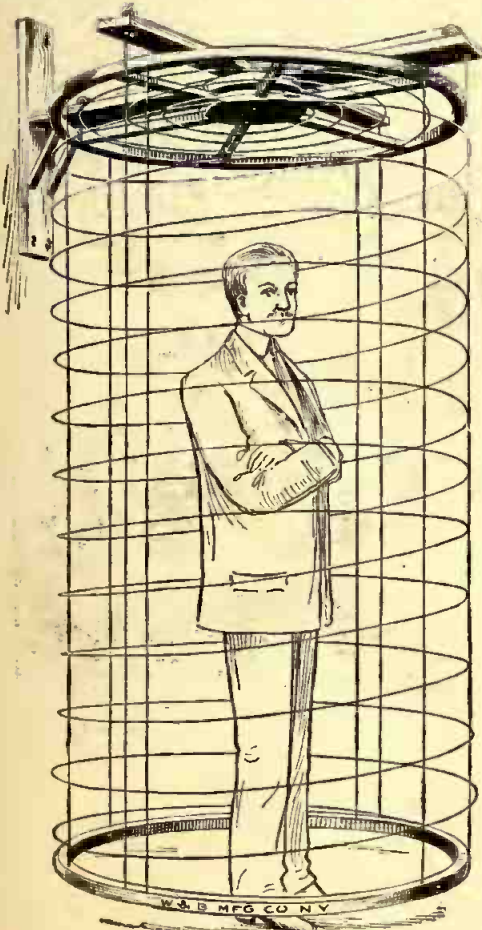

Fig. 10. Large High Frequency Cage Used for Electro-Therapeutical Treatment.

lowed to jump to the hand, etc. A word of caution should be mentioned here, as these high frequency sparks will burn con-

siderably when allowed to jump directly to the skin. In any case, a piece of metal should be held in the hand. No severe shock is experienced in the passage of such high frequency currents through the body as long as they are properly handled by allowing the spark to enter the body through a metal electrode, as stated, and providing the frequency is high enough. Experiments have been conducted where half a million volts were passed through a man's body with several amperes of current. Even with a small high frequency set, lighting a 32-cp., 110-volt lamp, then one ampere of current is passing through the body. With this current, as indicated on a hot-wire ammeter (and which also has the effective current value of one ampere), it is quite possible that it may have an instantaneous maximum value of as much as 160 to 170 amperes. This is due to the very rapid discharge of the condensers in the circuit, and if large enough electrodes are used on the skin no burning effect will be felt.

Rather spectacular high frequency discharge effects are portrayed at 8 and 9. These are usually produced by using an Oudin transformer giving a powerful unipolar discharge at high frequency and ultra-high potential. In the experiment at Fig. 9 a metal piece is held in the hand and a flame discharge from same leaps forth into space. The body of the man is here charged at very high voltage by connecting the high frequency terminal of the Oudin transformer to his ankles through a couple of metal ankle straps. He is best seated on a glass platform for this experiment, and all of the adjustments in the high frequency transformer circuit must be very carefully made in order to produce these fine effects, and the inductance of the primary exciting transformer is very important. It is quite advisable, and in fact imperative in some experiments of this nature, to use an adjustable impedance coil in the primary of the exciting step-up transformer, so as to be able to tune it properly with respect to the high frequency circuit. The wonderful effect produced at Fig. 8 is also an Oudin coil phenomenon, and a very fine spray is seen to branch out all around the top of the high frequency coil. This effect is truly marvelous and can only be fully appreciated when observed at first hand. No photograph, and especially a half-tone as here printed, can do justice to the weird and awe-inspiring effect produced in this way. In this experiment a person can approach carefully the highly charged Oudin coil and part of the spray will discharge through the head without any appreciable shock as long as the person does not come too close.

In the electro-therapeutical application of high frequency currents by the medical profession there is often employed a large wire cage of sufficient size to enclose the subject's body as Fig. 10 shows. The high frequency current from an Oudin or Tesla machine is passed through this large helix and powerful currents are induced in the subject's body, and in this way are produced valuable results of an electro-therapeutical nature for various kinds of ailments and diseases. This method is one of the best known to medical science for the treatment of arteriosclerosis, or as it is commonly termed, "hardening of the arteries." Dr. D'Arsonval, the noted French scientist, has made numerous measurements in this direction and has proved by tests on different male and female patients

that, after a few treatments of this kind, the blood pressure can be reduced quite markedly, and in most cases permanent lowering of arterial blood pressure is effected.

This large solenoid arrangement can be



Fig. 9. Wonderful Brush Discharge Effect Produced by High Frequency Current.

used to produce spectacular high frequency stunts and experiments, a common one being to let the person inside of the wire cage hold a Geissler tube in his hands so that the current produced in the body will pass through the tube from one hand to the other, lighting up same in a spectacular manner. If the cage is made sufficiently large, two or more persons may stand within same and Geissler tubes placed in their hands so as to complete the circuit



Fig. 8. Another Beautiful and Spectacular Effect Produced by an Oudin Coil.

from one body, through a Geissler tube, to the next body, etc., giving a very interesting effect for stage and lecture purposes.

Many other remarkable and interesting (Continued on page 449.)

Figs 7, 8 and 9, reproduced from "Electricity at High Pressures and Frequencies," by Henry L. Transtrom.



RADIO DEPARTMENT



The Radio Transmitting Set at Arlington, Va.

THE powerful Government wireless telegraph station operating at Arlington, Va., and rated at approximately 100 kw., utilizes a synchronous rotary spark gap and a number of other unique apparatus especially designed to handle such a large amount of power in the most efficient manner possible. This installation was supplied by the National Electric Signaling Co., exploiting the patents of Prof. Fessenden. One of the basic patents embodies a synchronous rotary spark gap mounted on the end of the generator-shaft or similarly disposed so as to cause the spark to occur in an exact relation at all periods with respect to the reversal of current in the alternating current transformer (primary) circuit. This has been found essential for the best result in any case and is always superior to any non-synchronous rotary spark gap. The

very large and are composed of hollow copper tubing. In shifting or adjusting these large tuning inductances, recourse is had to a rope or a belt and countershaft which rotates the drums on which the coils are wound. Electrical contact can be made with any part of a turn as desired by means of a rolling wheel or trolley. This is noticeable, particularly on the aerial loading inductance observed at the extreme right of the photograph.

The rotary spark gap of heroic size rotates at 1,200 R.P.M. and contains two stationary spark electrodes which are fitted with two insulated water cooling systems to help extinguish the spark abruptly, which, of course, is conducive to the most efficient operation of any wireless transmitting set. This rotary gap is enclosed within a guard ring of large size and in which the stationary electrodes of the gap are mounted in

When a break-down occurs in such condensers as these they possess a self-healing or self-restoring dielectric characteristic, and in operation it is merely necessary to keep the compressed air at so many pounds' pressure within the tanks. The metal tanks are of very rugged construction and the condenser plates within them are suspended from the covers, which are bolted to the tank proper. One set of plates is grounded to the shell, while the alternating plates are connected through a heavily insulated terminal, as perceived from the illustration. This plant is probably one of the most powerful and efficient extant today and the wireless time signals sent out at noon and 10 P. M., Eastern time, daily are now received by thousands of experimental and commercial radio stations throughout the United States, and also by ships at sea in all parts of the Atlantic

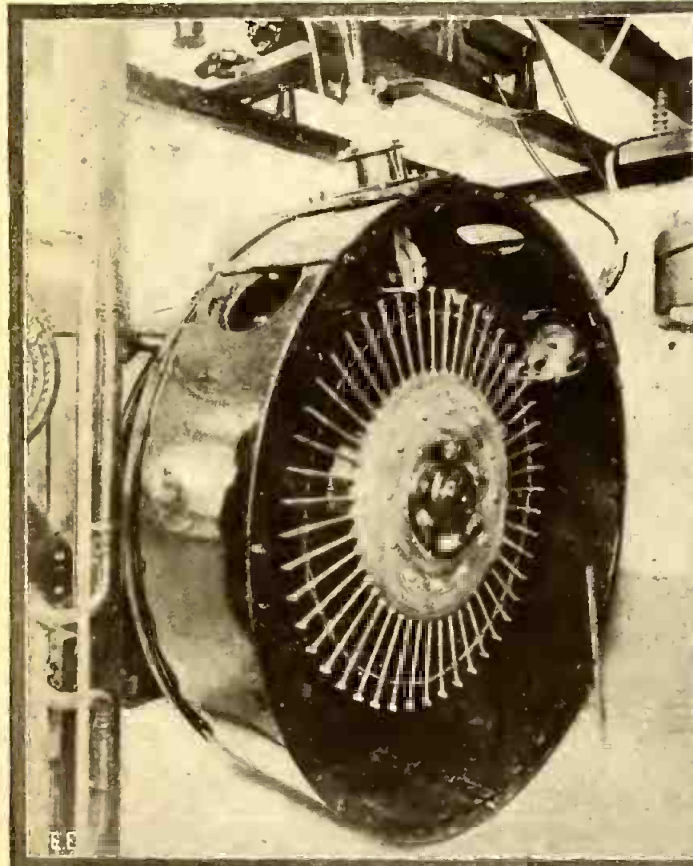

At Left: Close-up View of Synchronous Rotary Spark Gap on 100 KW. 500 Cycle Radio Transmitting Set at Arlington, Va. From this Mastodon Spark Gap 1s Sent Out the Radio Time Signals and Weather Reports That Spread Broadcast Over the United States and the Atlantic Ocean Daily.

Below: General View of the 100 KW. wireless Transmitting Set at Arlington. Tanks Below are the Compressed Air, Fessenden Type, Condensers. Water Cooling Tanks for Spark Gap are Seen Over Dynamo. Hot Wire Radiation Ammeter is Observed in Foreground on Post.

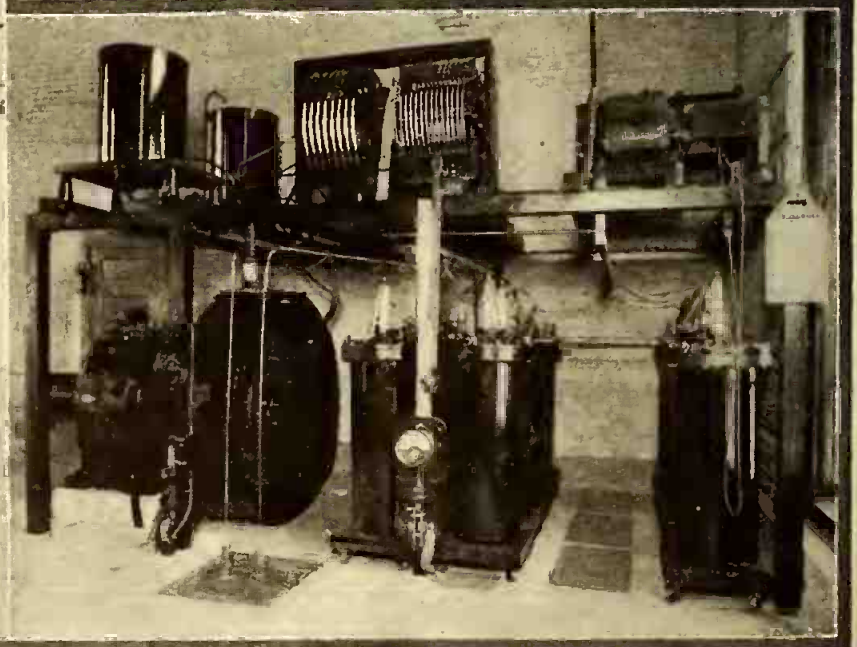

Photos Copyright by Underwood & Underwood.

two illustrations herewith depict the extra large synchronous spark gap used at Arlington in transmitting time signals, and the other view shows the spark gap itself mounted on the shaft of the 500-cycle alternator, together with the large-size oscillation transformer and aerial loading inductance, as well as the compressed air condensers of the Fessenden type, which resemble steel boilers or tanks, as perceived. The radiation hot-wire ammeter is mounted on the wood post shown in the foreground of the general view of the transmitting set. The tuning oscillation transformer and the loading inductance are

extra large insulated bushings. This form of construction has many advantages, and one in particular is that allowing the stationary electrodes to be moved through several degrees with respect to the rotating spark wheel, and in this way the sparks proper can be made to occur at practically any point desired in the alternating current cycle passing through the step-up transformer which charges the condensers and, likewise, this spark gap circuit.

The condensers used with this set, which are, as aforementioned, of the compressed air type, have many advantages over other types employing glass as the dielectric.

Ocean. Signals from this station have been received under good conditions at the Eiffel Tower radio plant at Paris, France. It has been stated a number of times that the time signals and weather reports as picked up from the Arlington station are much clearer and more easily read over long distances than those transmitted by the Eiffel Tower station at Paris, or from any other high-power radio station now in operation. This service is of inestimable value to the merchant marine and also to the naval service, enabling the chronometers on board ship to be correctly checked twice each day.

U. S. Army Field Radio Set

THE photographs and diagram herewith show the general appearance and also the connections of the various parts making up the portable radio pack set as used by the U. S. Signal Corps.

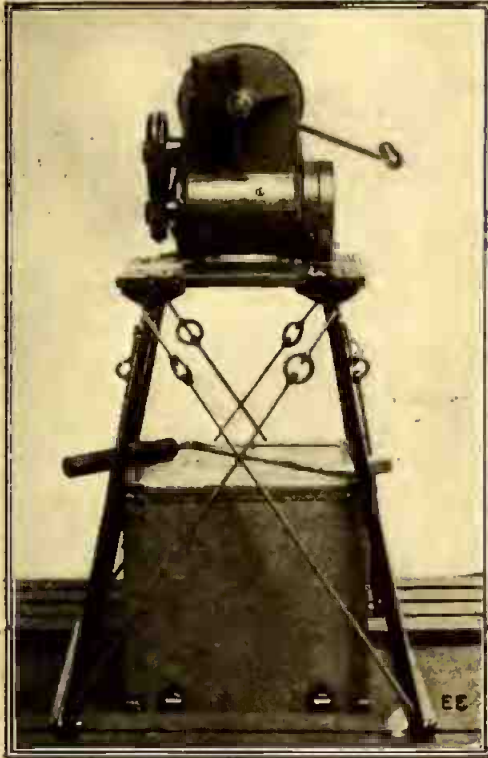

Fig. 1. Compact 250 Watt Hand-driven 500 Cycle A. C. Generator Used to Supply Power for U. S. Signal Corps Radio Pack Set.

Fig. 3 as used with this set, they in general follow regular radio engineering practise. As will be evident, there is employed for receiving a switch type loose coupler with primary and secondary windings, and several unique features not commonly found, on experimental radio sets at least, are herewith to be noted.

Among these features is the inductive coupling of the *buzzer test* with the primary coil of the loose coupler. This is arranged on any receiving set very easily by simply winding a few turns of wire around the primary coil or by placing these few turns of wire at the end of the primary, so as to react on same by induction. Another feature which works very nicely, and also one that is invariably used on all commercial radio sets nowadays, is the *safety spark gap* placed across the aerial and ground connections of the receiving apparatus proper. Any heavy static or lightning discharges will jump this gap in preference to passing through the high resistance and reactance of the coupler windings. This indirectly protects the sensitive and expensive headphones, as well as the mineral detector. Also in some cases where such protective spark gap were not used it has happened that the coupler was burned out by an extra heavy static surge through the circuit, occasioned by the close proximity of an electric storm while operating the set.

A simple aerial switch effects the change-over from transmitting to receiving set. The transmitting apparatus is very simple and will be readily understood from the diagram. It comprises a primary coil in the oscillation transformer, and this reacts by induction on three secondary spirals, any one or all of which may be joined in the

cated clearly, and the step-up transformer of the *resonance type*, especially designed for this work, is air insulated. Alternating current of the proper voltage and 500 cycles frequency is supplied by the hand-driven self-exciting generator previously described. This machine is fitted with an automatic centrifugal cut-out switch which does not permit operating the set until the

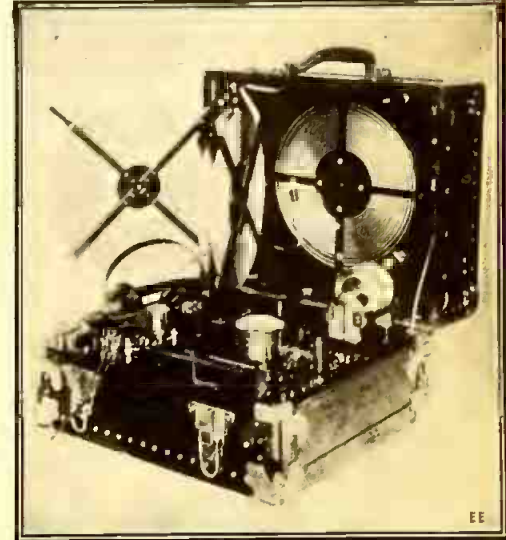

Fig. 2. Showing Neat Arrangement of Complete Portable Radio Transmitting and Receiving Apparatus in Army Pack Set. Note Use of Several "Pancake" Style Helices.

proper speed is reached, and consequently the critical frequency produced by the dynamo. This is necessary for several reasons when maximum efficiency is to be at-

The photograph Fig. 1 illustrates the hand-driven dynamo, rated at 250 watts, which can be disassembled in a few minutes so as to be readily packed on a mule's back. Photograph Fig. 2 shows the very compact arrangement of the transmitting and receiving apparatus, including the quenched spark gap, oscillation transformer and loading inductance, the latter being of the flatwise wound ribbon type. These pancake coils forming the oscillation transformer can be swung toward or away from one another, as they are mounted on hinges. On the shelf in the cabinet containing this apparatus is mounted the spark gap, as well as the radiation hot-wire ammeter and the transmitting key. Under the shelf there is mounted the receiving apparatus inductance, and also the step-up transformer of the sending set, as well as the high tension condensers, etc.

Switching means are provided on this set for quickly throwing the aerial and ground terminals onto the receiving or transmitting apparatus. All of the instruments used in the make-up of this outfit are first-class in every particular, the best possible being purchased, as becomes requisite for military requirements.

The small-size hand-driven dynamo utilized in this set can be operated by two men nicely, and is especially geared up with enclosed gears as perceived, so as to give the proper speed when the crank handles are turned at a fair velocity. This style of radio pack set can transmit 20 to 30 miles under average conditions, and can receive over distances of a couple of hundred miles or more in connection with the collapsible mast and antenna wires used in conjunction with it. The whole outfit, including the mast, can be erected in a few minutes' time, ready for service.

Referring to the diagram of connections

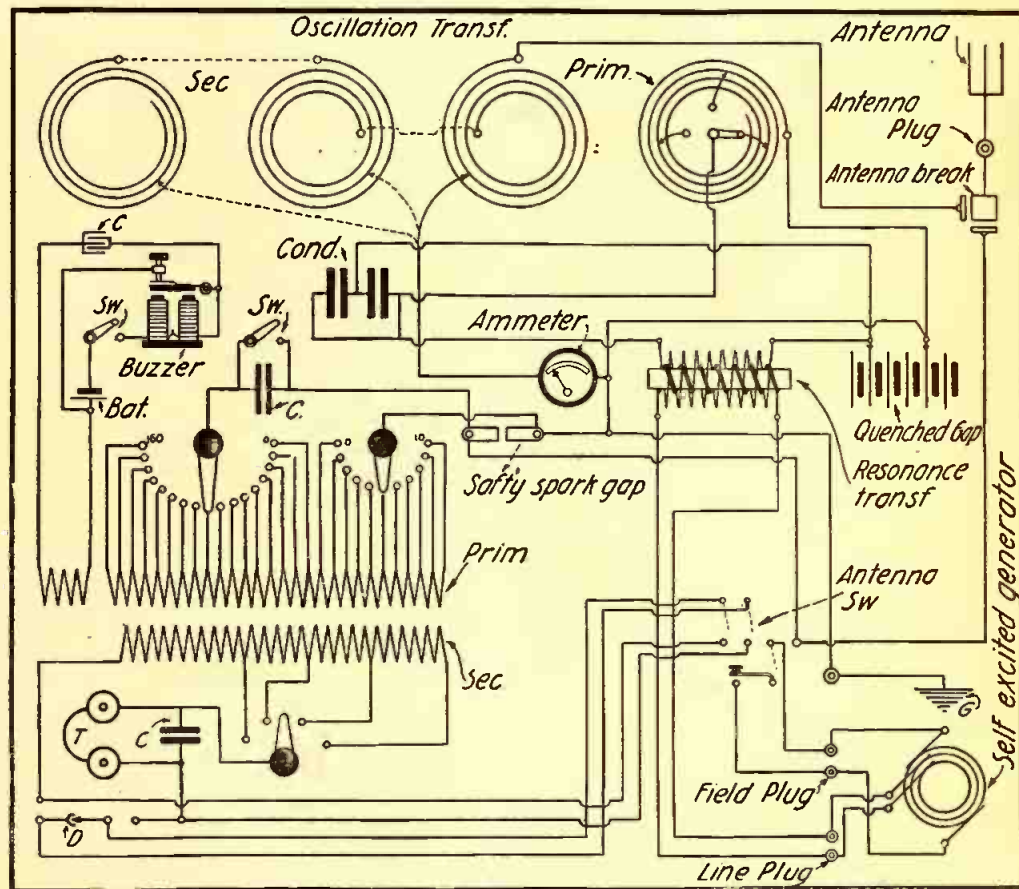

Fig. 3. Diagram of Connections for Transmitting and Receiving Instruments in Radio Pack Set. Note "Buzzer Test" Inductively Coupled.

circuit as different wave lengths are required. The quenched gap, condenser and hot-wire ammeter connections are indi-

tained by such a set, and particularly due to the utilization of the resonance type of transformer incorporated in this design.

Marconi Company Develops New 2-KW. Radio Panel Set

The accompanying illustrations show, respectively, the front and rear views of a newly developed 2-kw. radio transmitting set of the quenched-spark type as brought out by the Marconi Wireless Telegraph Co. This set marks the latest advance in wireless outfits of this type. As will be observed, all of the apparatus for both the primary and secondary transmitting circuits are mounted behind the switchboard panel. This conduces to the interchangeability of the outfits for installation on ship-board, and also it permits of using short leads for connecting up the apparatus, and in this way undue losses are obviated.

which move over calibrated scales marked off in wave lengths.

Variation in the coupling between the primary and secondary coils of the oscillation transformer is effected by the control handle and needle, which are mounted directly above the quenched-spark gap.

On the lower front of the panel are mounted the necessary motor-generator switches and starting solenoid, as well as overload relay. The usual ammeter and voltmeter for the primary circuit of the alternating-current transmitter are mounted on the front of the panel, as well as slider type rheostats for the field circuits of the

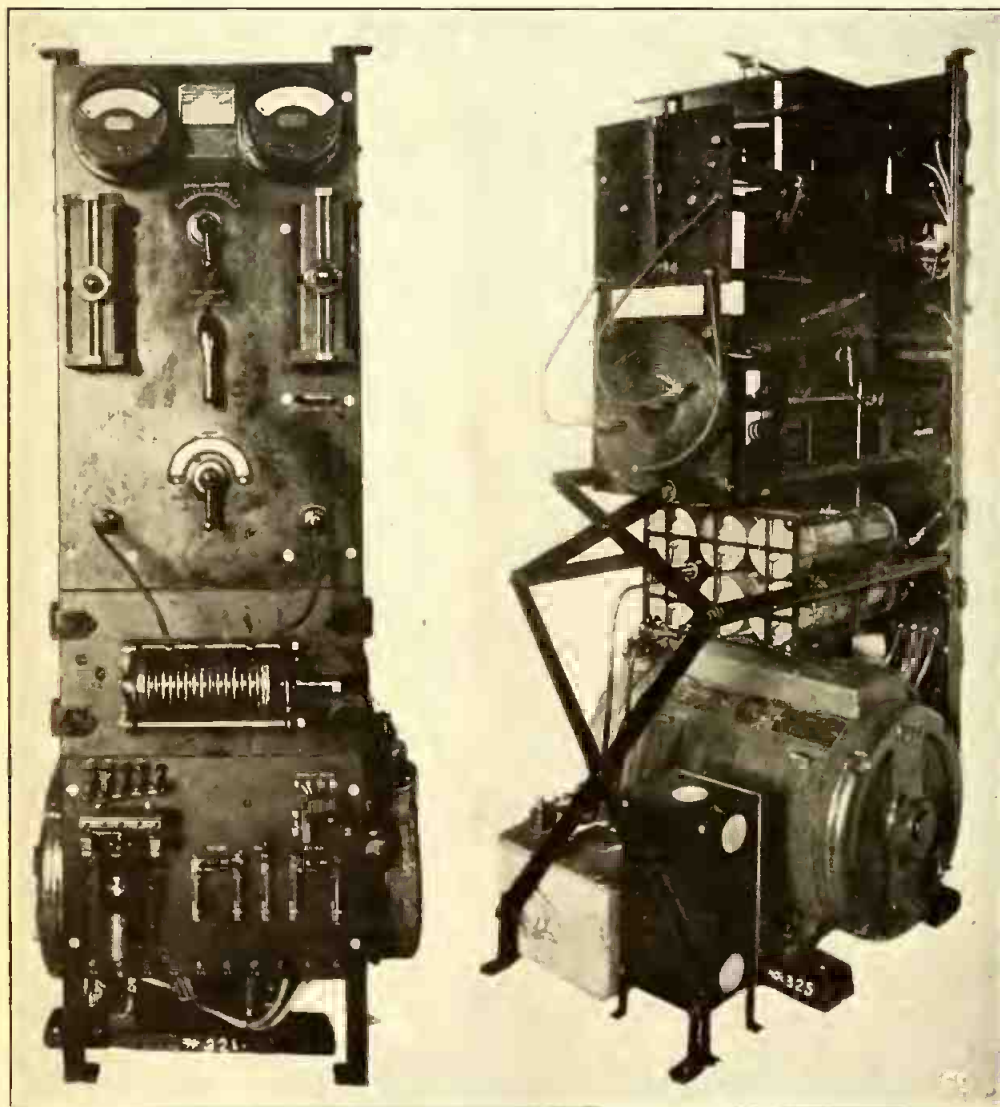

Front and Rear Views of New Marconi 2-KW. Radio Transmitting Panel Set.

This is a very important consideration in the high-potential, high-frequency circuits.

The motor-generator set is seen at the bottom of the photograph in its cylindrical casing. Above it are mounted, in a special rack, the Leyden jar condensers. Back of the motor-generator set is placed the step-up, high-potential alternating-current transformer, which is provided with a protective spark gap fitted with ball terminals. On the upper rear section of the panel is mounted the oscillation transformer, made up of a spiral copper strip moulded in a special insulating disc, and also a large loading inductance for the aerial circuit used in transmitting long waves is incorporated in this part of the apparatus. The wave lengths are controlled by suitable handles on the front of the switchboard panel, as the illustrations indicate, and these handles are fitted with indicating needles,

motor and generator. This, as will be seen, forms a very desirable and compact set, readily adaptable to ship and other requirements which in most cases permit of very little space for the installation of the radio apparatus.

FESSENDEN INVENTS SUBMARINE RADIO.

Professor Fessenden, of Boston, claims to have invented a contrivance for sending wireless messages from battleships to submarines at a distance of 32 miles under water. By experiments he hopes to increase the distance very considerably. He states that the appliance can also detect the sound of submarine propellers at a distance of two miles, which can be increased to five miles by means of a sound-amplifying contrivance. This, he says, would be useful in detecting enemy submarines.

A HUGE OIL TYPE RADIO CONDENSER.

The large oil insulated condenser herewith presented is of the non-variable type and consists of a large number of zinc plates separated by glass plates. The conducting plates are bolted together in the usual manner. The condenser is placed



Large Size German Make Oil Type Radio Condenser.

in a container in which oil is used as a dielectric. Each condenser acts as a single unit and any number of them can be shunted across the two metal conducting tubes, as shown above the containers. Each one is properly insulated, as can be observed.

These condensers are now extensively used in the German wireless stations, as they are very reliable. Note that hollow tubes are used to give low resistance for the high frequency currents, which, as we know, only travel on the surface of a conductor.

PHOTOGRAPHING RADIO WAVES.

Various methods have been suggested and some actually developed for recording incoming wireless waves. These were generally unsuccessful, due to the fact that the messages had to be transmitted at a slow speed. Finally a photographic recording scheme has been developed whereby the waves are photographed upon a moving strip of film. This apparatus here shown consists of a camera, a string galvanometer, mechanically-driven photographic film strip and a beam of light from an incandescent electric lamp.

The operation of this instrument is as follows: The galvanometer is connected to the receiving instruments in place of the regular receivers and a beam of light is set upon the mirror of the galvanometer. Now the film is passed before the reflected light of the mirror by starting the mechanical motor. If there are messages in the ether, the galvanometer string will oscillate in accordance with the incoming waves and in turn deflect the reflected light on the film. After the message is finished the film is developed and fixed as in the ordinary photographic process. It will be found that the dots and dashes

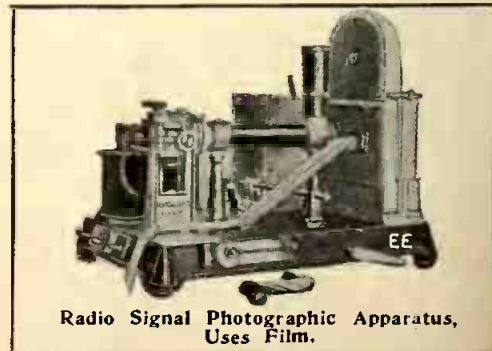

Radio Signal Photographic Apparatus, Uses Film.

are all connected in one continuous wavy line.

This method of recording wireless signals is very accurate, durable, and high speed signals can be successfully copied. It was found that 150 words per minute can be readily recorded in this way.

A New Vibrating Reed Radio Amplifier

By Homer Vanderbilt

The greatest desire of the present wireless "bug" is to have some means of amplifying the incoming radio signals to such an intensity that he may remove his headphones and still be able to hear; also

plating it, after which the cup is soldered fast and a small polished carbon button is fitted snugly into it.

ment if once set.

It is hoped that this may lead to further research on the part of other radio "bugs" along this line, as the writer's experiments with a rather crudely made model, con-

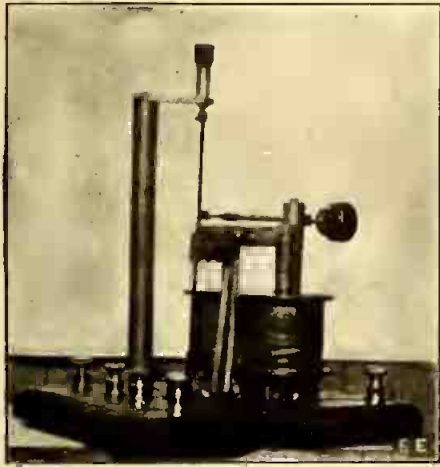

Fig. 1. Photo of Vibrating Reed Amplifier.

thereby making it possible for any interested friends to "listen in" at the same time. Many such devices have recently been developed, but most of them have proven failures, while the cost of others is far beyond the means of the average experimenter.

The amplifier herewith described was developed after some research work, and below is explained briefly the building of the complete apparatus, the photo at Fig. 1 being the completed instrument and Figs. 2, 3, 4 and 5 depicting the construction in detail.

By referring to B in figures it will be noted that two electro-magnets B B are made up from a couple of soft iron cores $\frac{1}{8}$ inch in diameter and 8 inches long. A pound of No. 24 B. & S. insulated copper wire is wound on each. The bobbins measure $3\frac{1}{2}$ inches between end cheeks. On one end of each core there are two strips of soft iron L L for supporting the coils C. These coils and their soft iron cores are obtained from a wireless receiver (having 3,000 ohms resistance), and are held in place by means of two No. 8-32 machine screws as shown. The two large electro-magnets are supported on a soft iron yoke P (see Fig. 2).

The armature is supported by two No. 40, or better, No. 45 B. & S. copper wires E E, which are soldered to each end of it. The free ends are fastened to an adjusting attachment G, which consists of an 8-32 threaded brass rod having on one end a small hole for inserting the copper wire E, and the rod G slides through a small tube N. This tube is soldered to the bar M and standard F. The rod F is supported by a square base of wood A, having also a small wire support Q and set screw.

The other standard K supports the second carbon point I by means of an 8-32 threaded brass rod, which is used to regulate the pressure between the carbon electrodes.

As will be noted, seven binding posts are employed, three of which are connected from the electro-magnets, two from the high-resistance coils, while the other two lead from the microphonic points I and II.

Fig. 5 explains the connections of each part and, as is seen, one coil of the electro-magnet is connected in series with a buzzer and battery and the other is hooked up directly across a set of storage batteries giving about 8 to 10 volts. The sensitive high-resistance coils are connected to the regular receiving apparatus in place of the head receivers, while the microphonic electrodes are wired in series with a 5-ohm telephone receiver (having its permanent magnet removed) and a small horn attached to its cap.

The operation is as follows: When the current is sent through one coil the iron armature is twisted and attracted at that point. As soon as the buzzer is operated (which produces an alternating current in the opposite coil) it starts the

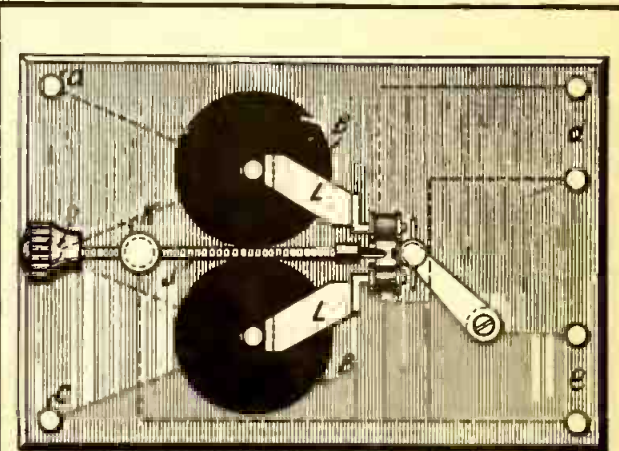

Fig. 3

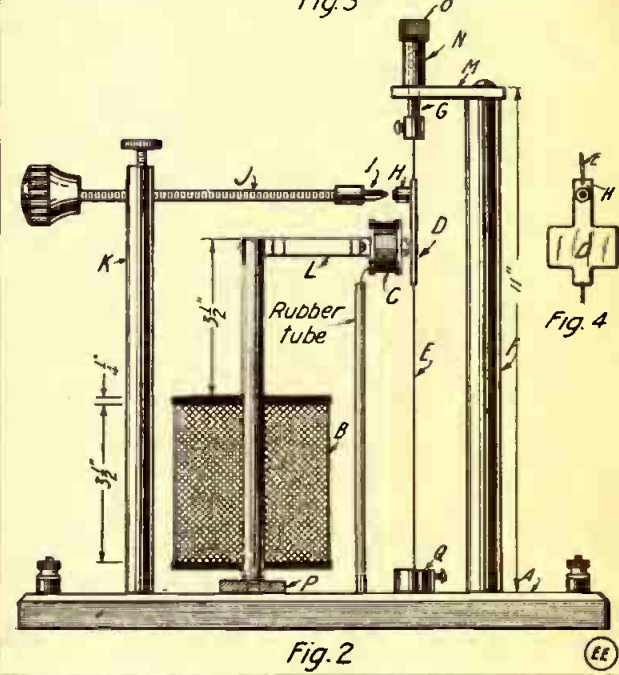

Fig. 2

Side and Top Views of Amplifier, Showing Suspension of Reed.

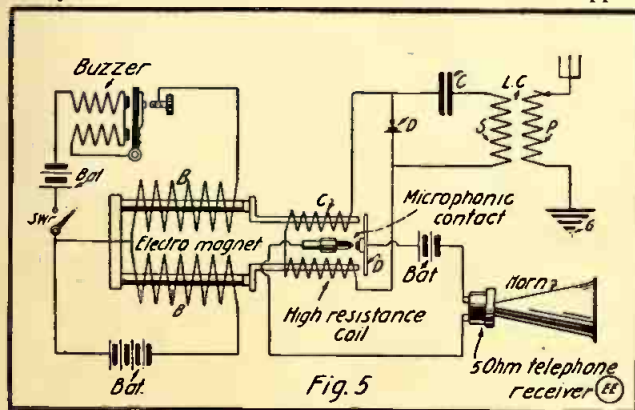

Fig. 5. Diagram for Amplifier.

The armature D, as we see from Fig. 4, consists of a thin strip of soft iron (about No. 34 gauge), cut as may be perceived. A small cup H, made from brass, is now fastened to the armature. This is done, first, by thoroughly cleaning the upper portion of the armature and then copper-

plating it, after which the cup is soldered fast and a small polished carbon button is fitted snugly into it. The armature is supported by two No. 40, or better, No. 45 B. & S. copper wires E E, which are soldered to each end of it. The free ends are fastened to an adjusting attachment G, which consists of an 8-32 threaded brass rod having on one end a small hole for inserting the copper wire E, and the rod G slides through a small tube N. This tube is soldered to the bar M and standard F. The rod F is supported by a square base of wood A, having also a small wire support Q and set screw. The other standard K supports the second carbon point I by means of an 8-32 threaded brass rod, which is used to regulate the pressure between the carbon electrodes. As will be noted, seven binding posts are employed, three of which are connected from the electro-magnets, two from the high-resistance coils, while the other two lead from the microphonic points I and II. Fig. 5 explains the connections of each part and, as is seen, one coil of the electro-magnet is connected in series with a buzzer and battery and the other is hooked up directly across a set of storage batteries giving about 8 to 10 volts. The sensitive high-resistance coils are connected to the regular receiving apparatus in place of the head receivers, while the microphonic electrodes are wired in series with a 5-ohm telephone receiver (having its permanent magnet removed) and a small horn attached to its cap. The operation is as follows: When the current is sent through one coil the iron armature is twisted and attracted at that point. As soon as the buzzer is operated (which produces an alternating current in the opposite coil) it starts the other end of the armature vibrating. Now adjust the carbon point I by screwing the knob on threaded rod J until a slight click is heard in the receiver. At this point, without touching any part of the amplifier, connect the 3,000-ohm coils to the wireless set. If there are signals in the ether, and picked up by the apparatus, they will be transmitted to the coils C, which will cause a break in the vibration of the armature, due to the alternating current produced in the electro-magnet, which consequently shortens the contact between the carbon electrodes and thereby making the "telephone circuit" complete. This will produce a loud sound in the receiver. By very carefully adjusting the carbon contacts the signals can be readily amplified without any trouble. A good point about this amplifier is that it will not jar or break its adjust-

ment if once set. It is hoped that this may lead to further research on the part of other radio "bugs" along this line, as the writer's experiments with a rather crudely made model, constructed as here outlined, seemed to possess considerable promise.

INSTITUTE OF RADIO ENGINEERS PACIFIC COAST MEETING.

On Thursday and Friday afternoons, Sept. 16 and 17 last, joint meetings of the Institute of Radio Engineers and the American Institute of Electrical Engineers were held at the Native Sons of the Golden West Hall, Panama-Pacific Exposition grounds, San Francisco. Two papers for the radio engineers were presented, one on each day. Thursday afternoon Prof. Harris J. Ryan read the results of investigations on the "Sustained Radio Frequency High Voltage Discharge," by Roland G. Marx and himself, taking up the flame and brush types of discharge obtained from conductors when a powerful arc generator is used to apply voltages up to 50,000 at frequencies as high as 200,000 cycles per second. On Friday Robert H. Marrjott, of the United States Naval Radio Service, read a paper on "Radio Development in the United States," giving special attention to Pacific Coast conditions.

THE TELEFUNKEN PERMANENT CRYSTAL DETECTOR.

A form of crystal detector which has been used for some time in the Telefunken radio receiving sets as supplied to various army and navy signal corps, and also in use in the United States Signal Corps radio

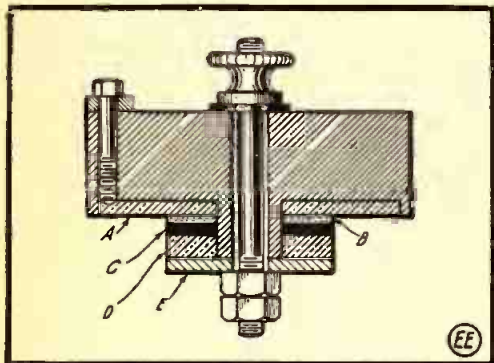

Make-up of Telefunken "Permanent" Mineral Detector.

pack sets, has interested undoubtedly more than one experimenter who has seen one of them. The particular reason why this detector is very little known is due to the fact that once it is adjusted and made up in the laboratory it is sealed and is not supposed to be opened by anyone, even the Government operators. We present herewith a diagram showing how this crystal detector is made up, and besides being robust in construction it is also extremely sensitive and compares well with the audion.

Referring to the sectional view of this detector shown herewith, A is a washer serving as one terminal of the device, while B is a plate of sensitive mineral material, such as galena. At C is placed a thin perforated mica disc, while D is a brass, graphite or other washer whose surface next the mica is corrugated and silvered. When sufficient pressure is applied to this device the corrugated surface of D comes in contact with the mineral B, thus providing several rectifying parts for the received oscillations of the radio receptor circuit. The washer E allows the whole to be screwed up tightly, as perceived. No auxiliary battery is necessary for this detector and it is connected into circuit in the same way as the galena detectors, with which practically all experimenters are familiar. Two of these detectors are usually provided in the Telefunken sets and they are connected with a throw-over switch, so that if one should fail for some reason, the second detector may be immediately switched into circuit.

NAVAL RADIO STATIONS.

The opening of the new naval radio station at Darien, Isthmian Canal Zone, adds to the facilities for the transmission of Government messages, but does not extend the commercial service. The Navy Department, in advising the Department of Commerce of the opening of the station, offers to transmit free all official messages to or from points in the Canal Zone from or to points in the United States.

Out of a total of 47 naval radio stations which are now in use in various parts of the United States or possessions 21 are open to commercial messages, while the others are reserved for official business. In the Canal Zone there are two stations—at Balboa and Colon—which receive commercial messages, so that the new station need not enter that field in order to accommodate the public as the facilities are already adequate.

A list of the United States naval radio

stations, with their classes of service, is here presented:

Location.	Service.
Annapolis, Md.	Official
Arlington, Va.	Official
Balboa, Canal Zone.	Commercial
Beaufort, N. C.	Official
Boston, Mass.	Official
Cape Blanco, Ore.	Commercial
Cape Cod, Mass.	Official
Cavite, Philippine Islands.	Official
Charleston, S. C.	Commercial
Colon, Canal Zone.	Commercial
Cordova, Alaska.	Commercial
Darien, Panama.	Official
Dutch Harbor, Alaska.	Commercial
Eureka, Cal.	Commercial
Farallons, Colo.	Official
Fire Island, N. Y.	Official
Guam, Marianne Islands.	Commercial
Guantanamo Bay, Cuba.	Commercial
Honolulu, Hawaii.	Official
Jupiter, Fla.	Official
Key West, Fla.	Commercial
Kodiak, Alaska.	Commercial
Mare Island, Cal.	Official
New Orleans, La.	Official
Newport, R. I.	Official
New York, N.Y. (Brooklyn Navy Yard).	Official
Norfolk, Va.	Official
North Head, Wash.	Commercial
Olongapo, Philippine Islands.	Official
Peking, China.	Official
Pensacola, Fla.	Commercial
Philadelphia, Pa.	Official
Point Arguello, Cal.	Commercial
Portland, Me.	Official
Port Royal, S. C.	Official
Portsmouth, N. H.	Official
Puget Sound, Wash.	Official
St. Augustine, Fla.	Commercial
St. George, Alaska.	Official
St. Paul, Alaska.	Commercial
San Diego, Cal.	Commercial
San Juan, Porto Rico.	Commercial
Sitka, Alaska.	Commercial
Tatoosh, Wash.	Commercial
Tutuila, Samoa.	Commercial
Washington, D. C.	Official
Yerba Buena, Cal.	Official

* Station transmits time signals and weather reports daily.

Besides these the army of the United States, through its Signal Corps, has stations that are open to commercial business at Fairbanks, Alaska; Fort Mills, Philippine Islands; Fort St. Michael, Alaska; Kotlik, Alaska; Nome, Alaska; Petersburg, Alaska, and Wrangell, Alaska.

Plans have been made for radio communication between San Francisco and Manila by way of Honolulu, but work on that project will not be commenced until fall, and the section to Honolulu will not be in operation until a year from this time.

A naval station at Point Isabel, Tex., and Great Lakes Training School Station are under construction.

SPIRAL ANTENNAE FOR RADIO PURPOSES.

M. Bethenod, in *La Revue Electrica*, proposes the antenna arrangement shown

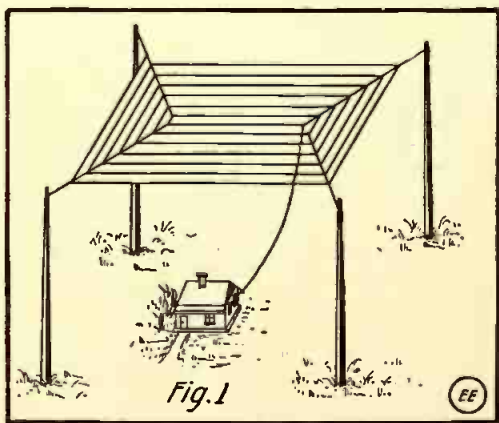

Fig. 1. Proposed Spiral Antennae for Radio-Telegraphy.

in Fig. 1, in which the antenna starts from the station building in the form of a single wire and is then arranged in the form of a spiral, in a nearly horizontal plane, by means of supporting cables as shown in the illustration. Fig. 2 shows an ordinary antenna consisting of 11 wires, the wave

length being 3,500 meters, in comparison with an antenna in which the spiral arrangement is employed, the wave length here being 5,500 meters. As will be seen, the construction is much simpler and re-

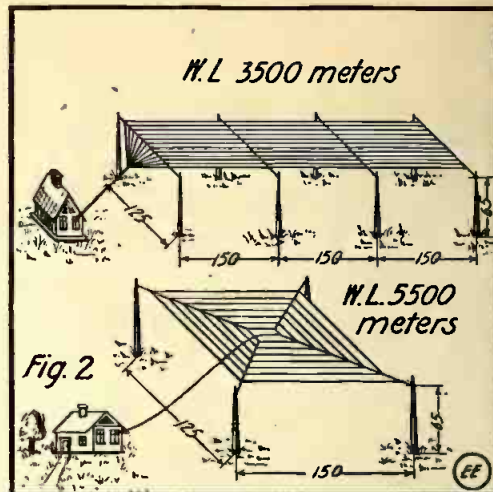

Fig. 2. Comparative Sizes of Spiral and Straight Types of Antennae.

quires considerably less space. The only inconvenience seems to be that a spiral antenna cannot be used with damped waves on account of the high tension which would be developed between the horizontal conductors.

THE RESISTANCE OF WIRELESS ANTENNAS.

A suggested explanation of increase of resistance of radiotelegraphic antennas which has been observed under certain conditions where the wave length is increased has been offered by L. W. Austin in a paper on the subject issued by the Bureau of Standards.

The resistance of radiotelegraphic antennas may be divided into three parts—first, the ohmic resistance of the wires; second, the so-called radiation resistance, and third, the so-called earth resistance.

Up to the present no satisfactory theory of ground resistance has been developed. The experimental curves of antenna resistance, on account of the decreasing radiation resistance, fall rapidly at first, as the wave length is increased, and then, as the wave length is further increased, remain nearly constant, if the ground conditions are good, as in the case of a ship's antenna, or again rise nearly in a straight line, if the ground conditions are poor. This rise may be very rapid in the case of peculiarly poor grounds. For instance, the resistance of the Bureau of Standard antenna rises from 13 ohms at 800 meters wave length to 38 ohms at 2,000 meters.

Great difficulty has been found in explaining this increase of resistance with increasing wave length, but it is believed that the antenna system must be looked upon as a condenser, the antenna itself being the upper plate and the ground water the lower plate. Between the ground water and the surface there is usually a layer of semi-conducting material, which would correspond to a poor dielectric in the case of an ordinary condenser. It is well known that the dielectric losses in imperfect condensers generally increase in proportion to the wave length of the current employed in the measurement. It is found that by covering the surface of the ground under and around the antenna with a wire net, thus making the lower plate of the condenser, ground losses nearly disappear.

Don't nickelplate your instruments. It increases the high frequency resistance and lowers the tuning efficiency.

SOME WIRELESS KNICK-KNACKS.

Very few amateurs care to invest in the hard-rubber support necessary when building efficient high-tension condensers. A good method is to build them as in Fig. 1. The plates are simply stacked one on

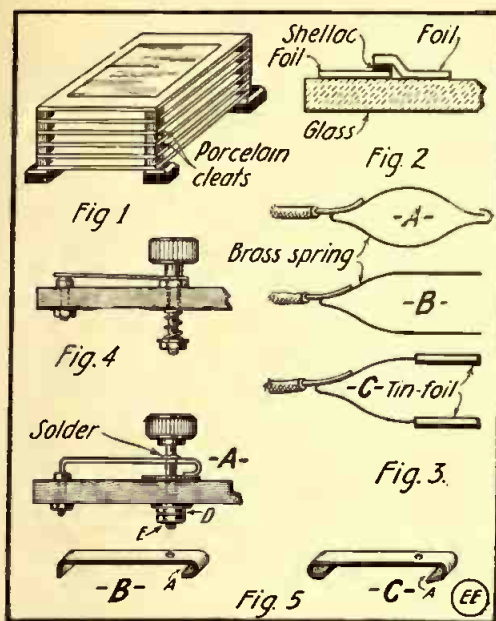

Useful Wrinkles for the Wireless Man.

top of the other, using porcelain cleats for separators.

I have visited quite a few amateur radio stations and it is surprising to learn how many experimenters tolerate brush discharges in their condensers. Some of them paint the edge of the foil with shellac, but this soon breaks down, due possibly to the shellac cracking when drying out.

The best plan is to dip the edges of the glass plates in hot paraffine until a quarter of an inch of the edge of the foil is coated; when dry and hard, dip again quickly (to make a thicker coat) and you will have no brush discharge. Your hot wire meter should now show a higher reading. It is well to construct a pan for coating these plates. The size of the pan will vary with the requirements of each amateur—a good size measures 18 inches long, 2 inches wide and 3 inches deep. A piece of "tin" for the purpose may be obtained from a clean five-gallon gasoline or kerosene can, which, when opened at the seams and bent to shape, will prove big enough for a large-sized pan.

When pasting the foil on the glass it is best to coat the glass with shellac, banana oil or other binder and then paste the foil on the glass, for if the foil is first coated and pasted the shellac forms an insulator between the foil sheets where they overlap (exaggerated in Fig. 2 to make clear). Of course, the foil might touch in one or more places, but this is insufficient for a quick discharge—a positively necessary action, since the law requires "sharp" waves.

Sometimes you will find that the surface of the contacts touching the foil is inadequate, and quite often it would arc at these contacts, burning holes which quickly enlarge and necessitate entire rebuilding.

These condenser contacts should be made of 3/8 or 1/2-inch wide spring brass or copper ribbon 1/32 inch thick and bent to shape as in Fig. 3, A or B. At least they should be made of some flat metal, and even then it is an excellent plan to wrap some scrap tin-foil about the spring where it comes in actual contact with the condenser foil; Fig. 3-C will make this clear.

Very often a "sputter spark," produced

in the gap when seemingly a sharp spark should be the result, is due to these faults in construction as explained above, and a change in such a small matter may make the set highly efficient. Like all other things, a wireless set is "no better than its weakest spot."

I was called on one time to look over a wireless receiving set which from all appearances should have given excellent results, but which was very unsatisfactory. After testing aerial, ground circuits and insulation, I found that the trouble was in the tuning coil. With unthinking zeal and haste, characteristic of the average amateur, he had painted the coil with some black enamel rich in carbon. I am not sure as to whether the turns were actually shorted, or if the trouble was due to the inductive effect. At any rate, when the coil was rewound with new wire, the set "got" long distance.

Another time I "saw" trouble for an hour before the trouble narrowed down to the detector. The crystal itself was good before and after mounting, for it has been tried in the test clamps.

The detector itself was a beautifully polished brass and marble affair and truly was a thing of beauty. We hooked up the detector in series with the battery and 'phones, and on withdrawing the point from the crystal the 'phones still showed a short. On dismantling the detector we found—with battery and 'phones—that there was an invisible vein of mineral from one post to another, running through the marble. All the holes in this detector were re-bored a little larger, bushed with hard rubber, and it has given no trouble since.

It is a good plan to bush all holes in marble bases, especially in high-tension switches. This course is usually unnecessary with manufactured apparatus for the imperfect ones are discarded, though I know of two instances where the purchased detector "leaked," and was repaired by the above method successfully.

In making radial arm switches for tuning coils, detectors, etc., it is a common practise to use simply a straight strip of brass or copper for the arm, with the necessary tension obtained by the use of some form of spring, usually a spiral spring inside of the case or switch, as in Fig. 4. The arm with this form of construction is never level and seldom looks well. A far better-looking, better-acting and much simpler plan is shown in Fig. 5. Bend the spring brass arm to the shape as in the figure at B or C. The end A will be sprung into shape when tightened from below by the nut D. The lock nut E will hold things permanently.

Contributed by FREDERICK J. SCHLINK.

A CONVENIENT LIGHTNING GROUND SWITCH.

"In cases where the aerial is—permanently and effectively grounded at all times when the station is not in operation, by a conductor not smaller than No. 1 B. & S. gauge copper wire, run in a direct line as possible to water pipe at a point on the street side of all connections to said water

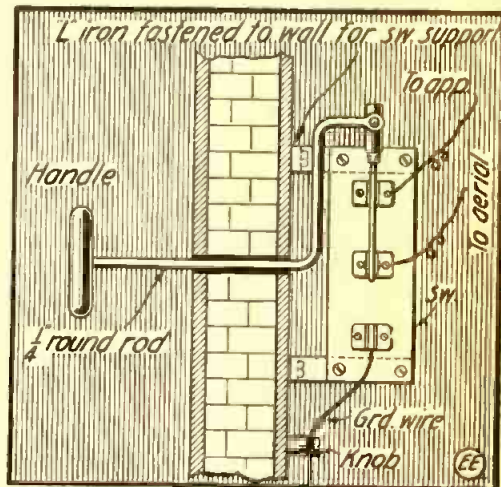

Controlling Out-Door Lightning Switch From Inside of Building.

pipe within the premises, or to some other satisfactory earth connection—the switch to join the aerial to the ground connection shall not be smaller than a standard 100-ampere knife switch."—From sections a and d of Rule 86 of "Rules and Requirements" of the National Board of Fire Underwriters."

Some radio amateurs are not aware of the above fact and others are sadly so because the location of the ground switch often indirectly locates the apparatus in a place which is not as well suited for it as some other. To move the apparatus away from the lightning switch often increases the wave length, so that to keep within 200 meters the amateur must shorten his aerial or use the ineffective series condenser.

The only things required besides the switch are two iron angles, about two feet of one-quarter inch round iron rod, a round wood radiator valve handle and a few screws and bolts. Nearly all of these can be obtained from any hardware store.

A hole large enough to allow the iron shaft to freely turn is drilled in the side of the house and the shaft put through the hole and bent so that the end can be screwed to the switch handle. The location of these screw holes is then found by placing the switch upon the angles with the hinge screw in front of the hole in the wall.

After drilling the holes and fastening the rod to the switch handle the shaft is then put through the hole and the switch screwed fast, as shown. The control handle is then fastened to the inside end of the shaft with a screw or pin and a small indicator put on. It may be necessary to loosen the hinge screw to have freer motion, and the switch should be housed from the weather.

Contributed by FRANK H. BROOME.

Laboratory Equipment for Illustrating the Principles of Electro-Magnetic, Magnetic, and Electro-Dynamic Phenomena

By Harlan A. Eveleth

THE amateur radio-telegraph operator and electrical experimenter enthusiast does not usually obtain satisfaction by the mere operating of finished apparatus which has come direct to his hands from the display windows of the warehouse; he is—to be successful—of an inquisitive temperament and is forever delving into the mysteries of the unknown in the fervent hope of discovering, by the "cut and try" method, some idea which may have escaped the observation of his contemporary "scientists." Following is a description of apparatus which, because of their simplicity and wide range of adaptability, will enable its possessor to investi-

core, one inch in diameter by nine inches in length, is composed of a bundle of annealed, soft-iron wires. It is taped for insulation and then, beginning at a distance of one inch from one of the ends, is wound with six layers, 150 turns to a layer, of No. 20 S.C.C. copper wire. The magnet is to be operated direct from the 110-volt, A.C. 60-cycle mains. It is suggested that empire cloth or other insulating fabric be interposed between the various layers, and that the final layer be taped to prevent abrasion of the insulation.

The magnet should be suspended vertically from a bracket fastened to the wall of the room, and a means must be devised for attaching the cord, by which it hangs, to the upper end of the core. A simple way of doing this is to turn a cylinder of wood to a diameter of about four inches and a length of three inches. Bore a hole at the center of one end of the cylinder to a depth of one inch, and of a diameter which is slightly greater than that of the taped end of the core. Spread glue over the taped core and then force it into the hole in the cylinder and secure it by wooden wedges driven in about its circumference; when the glue has set the cylinder will be securely fastened to the magnet. The whole can now be suspended from the bracket by a stout cord tied to a screw-eye set in the upper part of the cylinder. A switch of some sort should be inserted in the circuit, and it may well be placed on the top of the cylinder near the screw-eye. The feed wires may be entwined about the cord and bracket and then led to the power mains. The consumption of current will vary according to the load placed upon the magnet, but the greater part of the experiments will require but a fraction of a kilowatt.

EXPERIMENT No. 1.—To illustrate electro-magnetic repulsion of an A.C. magnet pole.

If possible obtain a solid copper ring of two inches internal diameter and three-quarters to one square inch sectional diameter; see Fig. 2. A satisfactory ring can be constructed by forming a coil of bare copper wire; wind the coil to the dimensions specified and bind by winding the last few feet radially. A ring formed in this manner by the writer was wound with No. 14 bare copper wire and weighed 1½ pounds.

Steady the magnet with one hand and with the other grasp the copper ring and raise it vertically over the magnet. The electro-magnetic repulsion is so great that

EXPERIMENT No. 2.—To illustrate the heating effect of Foucault or "eddy" currents.

Grasp the ring with a pair of tongs and hold forcibly at a point of maximum repulsion. The ring, notwithstanding its large cross-sectional area, will heat rapidly

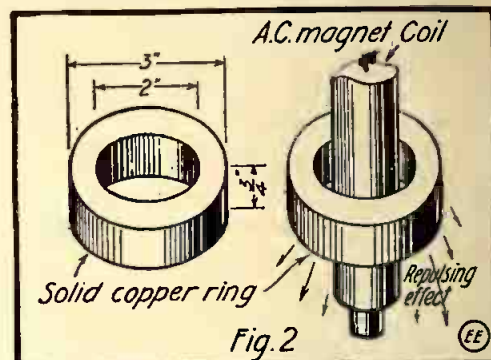

Fig. 2. Demonstrating Repulsion of Solid Copper Ring from A. C. Magnet Pole.

and if left long enough will become red-hot. Care should be exercised so as not to char the insulation of the magnet winding. Lumps of solid iron attracted to the core will heat perceptibly, thus showing the necessity of employing laminated cores in alternating current machinery.

EXPERIMENT No. 3.—To illustrate continuous rotation from electro-magnetic repulsion, or electro-magnetic attraction.

Wind a coil of wire on a form, or "pie," having an internal diameter of 2¼ inches, an external diameter of 5¼ inches and a width of ¾ inch; the rectangular cross-section of the coil will thus measure ¾ inch by 1½ inches. About two pounds of No. 26 S.C.C. copper wire will be required. Tape or bind with cord to preserve its form.

Procure two aluminum discs, 6 inches in diameter and of ⅛ inch gauge. Drill a small hole in the center of each and pivot so they will revolve in a horizontal plane with little friction.

Energize the magnet; then hold the discs,

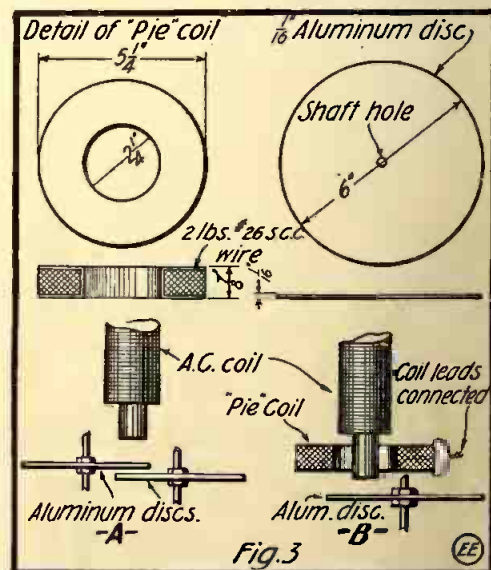

Fig. 3. Apparatus Used in A. C. Rotating Disc Experiment.

partially over-lapping, one about half an inch below the other, Fig. 3 A, beneath the magnet in such a position that the end of the core is above a point on the upper disc, which is about 1½ inches back of one of the two intersections of the peripheries of the discs. The discs will rotate in oppo-

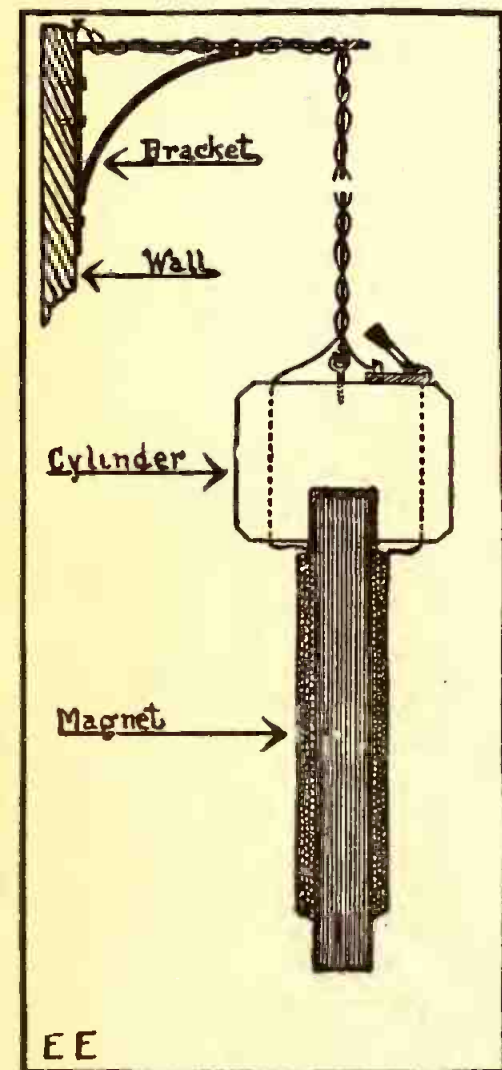

Fig. 1. Showing Suspension of Experimental Alternating Current Electro-Magnet.

gate, to a marked extent, the principles of electro-magnetic, magnetic and electro-dynamic phenomena. Several of the experiments described are exceedingly simple as viewed by the initiated, but all are guaranteed to hold the attention of the uninitiated—the casual visitor to the "laboratory."

site directions. If one disc is held the other will rotate with greater torque.

The rotation of one of the discs can be shown more lucidly by employing the coil of wire, see Fig. 3 B. Slip the coil over the core (it being understood that the magnet is hanging vertically in this experiment) until the bottom of the coil and end of the core are in the same plane, then hold the disc so that about three-quarters of its surface is beneath that of the coil. The disc will rotate in an opposite direction—if held in the same relative position to the magnet—to that of the first case, and will attain a speed of approximately 300 r.p.m. The terminals of the coil should be short-circuited.

EXPERIMENT No. 4.—To show the shape and intensity of the magnetic field around an A.C. bar magnet.

Form a coil of 50 turns of No. 20 S.C.C. copper wire and connect terminals to a discarded telephone receiver, as in Fig. 4. Do not use radio-telegraph receivers which are valued as such, for a strong alternating current is to be induced in the coil, which tends to weaken the permanent mag-

Ingenious Instruments for Testing Electrical Machinery

A new *field tester*, shown in the illustration, Fig. 1, has been perfected for the special purpose of testing the field coils and armatures of the electric railway type of motors. It is a quick and certain detector of weak fields and faults in armatures. It tests the fields when in the motors or out, as the presence of iron makes no difference. It is not even necessary to disconnect the fields. Armatures are tested for shorts, opens and grounds without raising the leads or disturbing the hoods. This new field tester is very simple and easy to operate. It is operated by direct current from the lighting circuits by simply attaching same to a lamp socket in the car or shop.

When testing fields the readings are obtained by sliding the pointer knob along the scale to the point where two distinctly separate sounds become as one, or continuous. The armature test is a bar-to-bar receiver test with the telephone receiver and contact fork.

Experience shows that weak fields are the cause of roasted armature coils, blistered commutators, flash-overs, sparking brushes, arcing controllers, overloaded power circuits and generators. Hence the value of a good field tester, and especially one such as this, which is capable of accurately testing the field coils when in position on the pole pieces.

Another *field and armature tester*, as seen at Fig. 2, is about to be put on the market by the same company. This instrument was developed to supply the demand for testing apparatus that could be operated by current from alternating circuits and which could be used in noisy places, where too much noise might interfere with the use of a telephone receiver. It does the same work as the field tester above described, but instead of the telephone receiver for obtaining the readings meters with pointer and dial are used. When testing field coils the readings are obtained by sliding the pointer along the scale until both meters read the same. The armature test is a bar-to-bar meter test. The meter is mounted in a convenient position right on the testing fork.

The same concern also supplies an *armature tester*, as shown in the accompanying cut, which was developed to supply the demand for a very simple little device intended for testing armatures only. It is operated in connection with either alternating current or direct current lighting circuits. A hard rubber knob with knurled edge permits changing over from one kind of current to the other. As is the case with the two instruments above described, no batteries are used. It quickly detects and exactly locates shorts, opens and grounds without disconnecting the leads or tearing off the hoods. It exactly locates a grounded bar

or coil in less time than it takes to tell about it. It will make a complete test of any ordinary armature in less than two

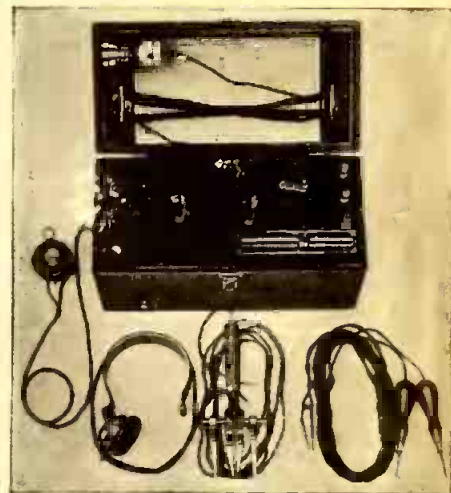

Fig. 1. Instrument for Rapid Testing of Motor and Dynamo Field and Armature Coils.

minutes. This device is regularly furnished with either the alternating current or direct current adjustable contact fork, or both, as desired. It is a handy and indispensable device for power plants and



Fig. 2. Similar Device to That Shown at Fig. 1, but Utilizes Meters Instead of Telephone Receivers.

electrical repair shops of every description. It will test any type of motor or dynamo armature.

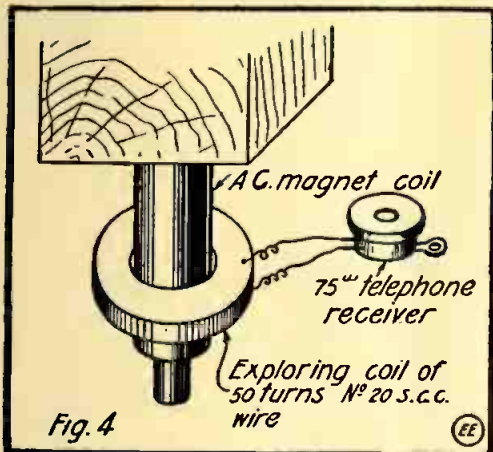

Fig. 4. Exploring Coil and Telephone Receiver for Ascertaining Shape of A. C. Magnetic Field.

net. The magnetic field surrounding the alternating current magnet can be explored and its shape and intensity roughly determined by noting the strength of sound which comes from the receiver as the coil is moved about the magnet. The coil should be kept in a horizontal plane throughout the experiment.

Another method is to employ the coil used in Experiment No. 3, with its terminals connected to a 110-volt lamp. Care should be taken not to burn the lamp out. The induced current from this coil can also be taken through the body without discomfort.

EXPERIMENT No. 5.—To illustrate the principles of the transformer.

Two coils should be wound which will slip easily over the magnet; the first of 10 turns of No. 4 bare, copper wire, and the second of a great many turns of fine, insulated, copper wire. The current induced in the first coil will be in the order of several hundred amperes and the carrying capacity of different sizes of wire can be shown by bringing them across its terminals. Relatively high voltages can be obtained with the second coil; in fact, the whole will act as a fairly efficient transformer.

EXPERIMENT No. 6.—To illustrate the magnetic effects of an A.C. magnet pole upon different metals.

Obtain strips of iron, lead, copper and aluminum and place each in turn beneath the pole of the magnet. The iron will be attracted while the other metals will be slightly repelled. Substances which are attracted to the poles of magnets are termed

paramagnetic, while those which are repelled are termed *diamagnetic*.

Place the pole of the magnet within a box of iron brads, then remove the box from its contents. The brads will tend to align themselves in the direction of the magnetic lines of force. Iron filings may be used if desired, but brads are much easier to pick out of the carpet. Take several of the brads and place them end on end at different points on the magnet. They will form magnetic chains and will tend to assume the direction of the lines of force.

Interpose sheets of glass, aluminum, copper and iron between the pole of the magnet and a *paramagnetic* metal held within

the influence of the field. The sheet of iron will shield the object from the effect of the magnet while the sheets of *diamagnetic* substances will not affect the transmission of force from one point to another, any more than an equivalent thickness of air.

Magnetization may be destroyed or weakened by an excessive rise of temperature. If an iron wire be heated to redness and held beneath the pole of the magnet there will be no attraction between the two. At a temperature of 750 degs. C., known as the critical temperature, iron becomes non-magnetic, but upon cooling it becomes magnetic although completely demagnetized at this stage.

THE CONSTRUCTOR



How to Make an Electrolytic Rectifier

By C. R. Barmckol

The following are the details for the construction of an electrolytic rectifier for the experimenter who does not want the

will be found very satisfactory. The ends of the box, at the top, are cut down 1½ inches, making U-shaped ends for the top

Having procured the plates, they must next be put in place. Their position may be seen in the drawing, the large iron plate being the central plate of the middle jar. The top board is measured off as shown in drawing, the first slot (all slots ½x¼ inch) being placed 1¼ inches from edge. One-quarter inch separates this from the next slot, and the drawings give dimensions for the remainder.

Having slotted the board, the plates are then fitted in their position as shown. After fitting them up as tight to the supporting board as is possible, bend the plates over as indicated. This serves to hold them in place. Binding posts from ordinary dry cells can be used, and are placed in the holes drilled in the plates. Having finished this part, mount other binding posts, two for alternating current side and two for direct current side on the board, and connect as shown in drawing. Next mount the rheostat on the end of the box where the cover extends over. It will be seen that by cutting down into the box the lugs of the plates are protected. Next paraffine the inside of the box. The fruit jars are placed in it as shown. The solution is to be made as follows: Fill jars within ¼ inch of top with water. (Warm water is better, but not necessary); then dissolve a heaping teaspoonful of ordinary baking soda into each jar of water. Then to each jar very slowly add about three or four teaspoonfuls of sulphuric acid. Although this solution can be used immediately, it is better to allow it to cool for some time.

The rectifier will be found quite efficient, and its small size makes it very desirable. An ammeter may also be mounted on the side of the box in the case of charging storage batteries. Also another improvement may be added. You may cut a rectangular hole in one side of the box, thus making it an open window rectifier, allowing inspection of the jars without removal. To take out plates and to renew solution only the wire to the rheostat needs to be disconnected. This rectifier utilizes both halves of the cycle.

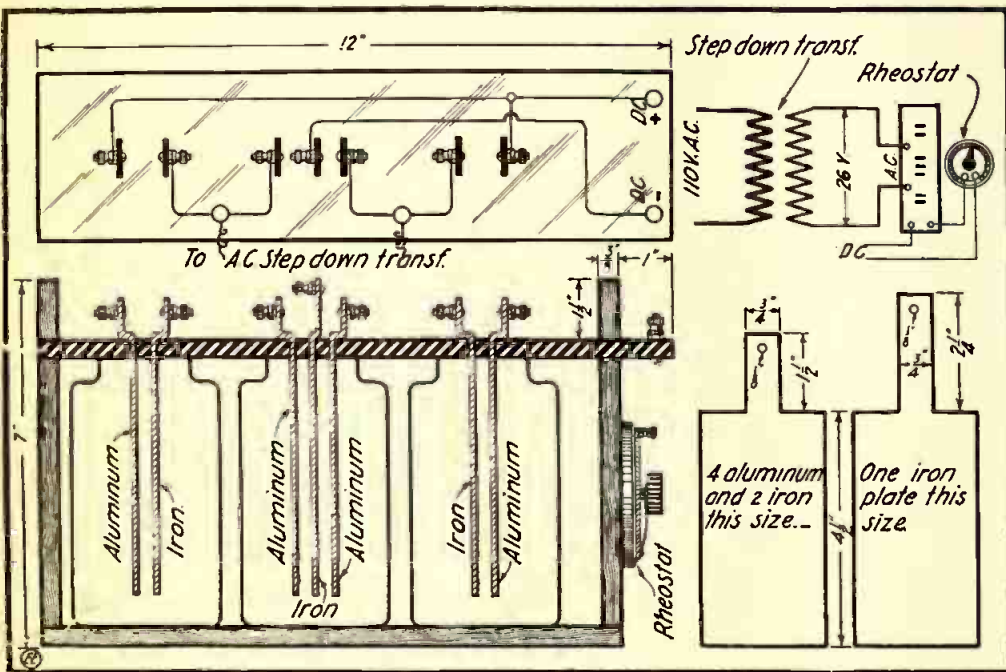

Parts for Making an Electrolytic Rectifier.

trouble of dragging numerous large jars about and who does not care to spend much money. If you have a few things around the house the cost is insignificant as compared with the larger rectifiers.

With an alternating current pressure of 26 volts from the secondary of a step-down transformer the rectifier has given as high as 6½ amperes. Of course, it cannot be used for any great length of time owing to its size, but I have recharged storage batteries very successfully by charging at intervals.

The first thing to build is the containing box. The wood should be about ¾ inch thick, with the following dimensions: 11x7x4¼ inches. A Mellin's Food box

of box. In these slots, where the box has been cut out, the board holding the plates rests. Its dimensions are 12x3½ inches. The containing jars are three ordinary one-pint fruit jars. The next part is the plates. Aluminum and iron are used. The necessary plates are drilled and cut as follows:

Four aluminum plates 4½x2 inches, with lugs 1½x¼, drilled for ⅛ hole, ½ inch from top.

Two iron plates 4½x2 inches, with lugs 1½x¼, drilled for ⅛ hole, ½ inch from top.

One iron plate 4½x2 inches, with lugs 2¼x¼ inches, drilled for ⅛ hole, ½ inch from top.

to the post grounded to the bell frame and the other to the adjusting screw on the make and break contact, I secured excellent results. The batteries are connected to the bell as usual. Contributed by JEAN J. EILER.

MAKING A LOW VOLTAGE LAMP.

Procure an ordinary mazda lamp (110, 115 or 120 volt), the vacuum of which has not been impaired. This lamp may have been broken by rough handling or burned out normally. Then connect a socket (which can be placed in any position) to the current supply and screw in the lamp. Tap the lamp so that all or part of the filament comes loose from the wire support. Now shake the lamp around, so that the filament falls across the two lead-in

wires. The lamp will light up as soon as contact is made within the lamp.

If the lead-in wires are far apart, the lamp will burn best on 6 volts or more; but if the lead-in wires are very near or the filament extra thick, the lamp will light best on a lower voltage, as 2, 3, 4 or 5 volts.

The writer has had success with about 95 per cent. of all the lamps thus tried. These lamps burn up to 800 hours when filament is new, and from 25 to 200 hours when filament has already been used.

Contributed by EPHRAIM DUSKIS.

Liquid Polish.—Kieselguhr, 7 lb.; Bath Brick (powdered), 3 lb.; Oil of Lemon, 2 oz.; Lemon Juice, 1 gal.; Paraffine Oil, 1 gal.; Malt Vinegar, 4 gal.

EMERGENCY SPARK COIL VIBRATOR.

Having need for a spark coil vibrator.

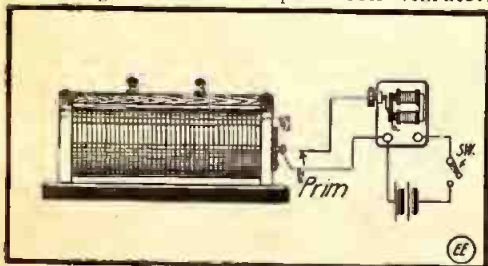

Using Ordinary Buzzer as Spark Coil Interrupter.

and no time to construct one, I hit upon the following idea: Taking an ordinary door-bell and connecting one primary wire

A PERMANENT MAGNET TYPE VOLTMETER.

Herewith I suggest how to construct a permanent magnet type voltmeter, which I have made myself and found to work very satisfactorily.

The case (at Fig. 1) is made of any suitable wood that is not too thick. The base of the meter is $5 \times 7\frac{1}{2} \times \frac{1}{4}$ inches, while the front part of the case is $5 \times 7 \times \frac{1}{4}$ inches, with an egg-shaped hole $3\frac{1}{2} \times 2\frac{1}{4}$ inches

inch from the top, which forms the front bearing. The rear bearing, as shown in Fig. 7, is built from a flat piece of a brass door-catch with two perforations bored through it for screws, with a punch mark at the center for the needle point of the armature.

No. 36 wire is wound around the armature, through the slots, after first soldering one end to a needle point. About 150 turns are taken, after which the other end is

spread over the zinc and give it the aspect of a looking-glass. A piece of wire may be soldered to the zinc (before amalgamating it) in order to attach the mold thereto. In the porous cup is to be placed a solution of dilute sulphuric-acid, made by stirring one (1) part of sulphuric acid in ten (10) of water. The water must not be added to the acid, or the violent reaction might cause an accident with serious result. A saturated solution of copper sulphate, or blue vitrol, is to be placed in the vessel containing the porous cup. The solution must be kept saturated with the copper-salts. This can be done by placing a small basket made of wire screen in the solution and keeping it partly filled with the copper sulphate. The basket must be hung near the top of the vessel in order that the solution may be diffused equally through the water.

The mold is then to be made. Anything that will take the fine lines of an engraving can be used. Gutta-percha and wax are the commonest materials now in use for this purpose. The wax must be warmed and worked into a ball and then pressed over the coin, Gutta-percha must be scalded. The coin should be slightly oiled before pressing on the wax, so as to prevent sticking. A small wire must be pressed in on one side of the wax (near the face of the coin) as in top sketch. The mold should be brushed over with powdered black lead (graphite) and polished. Some of the lead must be placed on the wire so as to conduct the electric current. When all is ready fasten the mold to the zinc-rod and place it so it is in the copper-sulphate solution. After leaving it about 12 hours the exact reproduction, or rather impression of the mold will be reproduced in the copper. This can be pried off the wax and the mold used again. The impression may be coated with a thin film of solder on the back by rubbing it over with the soldering fluid, and then by placing a few small pieces of solder on it. A soldering iron should be utilized to melt the solder. In the drawing the various parts of the outfit, designated by letters, are thus explained: A is the mold, B is the containing vessel, C is the porous pot, D is the zinc, and, finally, E is the little wire basket, suspended on wire from the top of the vessel, as clearly shown. When not in use the outfit may be used as an ordi-

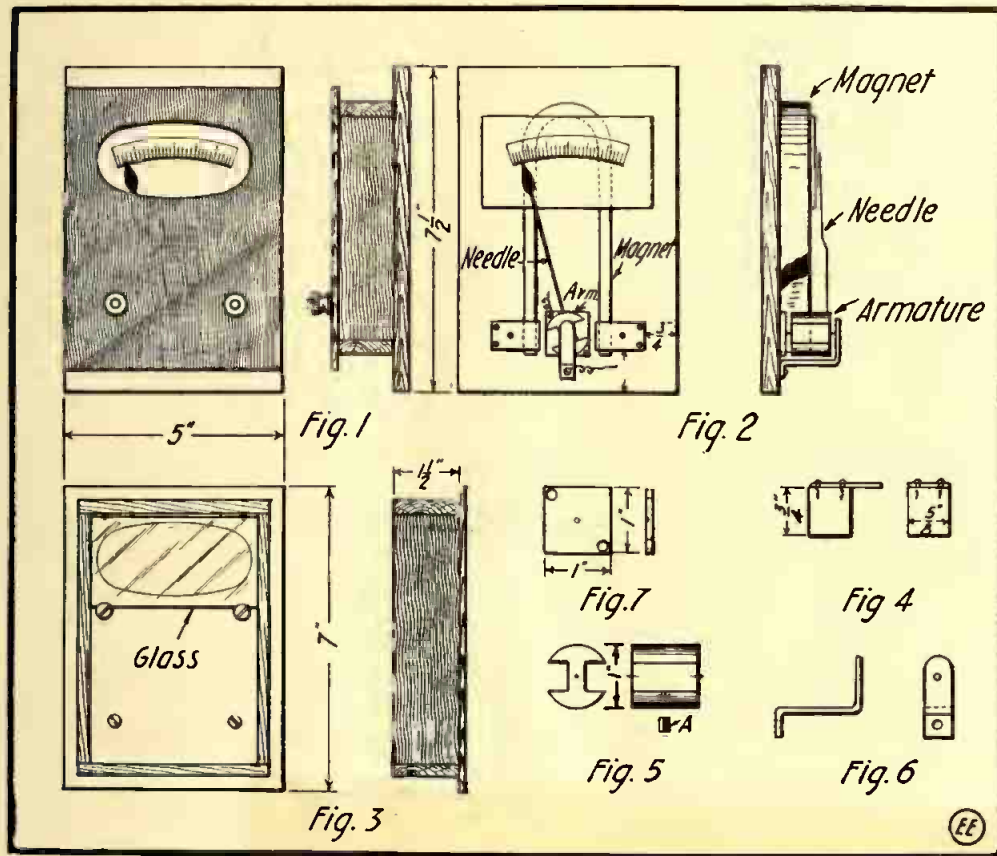

Details and Make-up of Permanent Magnet Style Voltmeter.

cut into it for the glass. The sides of the case are $1\frac{1}{2} \times 6 \times \frac{1}{4}$ inches. Two holes $2\frac{1}{2}$ inches from the bottom are drilled for binding posts, and a piece of glass is cut and fastened on inside of the case, as shown in Fig. 3, by four tacks. The scale is of cardboard glued to the horseshoe magnet, which is in this case taken from a telephone magneto.

The steel magnet is supported at the top by a strap as shown. This strap is either screwed or glued fast to the base. The side supports are two blocks, with strips of wood tacked or glued on so that they overlap (see Fig. 4). The side supports are fastened to the base in the same manner as the upper block. A wooden block turned into a cylinder, with a groove sawed on each side lengthwise for winding the wire in, constitutes the armature. A portion of a sewing needle is forced into each end, leaving the points projecting to form the shaft of the armature. A hole $\frac{3}{16}$ inch in diameter is bored into the bottom of the block, into which a small lead weight A is placed for the purpose of bringing back the armature to normal position after it has swung over, due to an electric charge. Into the top of the armature a straight-pointed aluminum or brass wire $3\frac{1}{2}$ inches long is forced. This serves as the indicating needle.

The front bearing is a piece of strip brass $2\frac{1}{4}$ inches long, bent as shown in Fig. 6. First $\frac{1}{4}$ inch is measured off and bent; then it is bent again 1 inch from the first angle, leaving $\frac{1}{2}$ inch for screwing on to the base. A deep center-punch mark is made in the vertical leg of the strip $\frac{3}{16}$

soldered to the remaining needle. Wires are attached to the screws that hold the bearings and then to the binding posts on the case, after which the case is screwed on by two round-head wood screws. The scale is of pasteboard, glued on to the magnet as shown. If the needle does not move correctly after connecting the instrument to a battery, remove the wires and thus reverse the polarity of the circuit.

To calibrate the instrument, connect it up to one dry cell and indicate where the needle comes to rest by a pencil mark. Then connect it up to two cells; then three, and so on until the needle is at the end of the scale. The first mark signifies $1\frac{1}{2}$ volts; the second 3 volts, and the third $4\frac{1}{2}$ volts, etc. After the marks are numbered the scale can be divided off into fractions of a volt fairly accurately.

Contributed by

EARLE BELSINGER.

A SIMPLE, YET EFFICIENT ELECTROPLATING APPARATUS.

A novel, interesting, yet inexpensive electroplating outfit may be readily constructed from odd parts, usually to be found in an experimenter's laboratory.

A wide-mouthed jar, of about one (1) quart capacity, will serve for the cell. In this cell is placed a porous cup, which may be taken from an old battery. A rod or strip of zinc is now to be placed in the porous cup and the zinc must be amalgamated by rubbing its surface, previously polished, with dilute sulphuric acid and then with mercury. The mercury will

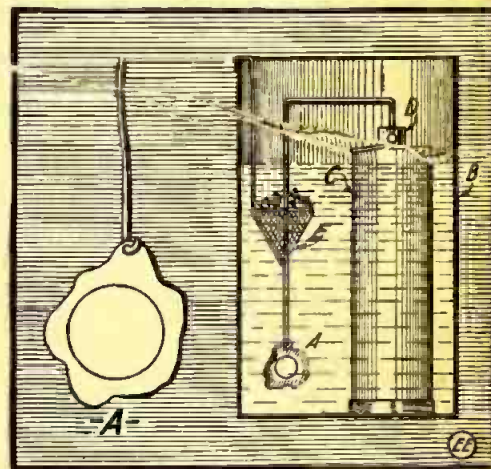

Home-made Electroplating Set.

be used for ringing door-bells, etc. by placing a piece of copper bent in a circle around the porous pot.

The most pleasing and satisfactory results and experiments can be carried out if the directions are carefully and exactly followed. Contributed by

WM. WARNECKE, JR.

A HOME-MADE MERCURY VAPOR LAMP.

A mercury vapor lamp may be easily constructed by any experimenter with the aid of a very simple apparatus, by making use of the principle of a Torricellian, or barometer vacuum. The above vacuum is produced when a long tube is closed at one end, completely filled with a liquid and then inverted with its open end under the

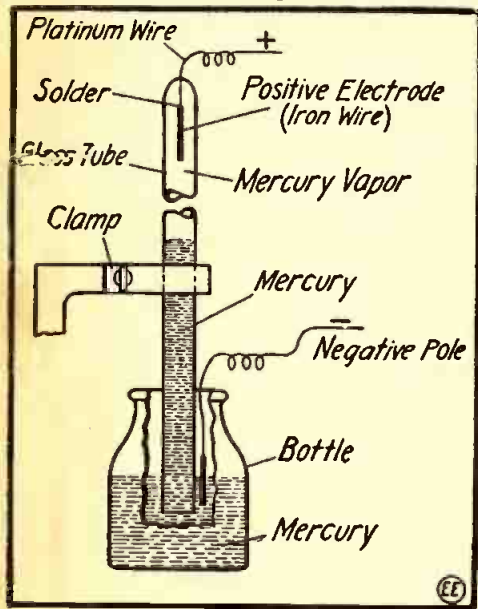

Home-made Mercury Vapor Lamp.

surface of more of the same liquid, as the illustration shows. Under these conditions the liquid, if the tube be long enough, will fall to a certain height above the lower liquid level. The space above the liquid is left empty, except for the small amount of liquid which evaporates into it, existing as vapor.

Mercury vapor lamps consist essentially of a positive electrode of iron and a negative electrode of mercury, projecting into a vacuum saturated with mercury vapor. Minor details as to the means of starting may be omitted here for the sake of brevity. This vapor, under certain conditions, is capable of carrying a current of electricity, at the same time becoming heated and producing a dazzling, bluish-white light.

The mercury vapor lamp is made as follows:

Procure a glass tube about 40 inches long, of about 1/4-inch bore, with medium thick walls and open at both ends. By heating very carefully and gradually, first in the smoky flame and then in the bluish flame of a gas or kerosene torch, the walls become softened, so that they will close together around a piece of platinum wire twisted to a piece of No. 12 iron wire, thus sealing it into the tube.

Fill the tube thus prepared with some pure mercury, which has been boiled to remove all of the inclosed and dissolved air. This boiling should take place in a glass or porcelain vessel. The resulting fumes, which are very poisonous, should not be inhaled.

The glass tube must be wholly and completely filled with mercury. Not even a bubble of air should be left behind, sticking to the walls; otherwise the operation will be a decided failure. When absolutely sure that all the air has been removed, close the open end of the tube with the thumb, and by inverting it place this end under the surface of some mercury in an open vessel. Then, while still under the surface, remove the thumb.

This done, the column of mercury will not completely fill the tube, but will fall to a height of about 29 inches. In falling from the top of the tube, since there was

no air present, it might be supposed that there would be a space quite empty left above the mercury. This is very nearly, but not exactly, true, as the mercury, like water, only to a much smaller extent, will evaporate, thus filling the space above it with attenuated mercury vapor.

Clamp the tube in a vertical position and attach one terminal to the mercury in the dish by merely inserting a wire in it and the other to the iron wire electrode terminal projecting from the top. The current used may be 110 volts direct current, taken from the street mains, or from any other convenient source.

When the power is first thrown on, no current will flow because of the very high resistance of the space between the electrodes. If a spark from an inch or even 1/2-inch spark coil be sent across the terminals, it will break down this high resistance and pass. In doing so it will cause the formation of much more mercury vapor than before, on account of the resulting heat. The path of this spark will then have much less resistance than the space had before, on account of the greatly increased amount of vapor present. Because of this lowered resistance the main current is now able to pass, and in doing so will heat the vapor in its path to a bluish-white, dazzling light, with which the reader is familiar. Contributed by

ALFRED MORGENBOLD.

HOW TO BUILD AN OZONE GENERATOR.

The peculiar properties of ozone as a purifier and sterilizer have made it very serviceable for use in libraries, homes, factories, etc. An apparatus to produce ozone, termed Ozonator, can be readily made and advantageously employed.

This generator should be made up of three distinct parts—the high-tension induction coil, such as a two-inch spark coil; the discharging device and the circulating fan. These are treated in the following paragraphs.

An ordinary spark coil, having heavy contact points, in order to stand continuous work, and better still, if used on 110-volt alternating current, with its vibrator closed and in series with a suitable resistance, should be employed. If direct current is available an electrolytic interrupter should be placed in a vessel containing some water, or, still better, circulating water, so as to cool the solution of the interrupter. This latter method of running the coil will be found very satisfactory. It can be connected in the usual way.

The discharging device is next to be con-

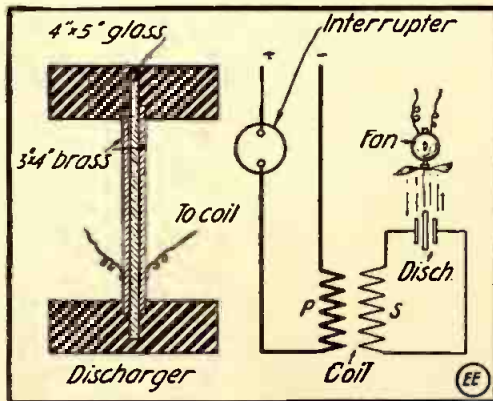

Details of Ozone Generator.

sidered. To ozonize air it is essential that a visible electrical corona or brush discharge be produced. This takes the form of a violet glow and is always the index of an extremely high potential or voltage.

There have been many forms of dischargers developed, among which the one herein treated is quite efficient and, more-

AUTOMATIC LIGHTING SWITCH.

How many times have you entered a dark room with your hands full and found to your great perturbation that to turn the light on you would have to drop everything, thus losing time and also patience? To alleviate this, the following may aid you to lose less of your patience and also to retain your good nature:

Remove the switch and place it in such a position that it will be behind the door

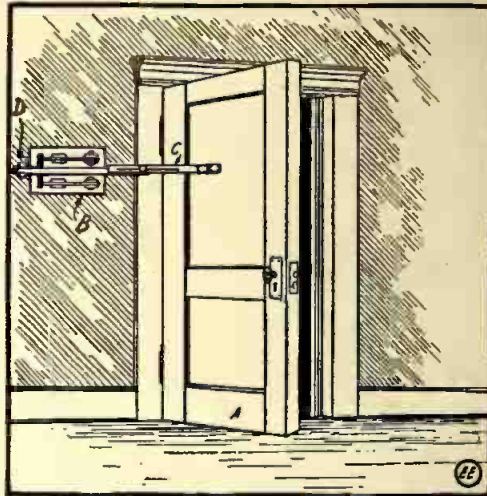

Switch Fastened to Door by Rod "C" Cuts Off Lights Automatically.

when opened. Then procure a piece of wood (use your own judgment in selecting); also another piece about 4 inches by 3/4 inch, and join these pieces as shown in diagram, nailing crosspiece to door. Now bore a hole through the handle of the switch and also in the stick nailed to the crosspiece. Put an axel from an old skate wheel through the holes and fasten them by an ordinary machine pin. Now the opening and closing of the door will turn the switch automatically on and off.

Contributed by ANDREW M. GALLAGHER.

over, simple in construction. Two pieces of heavy sheet brass, measuring 3x4 inches, are placed in a horizontal position, one-eighth inch apart, in grooves in a fiber base. Rubber should not be used, as it carbonizes quickly under such electric stresses as it would be subjected to, and wood has too low a dielectric strength. Between the brass pieces in another groove, at least one-quarter of an inch deep, should be fitted a one-eighth-inch sheet of plate glass, measuring 4x5 inches. The difference in potential of the two electrodes, which are connected to the secondary terminals of the coil, is sufficient to cause a violet "brush" or corona discharge to form in the spaces between them and the dielectric. In these spaces enough ozonized air is produced in a short while to purify and freshen the air in a comparatively large room or hall.

The function of renewing the air between the electrodes and forcing the ozonized product out into the room is performed by a small electric fan, operated either by storage batteries or on a lighting circuit. It should be placed several inches behind the discharger, so that the air flows through the electrodes and out into the room.

The complete ozone generator may be mounted or cased, as the builder desires. The different parts are connected in the manner shown in diagram.

Contributed by WILLIAM AMPERE.

[Ed.—It is usual to employ a small 75 to 100 watt alternating current step-up closed core transformer for this purpose. One giving about 7,000 volts at the secondary is used in several commercial ozonators of small type.]

HOW TO MAKE IT



This department will award the following monthly prizes: **FIRST PRIZE, \$3.00; SECOND PRIZE, \$2.00; THIRD PRIZE, \$1.00.** The idea of this department is to accomplish new things with old apparatus or old material, and for the most useful, practical and original idea submitted to the Editors of this department, a monthly series of prizes will be awarded. For the best ideas submitted a prize of \$3.00 will be given; for the second best idea a \$2.00 prize, and for the third best a prize of \$1.00. The article need not be very elaborate, and rough sketches are sufficient. We will make the mechanical drawings.

FIRST PRIZE \$3.00.

A USEFUL 495 WATT ELECTRIC STOVE.

The enclosed drawing shows a simple way of making an excellent electric stove for use on a circuit of 110 volts at 4.5 amperes. This stove will be interesting

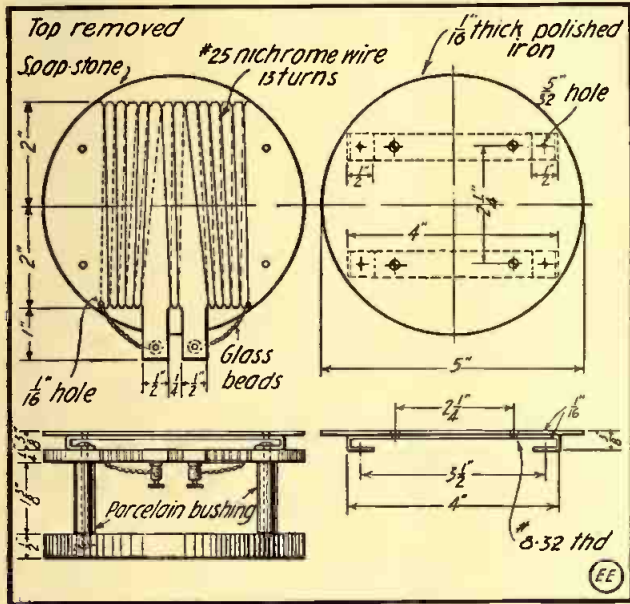

Practical and Useful Home-made Electric Stove.

for those who like simple designs.

The heating element is made from asbestos or soapstone; either one will do, as it is easily cut with a hack saw. Then it is wound with No. 25 Nichrome wire (9½ feet in all). After it is wound a few beads are slipped on the ends, so as to insulate them from outside objects, and fastened by means of binding posts.

The unit is supported by four screws running through porcelain bushings and fastened to a slate base. When this is done a cover is cut from 1/8-inch thick iron and fastened to the screws. This will be useful for heating the coffee pot, etc.

Contributed by **FRANK HARAZIM.**

AN ACID-PROOF CEMENT.

A very good acid-proof cement for cementing articles exposed to acids may be made up of a mixture of litharge (yellow lead) and glycerine. Mix to a stiff paste and use quickly, as this cement sets quite rapidly.

A Good Varnish for Electrical Apparatus.

A very good insulating varnish for metal work on electrical instruments is black asphaltum varnish. It has a finish like black enamel and good insulating qualities.

If this finish is too glossy a varnish made from orange shellac and lampblack should be satisfactory.

This latter is better for woodwork, while the first is better for metal work. Contributed by **WALTER FRANSEEN.**

SECOND PRIZE \$2.00.

A SIMPLY CONSTRUCTED POLARIZED RELAY.

Many experimenters have found it impossible to use a polarized relay owing to the prohibitive price which is usually charged for this instrument. The following description, together with the accompanying drawing, will enable one to make a simple yet efficient instrument of this character with little trouble:

An alternating current or magneto bell ringer (polarized type) is mounted on a wooden base about 4x8 inches. A hole is drilled through the clapper ball to accommodate a pair of silver or platinum contacts C' and C'' as shown. Adjustable contact screws C and C'' are mounted so as to be engaged by the contacts in the clapper. A spring SP connects the clapper with a rotatable and slidable rod BR, which serves to hold the contacts C' and C'' in a neutral position between the contacts C and C''.

Connections are made as shown by heavy dotted line. Upon the reception of a direct current either one or the other of the circuits will be closed, depending upon the

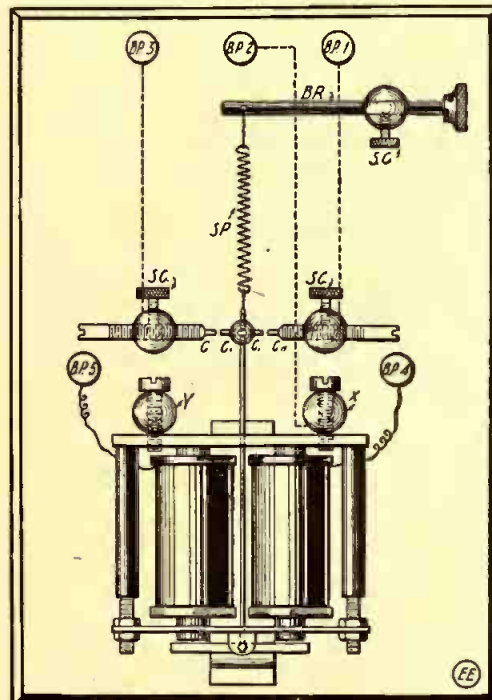

Polarized Relay Constructed from A. C. Telephone Bell.

direction of the current. By the use of this instrument either of two circuits may be closed at will over a two-wire line by

THIRD PRIZE \$1.00.

A MAGNETIC POLARITY INDICATOR.

Magnetic polarity indicators are not very well known to the average experimenter, and the sketch herewith shows a plan for making up one from a pair of 20-ohm electro-magnets and a small permanent steel magnet, properly mounted. While

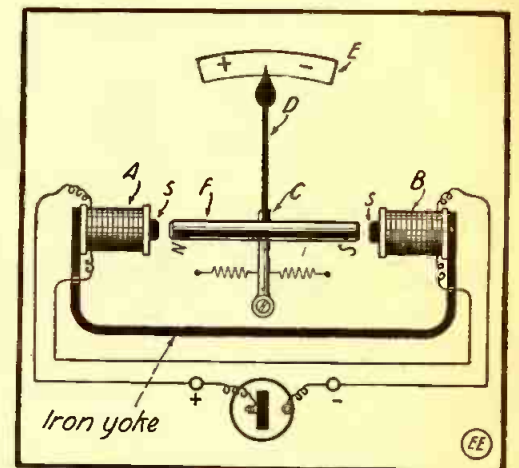

Magnetic Type Polarity Indicator.

one electro-magnet can be used in making up this device as at A, it is best to use two of them as sketch shows. The small permanent magnet, which can be made of a piece of magnetized tool steel about 1 inch long by ¼ by 1/16 inch, is mounted on a pivoted arm C carrying an indicating needle D. A paper scale is mounted suitably on the device, as at E, with a zero center mark. Care must be taken in hooking up the electro-magnets, so that when the positive pole of the circuit is joined to the binding post marked "plus" the proper magnetic poles will be produced in the electro-magnets to give the maximum effect or reaction on the permanent magnet F. This can easily be ascertained by making a couple of tests with different connections from the magnet coils. When two magnet coils are used, mounted on a soft iron yoke (made of ½x½-inch stock) the two core ends facing each other will have to produce the same magnetic poles, so that in one air gap the magnetic action between the permanent magnet and the coil A will be "attractive," while in the opposite air gap, at magnet B, the magnetic effect will be "repulsive." This acts on the principle that like poles repel, while unlike poles attract each other. Contributed by **G. BARENBLATT.**

A dime in time may save nine. A single idea gleaned from these columns may save you money and time going over ground already covered.

means of a key and a simple pole-changing switch. Contributed by **HENRY B. GRAVES, JR.**

FASTENING CONTACT POINTS ONTO ALUMINUM.

Sometimes it is convenient to use aluminum as the moving element on an instrument such as a moving coil relay, or in wireless telegraphy when the element must necessarily have a small time period to prevent lag. These moving elements must have contact points on them, and as it is difficult to solder them onto alumi-

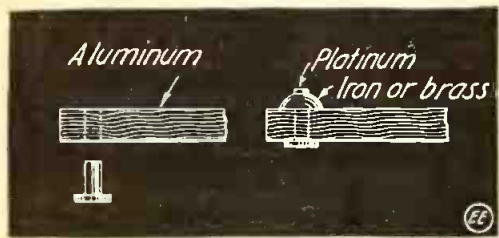

Method of Securing Platinum Point to Aluminum Parts.

num I hereby propose a plan which has proven successful.

A small rivet, made necessarily of light material, such as from lath or shingle nails, can be riveted to the aluminum. Sheet platinum can then be soldered to the nail head, which first must be well cleaned and scraped. This will present a comparatively large and non-oxidizing surface to the spark. By referring to the illustration this will be made very clear. Contributed by R. E. RYBERG.

A HANDY DRY CELL TESTER.

Practically the simplest and most commonly used method in vogue for testing the electrical activity of dry cells is that involving the use of an ordinary buzzer or bell. If any number of cells worth mentioning are to be tested it is rather a tedious job to try out each with two wire terminals from a buzzer. Therefore I provide in this suggestion a very quick and efficient method of testing such batteries, and the sketch makes this idea quite clear.

It consists simply of a piece of wood cut to the shape indicated; on the lower part of it is mounted a small buzzer. The two terminals of the buzzer connect by pieces of copper wire to two copper strips, as shown. All that is necessary is to place the lower part of this wood support between the binding post of the dry cell so that the two copper shoes on same make contact with the zinc and carbon binding posts.

Contributed by MONROE MILAM.

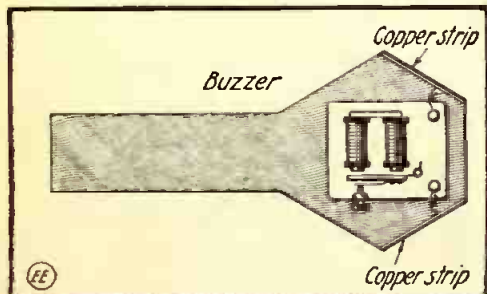

Testing Device for Battery Cells.

A GOOD READING LIGHT.

Have you a good reading light? If this very important question was put to a mass of people 99 per cent. of that mass would be compelled to answer in the negative. Why?

The reason that good lights are so uncommon is not so easy to discover. Perhaps the best explanation may be found in the well-known proclivity of the human mind to accept without question the things it is most familiar with, and to turn to the

unfamiliar and remote in its efforts at improvement. It is only within recent periods that it has been made possible for most every individual to be provided with an artificial light that is practically as good as daylight.

If electric light is used in a dome over the library table the dome should be arranged to take a single Mazda or tungsten lamp, which should be fitted with a prismatic or opal glass reflector, and the lamp itself should be what is called "bowl-frosted," i. e., have the lower part of the lamp frosted. A 60-watt tungsten lamp will give ample light under all ordinary conditions and will use very little more current than a single 16 C. P. carbon filament bulb, which consumes about 54 watts. Desk lights should be fitted with a reflecting, or rather deflecting, shade, to prevent the direct or

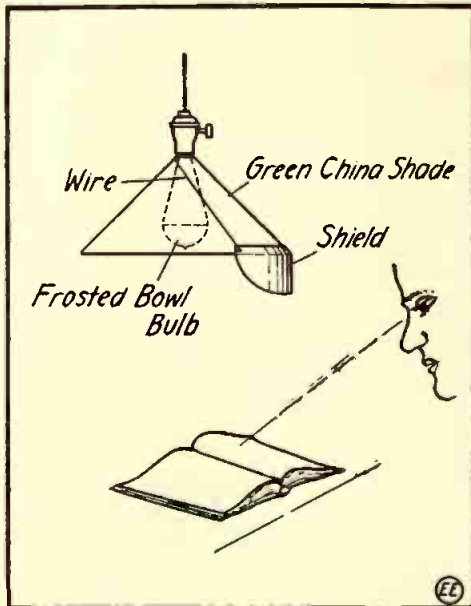

Efficient Desk Lighting Scheme.

even strongly reflected light rays from striking the eye. A sufficient, yet soft, light is that which proves the least trying to the eye. Indirect lighting is widely employed, but is not universally adaptable to all requirements.

A FLASHLIGHT "BULB" PROTECTOR.

Those who are troubled with the crack-

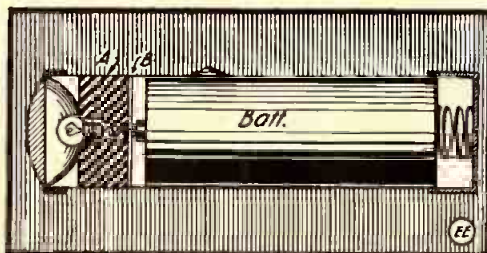

Lamp Protection for Flash-Lights.

ing or breaking of flashlight bulbs and filaments will find the following device an antidote for these unpleasant mishaps:

All that is necessary is a block of either fiber, hard rubber or wood, backed by a copper disc. Through the center of this block is bored a hole, large enough at one end to allow the base of the lamp to fit in with ease. Just below the disc of copper the hole is made smaller, with a small spring attached.

The object is to take the weight of the battery off the lamp bulb and put it on the case instead.

Contributed by WATSON McALEXANDER.

ELECTRIC FAN HELPS DRY PHOTO NEGATIVES.

Those engaged in developing and drying photographic negatives will find an ordinary electric desk fan of great value in quickly drying such negatives as they rest in their drying rack. The fan is placed a few feet

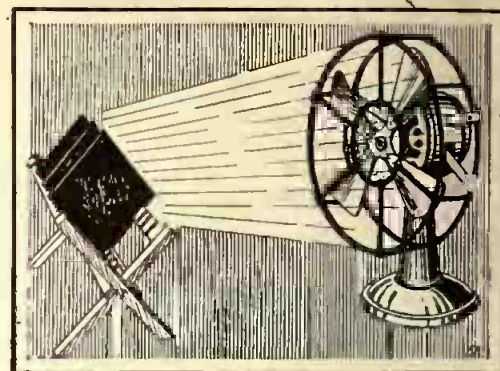

Electric Fan Quickly Dries Photo Negatives.

away from the negatives, and it is best that this arrangement is so located that a good draught of fresh air can be drawn in through the fan from an open window. The negatives will be dried very quickly in this way, and it is considered by many photographers as much superior to the use of artificial cooling baths.

ETCHING ON STEEL.

Cover the article with a film of paraffin wax (or candle grease) and with a scribe write or mark on the surface whatever is required, making sure to cut clean through the wax. Sprinkle some salt over this and then cover with strong nitric acid. The etching should be continued for an hour or so, depending upon the depth of the etched part. Then clean off with hot water and grease the article to prevent any rusting.

Rust Preventive.—The following is a good rust preventive for steel: 16 parts Turpentine and 1 part Caoutchouc dissolved by a gentle heat. To this add 8 parts Boiled Oil, stir and at the same time bring to the boiling point. Apply with a brush after the manner of varnishing. This coating can be removed by the use of Turpentine if desired.

IMPROVED BINDING POST MOUNTING.

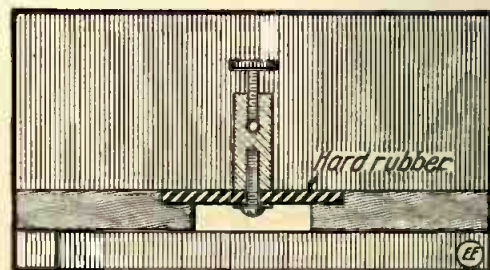

Improved Insulation for Binding Posts.

The sketch herewith shows a method of using 1/8 inch hard rubber (or other thickness) as an insert in table or cabinet tops to support binding posts, spark-gaps, helix stands or other connections which carry high potential or high frequency currents.

This results in better insulation and greater efficiency without the excessive cost of using hard rubber for the entire surface. It is recommended for wireless receiving sets also if maximum efficiency is to be realized from such sets.

Contributed by I. L. JONES.

A BATTERY COMPUTING TABLE.

A convenient table to have at hand for quickly calculating the power of dry cells connected up in various ways is shown in the accompanying illustration. This table

Multiple	Series										Batteries				
	1	2	3	4	5	6	7	8	9	10	1	2	3	4	5
1	1 1/2 V	3 V	4 1/2 V	6 V	7 1/2 V	9 V	10 1/2 V	12 V	13 1/2 V	15 V	1	2	3	4	5
2	30A														
3	40A														
4	60A														
5	80A														
6	100A														
7	120A														
8	140A														
9	160A														
10	180A														
10	200A														

Direct Reading Battery Chart.

is worked out for "new" dry cells only. Each square represents a single dry cell. Should a battery with an output of, say, 6 volts, 60 amperes be desired, then 6 volts are depicted on the top line under the (cell) number 4, signifying that it takes four cells in series to produce 6 volts. Sixty amperes will be found on the side row opposite the figure 3, indicating that three cells in multiple make 60 amperes. Now four cells in series and three rows in multiple ($4 \times 3 = 12$) give 12 cells necessary for the desired output. Also, as each of the 12 squares represents 12 cells, the arrangement can be readily understood.

Any combination up to 15 volts, 200 amperes may be obtained. Contributed by ARTHUR R. DARLING.

A MYSTERIOUS MOUSE WINDOW ATTRACTION.

On the end of the motor shaft, as depicted, a horse-shoe magnet of tungsten steel is attached. This, of course, must be well magnetized. An old, weak one, will not do. Now, on top of the wood box, where the cover was removed, a cloth is fastened, by small tacks, as shown in sketch. Two binding posts may be placed on the side of box, as will be noted. Next a mouse-trap (of circular shape, preferably) is obtained and the entire base thereof removed so as to leave the hollow, wire net only. A little gray mouse (costing but a few cents) of plaster-paris is needed,

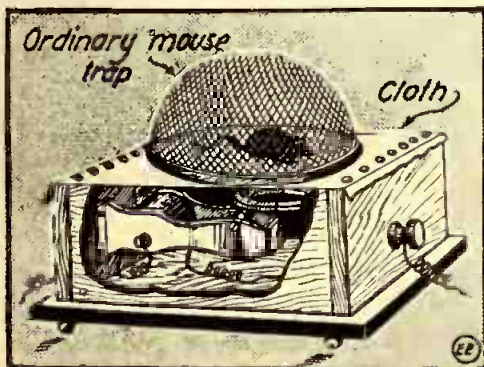

Magnetic Revolving Mouse Window Display.

such as are usually sold in stationery stores, also a piece of iron 1/8 inch thick is tacked to the bottom of the mouse. The base, however, so as not to be noticed, must be neatly trimmed off so as to fit the lines of the little creature. When all is ready the

mouse is placed on the cloth, the wire net placed over the mouse, and the motor set rotating. As the motor turns around the mouse will also hurry around, being attracted by the magnetism of the horse-shoe magnet on the revolving shaft of the motor. It is desirable that the motor should not run too fast. Contributed by WM. WOODHOUSE, JR.

WINDING RESISTANCE COILS.

Many an experimenter has wanted to make a resistance or perhaps an electric toaster or heater but was at a loss as to

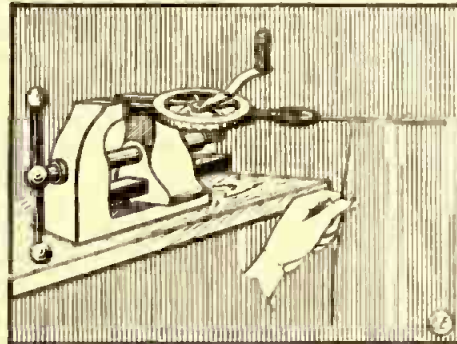

Hand-Drill Used for Rapid Winding of Resistance Coils.

winding the coils of the resistance wire. While making a resistance I hit upon the following method of winding the coils: The handle was removed from a hand drill and the drill fastened in a vise so that the crank could revolve freely. A 3/8-inch rod, 5 inches long and with a 1/8-inch hole in one end, was fastened in the chuck. The wire for winding the coils was No. 22 iron (German silver would do), having been obtained from a basket factory. The wire was cut into as many 9 foot lengths as coils were needed. The end of the wire was put through the hole in the end of the rod and the wire wound on the rod in one closely formed layer. The end of the wire is pulled out of the hole and the coil slipped off the rod. This gives a coil about 4 inches long, but when stretched to about 6 inches in length the adjacent turns do not touch. I wound 120 of these coils in one afternoon, using this method. Contributed by ALBERT P. VANSELOW.

A CHEAP ATTACHMENT PLUG.

Herewith I suggest a method for utilizing

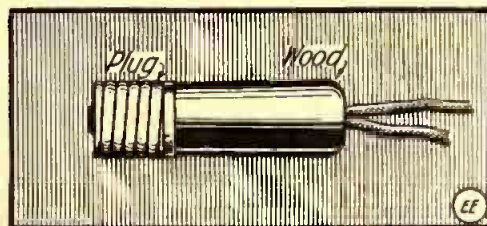

Attachment Plug Made From Wooden Rod and Lamp Base.

to good advantage an old incandescent lamp base and a piece of broomstick.

Empty the lamp base of everything except two wires, which should be threaded through a hole bored in the center of a short stick cut from an old broom handle. The wires are then soldered firmly to a couple of flexible leads. The wooden plug may be cut down until it just fits into the brass cup and with a little glue it can be made to hold fast.

This completes a neat, yet very cheap and effective attachment plug for laboratory requirements. Contributed by LAWRENCE MICHELS.

AN ELECTRIC "HOUND" CHASER.

For those who are troubled with neighboring dogs (hounds and such), the following scheme will be found efficacious in getting rid of them thoroughly and finally.

All that is required is a small spark coil which most experimenters have about their laboratory, together with a Leyden jar, a

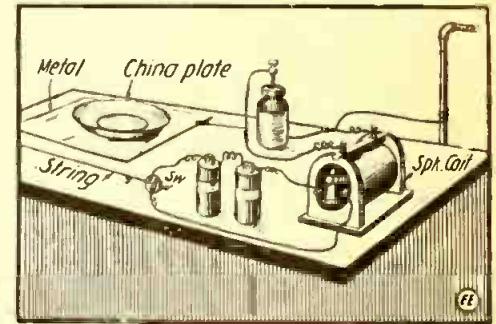

Electric Shocker for Dogs.

china plate and a piece of string with batteries and a switch for same.

The piece of string is arranged near the china plate containing milk or meat, so that when his "Riverence the Pup" strides toward the plate his foot engages the string which closes the battery switch and a metal plate or sheet under the china plate is then charged with high voltage from the spark coil.

Needless to say, this makes the most highly seasoned dish that friend "Pup" ever dined on. Contributed by C. L. ROBINSON.

A VISUAL PHOTOTELEGRAPHIC RECEIVER.

A visual receiver for phototelegraphy and tectroscopy, employing a special electrolyte, has been recently invented, says L. H. Walter, in the *Proceedings of the Royal Society*. The schematic sketch is herewith shown.

It consists of luminous elements, 5,500 in number, with independent electrical connections placed in a frame, which is hardly larger than that of an ordinary camera. The anodes *s* are embedded in an ebonite plate *c*, their backs being wetted by an electrolyte which escapes from the holes *h* of the pipe *p* and flows over the crape *e*. A voltage of 130 to 140 volts is used. The negative pole of the circuit is connected to the pipe *p*, while the anodes *s*, which are to be rendered luminous, are connected to the positive pole.

This arrangement can be used for various applications, as it combines in a lim-

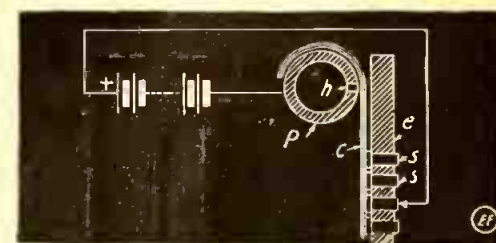

Visual Phototelegraphic Receiver.

ited space almost an unlimited number of elements, the surface of which can be illuminated or darkened hundreds of times a second at will. The degree of luminosity can be adjusted by the voltage applied.

Wireless communication between Scandinavia and America, with an intermediate station in southern Greenland, has been proposed.

A HANDY FUSE TESTER.

Many electrical experimenters have cart-ridge fuses on most of their instruments. The following diagram will show a good



Quick Test Board for Fuses and Lamps.

way to test them. This apparatus can be used to test fuses of any kind by making the block of wood to fit the length of the fuse. Contributed by

CARL MENKE.

A NOVELTY AMONG TELEGRAPH SOUNDERS.

A novel telegraph sounder of quite odd proportions is described and depicted in the following contribution:

First two wood posts are mounted in an upright position on a base of wood, neatly varnished. Then another wood rod is fastened on the upright ones at each end, as will be seen in the sketch. In other words, it is bridged across, from one to the other, as drawing depicts. A pair of electro-magnets are mounted on the bottom of the wood base, as perceived. Two binding posts are fastened to the base of the apparatus, and, of course, put in circuit with the magnets. For a clicker an iron shaft, such as door-knobs are fastened on, offers itself well for this purpose. A small spring to make tension is soldered to the steel shaft, and the other end (of spring) is tacked to the top wood piece, which is shown in sketch clearer than words can

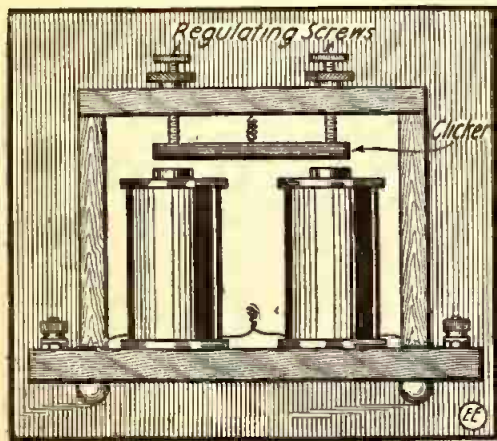

Unique Style of Telegraph Sounder.

describe it. After the regulation-screws (at the top) are properly adjusted, the instrument is ready for use. It may be put in circuit with a telegraph key, as usual. Contributed by WM. WARNECKE, JR.

MAKING A MOTOR IN 10 MINUTES.

Anyone having some wire, a few pins and a cork can construct this motor in less than 10 minutes. The armature consists of a cork having a pin stuck in each end. See that the pins are exactly in the center or the armature will wobble. Wind the armature with No. 30 enameled wire, as shown in Fig. 1. Stick four pins in a piece of wood as at Fig. 2. Arrange the armature, bearings, brushes and magnets, as in Fig. 3. The brushes are of No. 26 wire, bent as per sketch. Although simple, this motor will run very swiftly with one

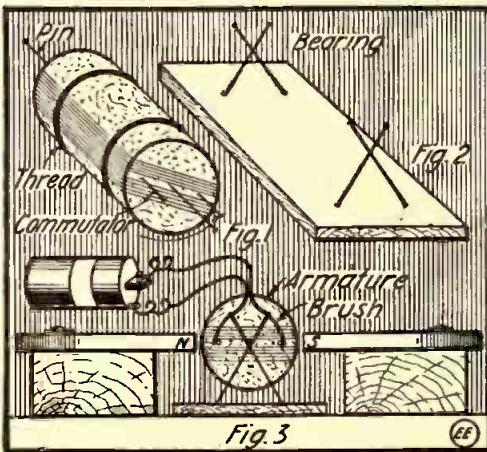

Simple Motor Made From Cork and a Few Pins.

dry cell. It also demonstrates the principle of large motors very clearly and at the lowest possible expense. Contributed by

MATT JAROSZ.

CLOSED CIRCUIT MAIL BOX ALARM.

Herewith is presented a very serviceable mail box alarm of the closed circuit type.

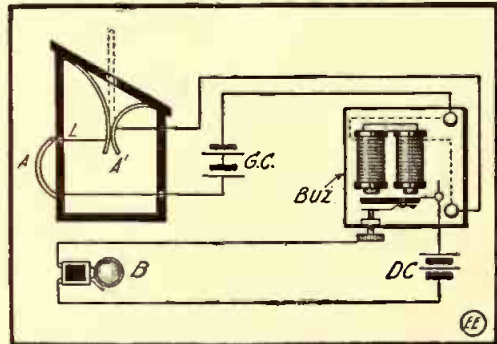

Closed Circuit Alarm for Mail Boxes.

A' is made of two light pieces of some flexible metal, and is bent, as shown, to separate when a letter is dropped in the box. A is of the same material, but much heavier, and is so constructed that when a parcel or letter is placed in contact A' is opened from L. The springs should be connected in series with each other, and a pair of "crowfoot" gravity cells is then connected to a buzzer with the windings arranged as illustrated. A bell and two dry cells are connected to the vibrator contact and to the iron armature bar of the buzzer.

When the closed circuit is broken the armature of the buzzer rebounds and closes the local bell circuit, thereby sounding the alarm and signifying that a letter or parcel is in the box. Contributed by

S. F. CSOHAR.

A SIMPLE CONNECTOR FROM PENHOLDERS.

One glance at this neat little device is sufficient to disclose its simplicity, usefulness and niftiness. It is constructed from a simple metal penpoint case (for holding

penpoints, and which usually come with Eberhard Faber's pencil sets). Two holes are drilled in on both ends of the case and posts from old batteries are fastened therein.

This is all that is necessary, and the sketch plainly shows how the device is operated to make a connection.

It is invaluable for running small motors,



Electric Connector Utilizing Pencil Tips.

lighting automobile lamps and miniature lighting systems, etc. It is merely clipped together, the action being the same as if a penpoint were taken out and the case closed again. Contributed by

ALGERNON W. WRANDON.

SOLDERING IRREGULAR PIECES.

To solder accurately irregular pieces of metal or the parts of a broken piece, press the parts into a lump of putty, placed on a piece of tinplate. Having thus formed a mould, remove and dry the putty with a gas jet. This burns the oil in the putty. When the mould is ready replace the pieces and also some solder in small pieces. Use a gas jet or blow-torch to heat same and do not remove the parts until quite cool.

BATTERY MOTOR ON ALTERNATING CURRENT.

Many experimenters have some small battery motors which they wish to run on alternating current. For this purpose the following directions will be found efficacious:

The field windings should be connected in series with a suitable high resistance. The brushes are short-circuited and then adjusted to give the greatest speed and power. It has been found that a 6-volt, 4-ampere "Knapp" motor will operate best when the lower brush is at right angles with the upper one. No connection whatever is made between the field and armature. Contributed by

PERCY M. ROOPE.

[Ed.—This is the "repulsion type" of

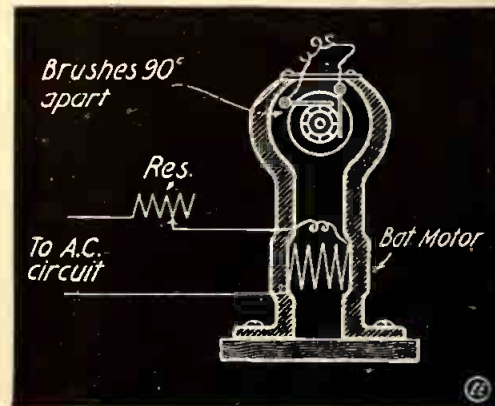

Operating Battery Motor on A. C. Circuit.

alternating current motor principle. For best results the iron frame should be laminated or made up of many soft iron sheets, firmly bolted or clamped together.]

A year's subscription would make an appropriate Xmas gift to your friend.

Wrinkles Recipes Formulas

EDITED BY S. GERNSBACK

Under this heading we will publish every month useful information in Mechanics, Electricity and Chemistry. We shall be pleased, of course, to have our readers send us any recipes, formulas, wrinkles, new ideas, etc., useful to the experimenter, which will be duly paid for, upon publication, if acceptable.

FORMULA No. 16.

Soaps.

Transparent Soap.—Slice 6 lbs. nice *Yellow Bar Soap* into shavings; put into a brass, tin or copper kettle, with *Alcohol*, $\frac{1}{2}$ gal., heating gradually over a slow fire, stirring till all is dissolved; then add 1 oz. *Sassafras Essence* and stir until all is mixed; now pour into pans about $1\frac{1}{2}$ inches deep, and when cold cut into square bars the length or width of the pan, as desired.

English Bar Soap.—Six gal. *Soft Water*, 6 lb. good *Stone Lime*, 20 lb. *Sal-Soda*, 4 oz. *Borax*, 15 lb. *Fat* (*Tallow* is best), 10 lb. *Pulverized Resin* and 4 oz. *Beeswax*; put the water in a kettle on the fire, and when nearly boiling add the lime and soda; when these are dissolved, add the borax. Boil gently and stir until all is dissolved; then add the fat, resin and beeswax.

Best Soft Soap.—Mix 10 lb. *Potash* in 10 gal. *Warm Soft Water* over night; in the morning boil it, adding 6 lb. *Grease*; then put all in a barrel, adding 15 gal. *Soft Water*.

German Yellow Soap.—*Tallow* and *Sal-Soda*, of each 112 lb.; *Resin*, 56 lb.; *Stone Lime*, 28 lb.; *Palm Oil*, 8 oz.; *Soft Water*, 28 gal. Put soda, lime and water into a kettle and boil, stirring well; then let it settle, and pour off the lye. In another kettle melt the tallow, resin and palm oil; having it hot, the lye being also boiling hot, mix all together, stirring well, and the work is done. For small quantities—*Tallow* and *Sal-Soda*, each 1 lb.; *Resin*, 7 oz.; *Stone Lime*, 4 oz.; *Palm Oil*, 1 oz.; *Soft Water*, 1 qt.

Hard Soap with Lard.—*Sal-Soda* and *Lard*, each 6 lb.; *Stone Lime*, 3 lb.; *Soft Water*, 4 gal.; dissolve the lime and soda in the water by boiling, stirring, settling and pouring off; then return to the kettle (brass or copper) and add the lard, and boil it till it becomes soap; then pour into a dish or moulds; and, when cold, cut into bars and dry it.

Camphor Soap.—*Curd Soap*, 28 lb.; *Otto of Rosemary*, $1\frac{1}{4}$ lb. Reduce the *Camphor* to powder, add 1 oz. *Almond Oil*, then sift it; when the soap is melted and ready to turn out, add the camphor and rosemary.

Sand Soap.—*Curd Soap*, 7 lb.; *Marine Soap*, 7 lb.; *Sifted Silver Sand*, 28 lb.; *Oils Thyme, Cassia, Caraway* and *French Lavender*, of each 2 oz.

Shaving Paste.—4 oz. of *Naples Soap*, 2 oz. of *Powdered Castile Soap*, 1 oz. of *Honey*, 5 drops each of *Essence of Ambergris, Oil of Cassia, Oil of Nutmegs*. Melt the soap in water bath, add honey and when nearly cool add the oils and essence.

"SOLDER" FOR METAL, GLASS AND PORCELAIN.

A soft alloy which adheres to metal, glass and porcelain and can be used in the same manner as soft solder is prepared from powdered copper (copper dust) which may be obtained by stirring a solution of blue vitriol with granulated tin. The solution becomes considerably heated and a fine brown powder is precipitated. Of this copper dust, 20 or 36 parts by weight, according to the desired hardness of the solder, are mixed in a cast-iron or a porcelain mortar with sulphuric acid of 1.85 specific gravity to the consistency of paste, and 70 parts of mercury added with constant stirring.

When the amalgam is thoroughly mixed it is carefully washed with water to remove all traces of acid, and then cooled off. In 10 or 12 hours the mass becomes very hard. When the solder is to be used it should be heated to about 400 degrees Fahrenheit, in which condition it can be kneaded like wax in an iron mortar. In this plastic state it is applied to the broken surfaces, which are then pressed together, and when cooled the amalgam adheres very firmly. Contributed by DAVID KARRON.

A DOUBLE FLAME LABORATORY BLOW TORCH.

While working in a laboratory last winter I frequently needed a blow torch for welding purposes, but as there was none in the laboratory equipment I struck upon a novel means of making the desired heat. I attached a mouth blow pipe to a gas jet

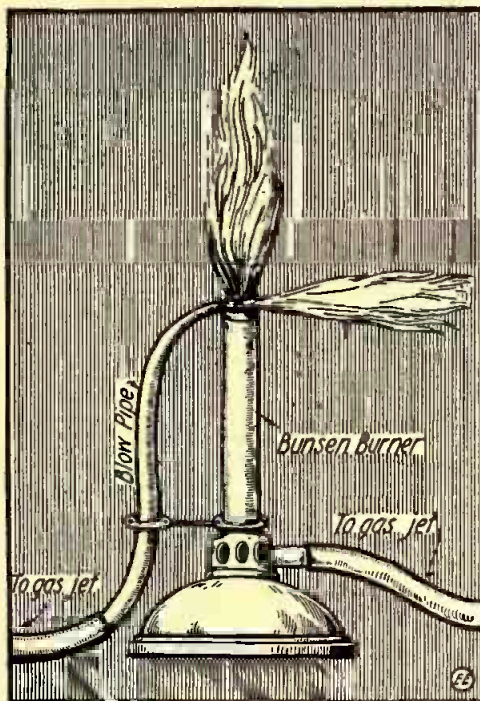

A Double Flame Laboratory Blow Torch.

by means of a rubber tube and, turning on the gas, held the blow pipe in the flame of a Bunsen burner. The gas coming through the blow pipe had the desired effect upon the Bunsen flame, producing as great or greater heat than the average blow torch.

Contributed by HARRY R. FEES.

Shabby leather can be much improved by either *Linseed Oil* or the well-beaten *Whites of Eggs* mixed with suitable coloring matter. The surface can be brought to a gloss by the use of a soft duster.

To Clean Brass.—Rub it with a mixture of *Vinegar* and *Salt*, or *Oxalic Acid*, then wash with *Water* and polish with *Tripoli* and *Sweet Oil*.

SOME USEFUL WRINKLES FOR THE EXPERIMENTER.

Turpentine makes a very good lubricant for a drill when boring thin glass.

A liberal coating of paraffine on the outside of battery jars keeps the acid from climbing.

It is hopeless to try to restore dry cells to their former strength, but after they have lost most of their voltage they can be partially restored by soaking them in a solution of salt water and drilling a number of holes around the base of the battery to let the solution soak in.

A very good way to intensify weak radio or telephone signals when using only a single pole watch case receiver is to procure a large magnet from some electrical supply store. Bind one of the poles on the back of the receiver where the screw that holds the bobbin protrudes (some little experimentation will have to be done to determine the right pole), and the signals will be found to have been increased to three and four times their previous strength.

Never try to tap your local telephone line. The company dislikes it; in fact, so violently that they may have you arrested on a serious charge. Many an innocent experimenter has gotten himself into a lot of trouble doing this.

Never try to make hydrogen gas without some knowledge of safety appliances to be used on the apparatus. It is about as quick a way to put your eyes out as there is.

If you are using storage batteries in your wireless set, and they fail to give proper voltage, or get too hot, don't try to fix them yourself, as they can be very easily ruined. A garage man can't fix in a day what you can "unfix" in 10 minutes.

Don't light matches around storage batteries to see if they are working properly. When operating they liberate a gas which is at times very explosive. Use a pocket flashlight.

If you are disturbed by alternating currents interfering with your wireless receiving set turn your aerial in another direction. It may help.

If you can get your wireless instruments silver plated, do so by all means, as silver is a much better conductor than nickel, and high frequency currents such as are used in wireless work travel almost entirely on the surface of switches.

If you are intending to buy any instrument and don't know the size, range, adaptability to your requirements, etc., don't be afraid to ask the manufacturer about the instrument. Even if he does have a catalogue, he will be glad to give you any additional information you desire.

When experimenting with 110-volt current always have a pair of 10 amp. fuses in circuit. It will stop a lot of pyrotechnics if something goes wrong.

Don't paint the stand that you intend to mount your instruments on. Paraffine is better; it don't allow so much current to leak through.

Contributed by WARD B. BABCOCK.

Rust spots on nickel can be treated with *Grease*, and after several days rubbed with a rag saturated with a few drops of *Hydrochloric Acid* in *Ammonia*. Parts should be thoroughly rinsed, dried and polished.

Aluminum Polish.—An emulsion of equal parts of *Rum* and *Olive Oil* can be used for cleaning aluminum. *Potash Lye*, not too strong is also effective in brightening aluminum; *Benzol* is also used.

A good polish for aluminum consists of a paste formed of *Emery* and *Tallow*, the finish luster being obtained by the use of *Rouge Powder* with *Oil of Turpentine*.

WITH THE AMATEURS

Our Amateur Radio Station Contest is open to all readers, whether subscribers or not. The photos are judged for best arrangement and efficiency of the apparatus. To increase the interest of this department we make it a rule not to publish photos of stations unaccompanied by that of the owner. Dark photos preferred to light toned ones. We pay each month \$3.00 prize for the best photo. Make your description brief. Address the Editor.

AMATEUR RADIO STATION CONTEST.

Monthly Prize, \$3.00.
This month's prize winner.

WIRELESS STATION AND ELECTRICAL LABORATORY OF FRANK H. BROOME.

The accompanying photo shows the sending and receiving outfits, also the main switchboard controlling the other laboratory and experimental apparatus, most of which is on a slate table not shown in the photo.

The wireless receiving outfit is of the

Mr. Frank Broome is an Ardent Radio and Electrical Student. Here We See Him Surveying a Mast Site.

Below: The Radio Laboratory of Mr. Broome is Up-to-date and Contains Transmitting and Receiving Apparatus with Amplifier.



semi-cabinet type, most of the instruments of which have been described by the owner in *The Electrical Experimenter* during the past year. All of the instruments are of the owner's design and make, and have proved of exceptional worth. They consist of a loading coil, loose coupler, variable and adjustable condensers, crystal detector and 'phones. The horn was used in connection with a receiver in receiving from WHB, NAH and other near-by stations.

The present sending set consists of a 1-inch coil, operated in connection with an electrolytic interrupter on 110 volts alternating current; Leyden jar condenser, helix, hot-wire ammeter and key. Aerial is "T" type, 40 feet high and 100 feet long.

The aerial and lightning ground switch are both conveniently located, and can be operated from the switchboard panel.

The laboratory apparatus consists of step-down transformers, rectifiers, arc lamps, electric furnaces, storage batteries, etc., all of which are home-made. Tools and raw material are conveniently kept under the wireless table.

The station is over five years old, and during that time *The Electrical Experimenter* or its predecessor, *Modern Electrics*, was always to be found in its library.

FRANK H. BROOME.

Roselle Park, N. J.

RADIO OUTFIT OF JACOB WEISS.

I take this occasion to enter my station in your monthly contest. My station consists of a 1-kw. closed-core transformer (made by Queen & Co.), pancake oscillation transformer, rotary gap, consisting of motor-driven disc containing 13 studs (r.p.m. 6,000), and three Murdock condenser units. I use a break-in system, eliminating the aerial switch, and a magnetic key. The key operates the magnetic relay, which in turn operates the break-in relay. My transmitter is in the basement of my home and my receiving set is in the dining room on the first floor. I use a small Pittsburgh step-down transformer on 110 volts to operate a relay type motor starter. The relay for the motor is energized by a small foot-plate push mounted on the floor under the table.

My receiver consists of a loose coupler, primary and secondary rotary condensers and Audion amplifier, with 2,400-ohm 'phones. There are of course the necessary batteries and resistances to go with the audions. I use the series-shunt system for condenser on the primary coil.

I have no trouble in getting the distant stations very well. On Oct. 18 last I heard N.A.W. very plainly. I have held communication with Western stations regularly at such times as I have happened to be at home. During the winter months I worked 8 P.P., 8 A.M., 9

K.U., and was received at a station in Chicago, Ill., and at Winnetka, Ill. Also I have worked stations in Wheeling, W. Va.; Cleveland, O.; Little Valley, N. Y., and 8 O.Z., Pennsylvania.

I hold a certificate of the American Radio League as an official relay station; also first-grade commercial license. I am a reg-



Mr. Weiss Gets Excellent Results With His Radio Receiving Set.

ular subscriber to *The Electrical Experimenter* and find it excellent in its contents and suggestions.

JACOB WEISS, Asso. M. I. R. E.
Port Washington, L. I.

G. L. LA PLANT'S RADIO STATION.

I give here a brief description and photograph of my station, and would be pleased to have you publish them in your journal. The receiving apparatus consists of an R. J. 5 Audion detector, Blitzen receiving transformer and rotary variable condenser; also three pairs of 2,000-ohm 'phones. The transmitting set is composed of a Blitzen 1-kw. transformer, rack type condenser, oscillation transformer and Marconi type discharger. As the discharger is extra



1 KW. Transmitting Set and Also Receiving Apparatus of G. L. La Plant's Radio Station.

large I will give the dimensions for those who wish to build one. It is made of a hard rubber disc 10 inches in diameter, 1/4 inch thick, with 13 studs on the side of the disc placed 3/4 inch from the outer edge. The motor is a Robbins & Meyers 1/10-hp. style, running at 2,400 r.p.m. The aerial consists of four No. 14 H. D. W. P. copper wires spaced 2 1/2 feet apart and is 80 feet high and 150 feet long. It is insulated with Electrose 4-inch insulators.

I am a member of the Central Association, American Relay League and also corresponding secretary of the Hawkeye Radio Association. My call is 9.K.T.

St. Anthony, Ia. G. L. LA PLANT.

CHARLESTOWN NAVY YARD RADIO CLOSED.

While the divisional radio is being secured the wireless station at the Charlestown, Mass., Navy Yard will be closed and all messages will be received at the Chelsea station. This will be for several months. The station at the navy yard has been dismantled and the apparatus has been set up at the Chelsea station. Messages received at Chelsea will be sent by "wire" to the Charlestown station.

J. W. ALLEN AND HIS WIRELESS "LAB."

The illustration herewith depicts my wireless station. At the left is the receiving set, consisting of a loose coupler, two specially designed silicon detectors, a double slide tuner, a large variable condenser and fixed condenser. I have two aerials,

Mr. J. Wyman Allen, owner of the Experimental Radio Station Shown Below.
Below: Well Arranged Radio Set Mounted on Desk.



double slide tuner set, and the variable condenser may be shunted between the aerial and ground or may be switched in series with aerial. I have a 2,000 ohm double head set and a 1,000 ohm single head set. My sending outfit is a 1/4 k.w. set with a Clapp-Eastham rotary gap. I have no aerial switch as I use a break-in system. My receiving apparatus has a range of 100 to 3,000 meters wave length.

J. WYMAN ALLEN.

Beverly, Mass.

HAMMOND PROFFERS INVENTION TO NAVY.

John Hays Hammond, Jr., recently laid before Secretary Daniels and ordnance experts of the navy the wireless device which he has perfected to direct torpedoes discharged from submarines.

Secretary Daniels declined to give the mechanical make-up of the device. He said, however, it may be of incalculable advantage to the navy.

H. LIGHTNER'S REMARKABLE POCKET RADIO SET.

After seeing the wireless sets pictured in your Prize Contest Department I decided to submit a snapshot of a pocket wireless designed and constructed by myself.

The outside dimensions of this set are 8x4x2 inches, while the weight is only two pounds without the receivers. I use one of the E. I. Co. dime galena detectors and find it extremely sensitive. My headset consists of two 2,000-ohm Brandes' Superior type receivers, which are very good. My condenser and coils are of my own make and have sufficient inductance to bring in high wave-length stations.

This set is able to receive NAA, WSL,

WCX; several lake boats, including the C. & B. boats, and numerous unidentified stations. NAA comes in loud enough to be heard 26 inches away from the 'phones. By



Mr. Lightner Has Perfected an Efficient Pocket Radio Receiving Set.

using a bed spring as an aerial I have picked up the first three stations above mentioned. HERBERT LIGHTNER.

Alliance, O.

one six-wire aerial 90 feet long and 60 feet high, for sending, and one two-wire aerial 200 feet long and 60 feet high, for receiving. Either or both of these aerials may be switched on for receiving by means of the two two-point switches seen on the front of the receiving set. The set is wired up so that by manipulating the switches on the front of the cabinet the hook-up may be changed from a loose coupler to a

Amateur News

The Institute of Radio Engineers' October Meeting.

At the regular monthly meeting, held on Oct. 6, at Columbia University, New York City, The Institute of Radio Engineers had the pleasure of hearing a timely paper on the subject of "The Training of the Radio Operator," by Mr. M. E. Packman, professor of Radio Telegraphy at Dodge's Telegraph, Railway and Wireless Institute, Valparaiso, Ind. Mr. Packman's discourse covered the method found best for instructing embryo radio operators, and covers such matters as the type of apparatus best suited to transmit code practise signals, number of subjects to be taught, length of time required to thoroughly teach the operator the necessary rudiments of electricity and radio operation, etc.

The point was brought out that in most cases, and taking for granted that each applicant to the school has a fairly good general education, such as given in grammar schools, that a finished radio operator could be turned out in about six months. About 600 students have been enrolled annually at this school and one-third of them are radio students.

The pupil is taught typewriting and penmanship as well as all necessary wireless instruction for the reason that most telegraphic and radio messages today are copied direct on the typewriter and, of course, in any event the wireless man in charge of a station should be a first-class penman. Geography and other practical branches of study are also gone into at this school with good results. The practical side of the radio operating profession is also covered, so far as becomes possible in the short length of time the student has at his disposal. This covers such matters as the routing of messages, repetition of messages, the various codes and modifications as well as abbreviations in use internationally, etc. The fact was brought out that most of the radio operators graduated are in the Marconi service, as this company controls the major portion of the radio business to-day. The short-comings of young radio operators were brought out and the speaker offered several suggestions tending to offset these, if proper training was given in the school.

Boston Radio Amateurs, Attention

Radio amateurs located in or near Boston interested in forming a wireless association with headquarters and a central station will do well to inquire for particulars at The Young Men's Christian Union, 48 Boylston St., Boston, Mass.

Maple City Radio Club of Hornell, N. Y.

The "Maple City Radio Club" was organized on Oct. 2, 1915, with the following officers: Guy

Loper, president; James Stephens, vice-president; Robert Shults, secretary; Benedict French, chief operator, and the following as members: Raymond Wright, Carl Mead, Sidney Emerson, Carl Chapman, Walter Howard.

All correspondence should be addressed to the secretary at 179 Main Street, Hornell, N. Y.

Bronx Radio Club.

At the last October weekly meeting of the Bronx Radio Club of New York, the election of new officers was held, the result of which was as follows: M. Haber, president; J. Smith, vice-president; A. Schoy, business manager; H. Berlin, secretary; A. Richter, treasurer.

A lecture was delivered by one of the members on "The Theory of Wireless Transmission."

Lectures are given at every meeting by the more advanced members of the club, dealing with timely topics of wireless or electrical interest.

The club will be glad to communicate with other societies and individuals desirous of having information or particulars of the proceedings of this organization.

All communications should be addressed to the secretary, 705 Home St., Bronx, New York. Those wishing to call on the president may do so at his home, 670 E. 170th St., Bronx, New York.

Ames, Iowa, Has Radio Society.

The second annual convention of the Hawkeye Radio Association was held at Ames, Iowa, on Sept. 1 and 2. It was well attended and proved a success in every way. The meeting on Sept. 1 was attended by wireless amateurs from all over the

State. The following officers were elected: President, Ralph Batchler, 131 Hyland Ave., Ames, Iowa; Vice-President, W. P. Rathert, Cresco, Iowa; Secretary, A. B. Church, Lamoni, Iowa; Treasurer, Hollis Sels, 131 Hyland Ave., Ames; Corresponding Secretary, G. L. La Plante, St. Anthony, Iowa.

The association has had published a monthly bulletin containing from one to three pages filled with articles of interest to the members. This will be continued and enlarged during the next year. Information will be given applicants by the officers, regarding membership. We are trying to get a complete directory of the amateurs residing in Iowa, and the president would be glad to obtain any information relating to such a directory.

Much interest was afforded the members by a large display of the most modern types of radio apparatus, which was kindly loaned for the occasion by some of the well-known wireless manufacturers.

Savannah, Ga., School Wireless Licensed.

Arthur Funk, amateur radio operator, who has for the last two years been perfecting the station he has now installed on top of the High School at Savannah, Ga., recently received his operator's license from the Government.

It is a license for "Commercial, experimental and instruction purposes," and was obtained primarily to enable him to pursue research work in connection with the problems of the station. His call letters are 4AH.

Mr. Funk is also endeavoring to install a wireless 'phone, working along a theory of his own, and has already begun work on the instruments. He is working independent of the lines followed by experimenters in the recent Government successful wireless 'phone tests.

The station, which was constructed entirely at the High School, has a sending radius of 100 miles and the operator has picked up messages from Colon, Panama and the naval stations at Guantanamo, Cuba. Among other devices that have been recently installed is a marble switchboard, and the lightning switch has been placed outside the school to minimize the danger from that source.

Middletown Scientific Association Holds 410th Meeting.

The 410th meeting of the Middletown Scientific Association was held in the Scott Laboratory of Physics at Wesleyan University, on the evening of Oct. 13 last. The address was by Professor Walter Guyton Cady, Ph.D., professor of physics in Wesleyan University, on the subject, "Wireless Telegraphy." The lecture was illustrated with experiments and lantern slides.

RADIO CLUBS ATTENTION!

We are always pleased to hear from young Edisons and Radio Clubs. Send a write-up of your Club with photos of members and apparatus to-day to: Editor "Amateur Gossip" Section, The Electrical Experimenter, 233 Fulton St., New York City.



LATEST PATENTS

Flashlight for Canes and Umbrellas.

(No. 1,151,114; issued to Gustav Matthies and August Rehberg, Jr.)
This patent covers a neat arrangement for a small flashlight bulb, together with necessary battery of miniature dry cells and switch for controlling the lamp circuit in a cane.

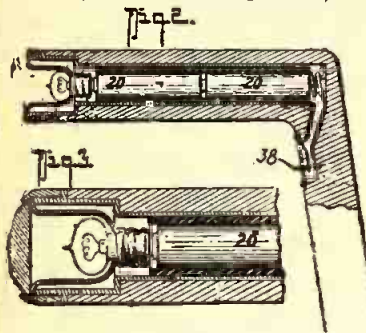

The drawing clearly shows how these parts are arranged and the lens of the flashlight is indicated while the push button appears at 38. The miniature dry cells are shown at 20.

Electric Apparatus Enabling the Blind to Read.

(No. 1,149,547; issued to Henry Tideman.)

Intended to aid the blind to read, makes use in general of special books containing a perforated page, which

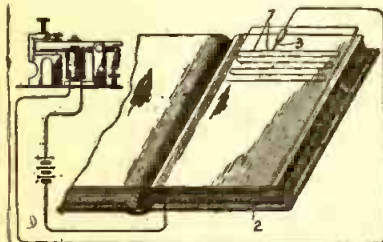

perforations correspond to the dots and dashes of the Morse telegraph code. A regular sounder (or a telephone receiver type sounder) may be used, together with battery, as shown in diagram, and this circuit is opened and closed by means of a metal stylus 3, which is moved over the perforations 7, on the page. Under the page lies a metal plate, which is connected with the opposite side of the circuit. Several other unique schemes are covered in this interesting patent.

Thermostatic Circuit-Closer for Incubators.

(No. 1,151,142; issued to Louis L. White.)

A modified form of thermostatic circuit closer for incubators and the like, the closing and opening "valves" of which are easily adjusted for, as by means of a dial

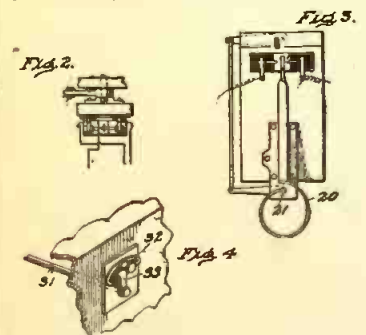

and handle 31 and 33, placed on the exterior of the incubator. The handle 33 is secured to a shaft 31, which in turn connects by means of levers to the pivot 21. A thermoelectric element 20, which is of circu-

lar form as perceived, is composed of strips of brass and steel soldered together. This thermostat is used to regulate a motor or other electrical attachments for opening and closing dampers or doors, so as to keep the incubator at a practically constant temperature.

Arc Type Telephone Transmitter.

(No. 1,150,266; issued to Walton Harrison.)

A telephone transmitter intended to be used with heavy currents, such as for loud-talking telephone circuits, wireless telephony, etc. The air waves set up by speaking into the horn 37 are caused to impinge against the arc at 27. Controlling electro-magnets, which aid in the operation of this arrangement, it is said, are shown at 15. It acts on the principle that the variable air currents, corresponding to the voice waves, will cause the arc 27 to change in its length and resistance,

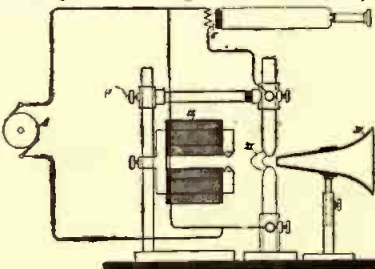

thereby varying the strength of the current through an induction coil 6, which is joined to a loud-speaking telephone, etc.

Electro-Magnetic Sound Producer.

(No. 1,147,016; issued to Leo Grubman, assignor to Electric Spark Appliance Co., Inc.)

A novel form of electro-magnetic sound producer, intended for use particularly on Ford automobiles, whose magnetos yield alternating current. This horn has an electro-magnet coil C, mounted in a magnetic or iron frame with pole pieces, as drawing shows. The flux from the pole pieces reacts on a distinct magnetic armature H. This, when

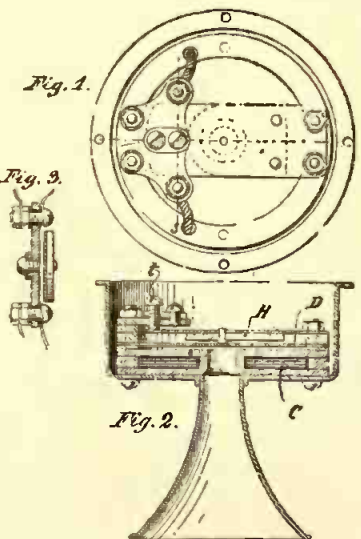

attracted forward, moves the diaphragm proper "D" naturally, and also in its return movement, the diaphragm "D" acts resiliently on the armature H. By this action the inventor claims to attain the best results for this form of construction. A tuning screw t is provided for properly adjusting the armature vibration period. No interrupter is used.

Radio Telegraphic Coherer.

(No. 1,150,111; issued to Edwin R. Gill.)

Another advance in the design of

coherers for radio telegraphic or other requirements. The inventor lays great stress on the proper formation of the spherical chamber 13, in which metallic or other filings are contained. Also he mentions that if

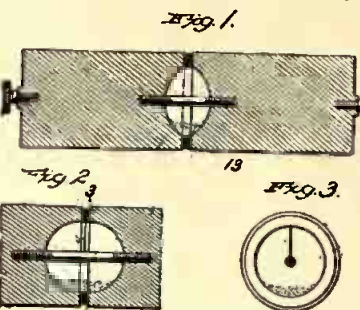

these filings are of the proper size, and also by utilizing a periodically changing sweeper, or mixer, that it is possible to obtain very regular and reliable results with a coherer so constructed. Again he mentions the use of a number of such coherers on a common circuit and each one of these coherers to be successively but independently switched into circuit by proper means, and thus while one is decohering another one will be in circuit to perform the regular function of such a device.

Electric Humidor.

(No. 1,145,218; issued to Walter E. Schimmel.)

This type of humidor, used to produce a damp vapor from water or other liquid, utilizes an electric lamp

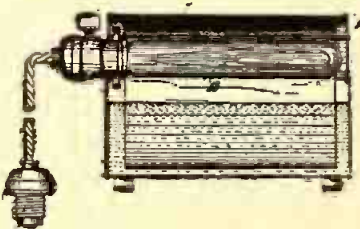

13, placed in the upper part of a chamber 9. In order to improve the operation of this device blotting paper or some other good absorbent is supported in the vaporizing chamber from rods 16, and this causes the water to be drawn up near the lamp and thus the vaporization is greatly enhanced. The moist vapor produced in this way can then escape through perforations in the top of the containing vessel.

Radio Detector Stand.

(No. 1,152,444; issued to Augustus K. Sloan, Jr.)

Another radio detector stand which embodies several good features, it seems, with respect to the spring tension adjustment for the "cat-whisker" electrode. By means of an ad-

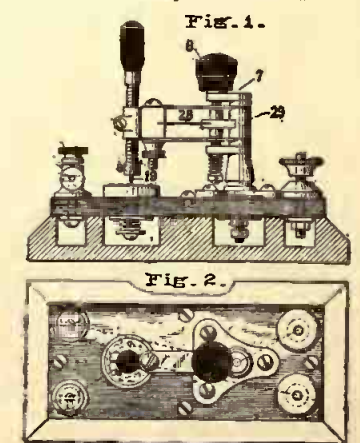

justing knob 8, the tension exerted by the metal point electrode 19 is

very accurately adjustable owing to the unique construction, which employs a flat tension spring 28, secured to a movable block 29. This block 29 can be raised or lowered independently by turning knob 8. Also the electrode 19 may be moved over the face of the crystal rapidly owing to the novel construction of pillar 7, which permits the whole spring arm arrangement to be swung from side to side.

Wireless Condenser.

(No. 1,150,895; issued to Augustus Kellogg Sloan.)

A newly devised variable condenser suitable for radio or other circuits and comprising a number of concentric metal tubes nested together as

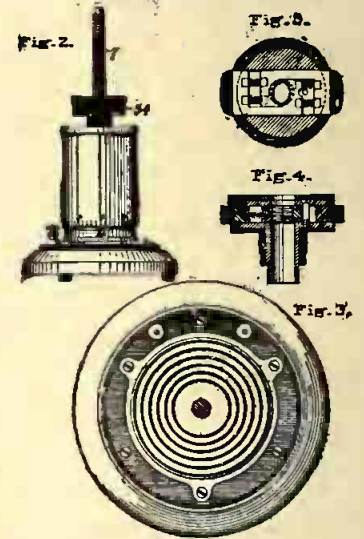
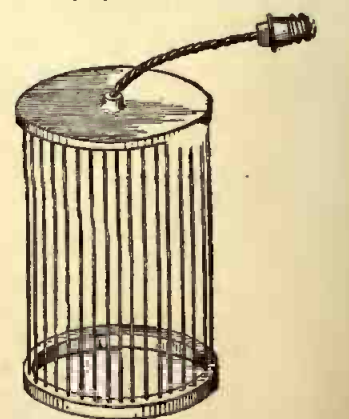

illustration shows. Every other tube connects to one pole of the condenser and one set of tubes may be moved up and down to vary the capacity by means of a special insulated handle 34. This handle is threaded and the nut within same is made in two halves; thus it is possible to compress the nut sections so that the moving element can be slid up and down the threaded vertical rod rapidly. For the fine adjustment the handle 34 is released and the split threaded nut engages the screw 7, so that the plates can be accurately and closely varied in their relative position.

Electric Insect Trap.

(No. 1,150,835; issued to Joseph Satinover.)

It is proposed with this device to



electrocute insects of all kinds by arranging two sets of oppositely charged wires or metallic rods to form a cage, as perceived in the illustration. These oppositely charged wires are here, of course, and spaced a short distance apart. They will work on a 110 volts and alternating current or direct current, the same as that supplied for lighting.

COPIES OF ANY OF THE ABOVE PATENTS SUPPLIED AT 10c. EACH.

Phoney Patents

Under this heading are published electrical or mechanical ideas which our clever inventors, for reasons best known to themselves, have as yet not patented. We furthermore call attention to our celebrated Phoney Patent Offizz for the relief of all suffering daffy inventors in this country as well as for the entire universe.

We are revolutionizing the Patent business and OFFER YOU THREE DOLLARS (\$3.00) FOR THE BEST PATENT. If you take your Phoney Patent to Washington, they charge you \$20.00 for the initial fee and

then you haven't a smell of the Patent yet. After they have allowed the Patent, you must pay another \$20.00 as a final fee. That's \$40.00!! WE PAY YOU \$3.00 and grant you a Phoney Patent in the bargain, so you save \$37.00!! When sending in your Phoney Patent application, be sure that it is as daffy as a lovesick bat. The daffier, the better. Simple sketches and a short description will help our staff of Phoney Patent examiners to issue a Phoney Patent on your invention in a jiffy.

PHONEY PATENT OFFIZZ

PHONEY PATENT PERPETRATED BY WATT A. LUNKHED

ELECTRO OFFICE EFFICIENCY DEVELOPER

Pat. Applied Externally

No. Px6 $\sqrt{Lx4}$

To all who should worry:

Be it known that I, Watt A. Lunkhed, of the City of Oful State of Affairs, have deliberately sacrificed my fortune and last ray of sanity in devising, developing and perfecting this apparatus for alleviating the troubles of all poor stenographers who are troubled with a lack of ambition. It has worked perfectly under all conditions. Many girls preferring it to the effeminate attentions of mushy office managers, the latter are not required on the payroll any longer.

the letter-head and starts typing. As she presses the keys real movies appear on the screen in front of her. The scenes appear in perfect synchronism with the striking of the keys, therefore fast work is necessary so she can find out quickly how it all ends.

A touch on the spacing bar automatically turns lose the Victrola with a lot of love melodies and mushy ballads, in perfect keeping with the movies.

When the carriage is pushed back after

motor should be at least two horse-power—this is a small detail that should be carefully attended to.

For best results with this recipe for efficiency it is absolutely necessary that only pure ingredients be used—thus purely emotional motion pictures—pure high grade chocolates, and purely sentimental music should only be employed.

This machine has been tested by all the crowned heads and blockheads of Europe and New Zealand, proving in every case

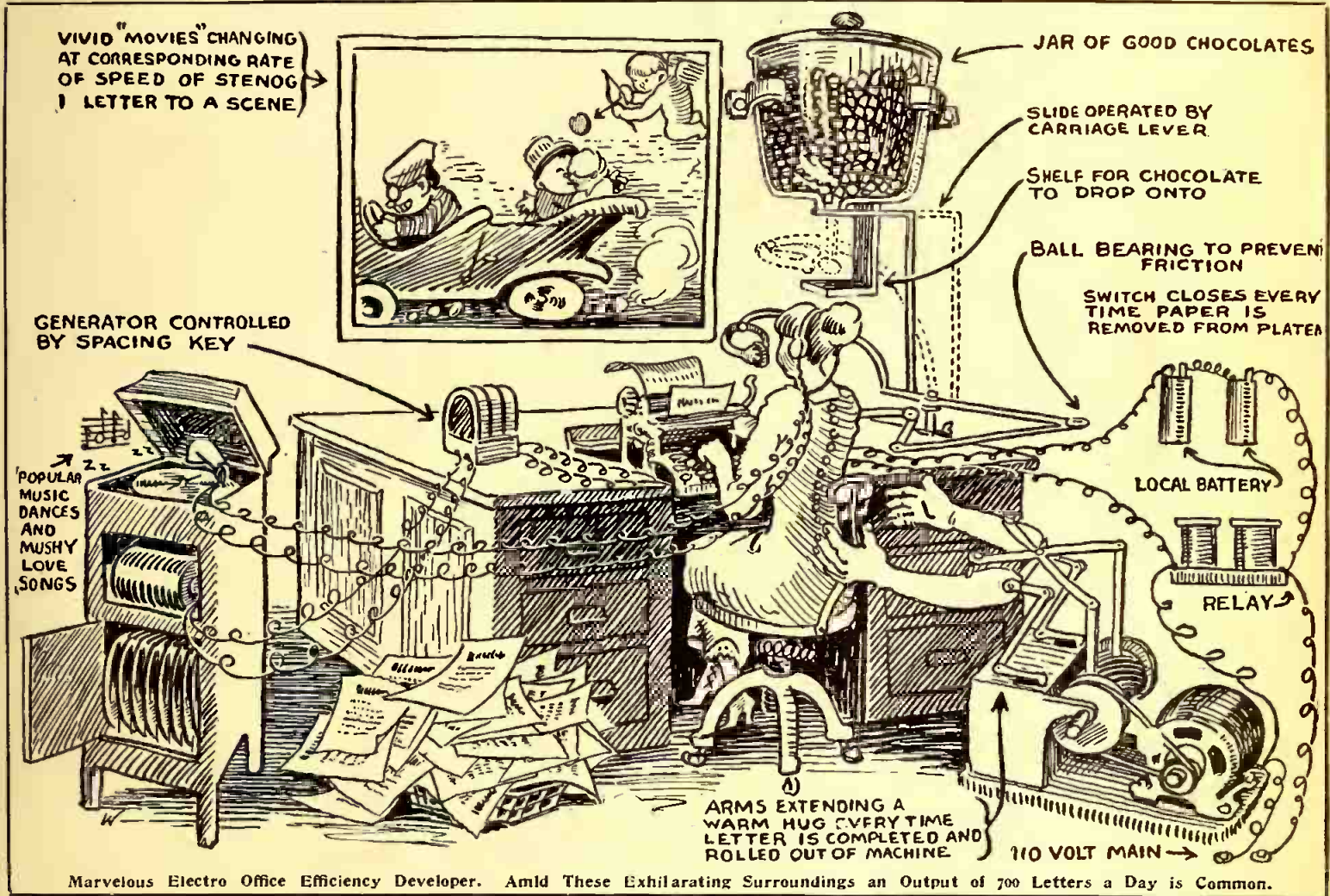

Marvelous Electro Office Efficiency Developer. Amid These Exhilarating Surroundings an Output of 700 Letters a Day is Common.

The results are based upon the formula $E = \frac{P}{W}$ where E. = efficiency P. = pleasure and W. = work. By increasing both factors of the fraction it is apparent that the results will not be changed, thus doubling the work can be offset by increasing the pleasure an equal amount, thereby retaining the same efficiency, and vice versa.

The apparatus is arranged as per attached drawing and its operation is as follows:

After the stenographer has taken all the letters (700 a day is common when this machine is installed), she sits down, inserts

each line, a system of levers (not lovers) delivers a luscious chocolate to her rosy lips. The supply of delicacies is contained in the large glass jar at the right, and if the boss is of a sporting disposition he can offer prizes to the stenog emptying the jar first.

The master stroke of my invention is found in the hugging attachment operated each time a letter is removed from the machine. The motor operated arms clasp her firmly but tenderly around the waist and hug her as good as any mere man without the attendant smell of cheap tobacco, which latter oftentimes accompany this blissful pastime. For best results this

that woman, with the aid of this machine, is complete in herself, does not require the association of males and therefore should rule herself.

In testimony thereof I therefore bury here my tame seal on this day of devotion and supplication to Woman Beautiful in this City of Oful State of Affairs.

WATT A. LUNKHED.
By his Attorney:
S. A. TROMBLY,
Worcester, Mass.

Witnesses:
G. WATASINCH,
LILL Q. PIDT,
ROMEO CHEESIT.

OFFICIAL LIST OF LICENSED RADIO AMATEURS NOT TO APPEAR IN NEW GOVERNMENT CALL BOOK. PRESERVE THIS LIST FOR FUTURE REFERENCE.

Amateur Radio Stations Licensed by the Bureau of Navigation During the Month of July, 1915.

Table with columns: Call signal, Owner of station, Location of station, Power in watts. Divided into districts: FIRST DISTRICT, SIXTH DISTRICT, SEVENTH DISTRICT, EIGHTH DISTRICT, NINTH DISTRICT.

Amateur Radio Stations Licensed by the Bureau of Navigation During the Month of September, 1915.

Table with columns: Call signal, Owner of station, Location of station, Power in watts. Divided into districts: FIRST DISTRICT, SIXTH DISTRICT, SEVENTH DISTRICT, EIGHTH DISTRICT, NINTH DISTRICT.

OFFICIAL CODE CHARTS GIVING INTERNATIONAL RADIO SIGNALS, CONVENTIONS AND ABBREVIATIONS.

INTERNATIONAL RADIOTELEGRAPHIC CONVENTION

LIST OF ABBREVIATIONS TO BE USED IN RADIO COMMUNICATION

ABBREVIATION	QUESTION.	ANSWER OR NOTICE
PRB	Do you wish to communicate by means of the International Signal Code?	I wish to communicate by means of the International Signal Code.
QRA	What ship or coast station is that?	This is
QRB	What is your distance?	My distance is degrees.
QRC	What is your true bearing?	My true bearing is degrees.
QRD	Where are you bound for?	I am bound for
QRE	Where are you bound from?	I am bound from
QRF	What line do you belong to?	I belong to the Line.
QEG	What is your wave length in meters?	My wave length is meters.
QEH	How many words have you to send?	I have words to send.
QEI	How do you receive me?	I am receiving well.
QEK	Are you receiving badly?	I am receiving badly. Please send 20 meters.
QEL	Are you being interfered with? for adjustment.
QEM	Are the atmospherics strong?	I am being interfered with.
QEN	Shall I increase power?	Atmospherics are very strong.
QEO	Shall I decrease power?	Increase power.
QEP	Shall I send faster?	Decrease power.
QEQ	Shall I send slower?	Send faster.
QES	Shall I stop sending?	Send slower.
QET	Have you anything for me?	Stop sending.
QEU	Are you ready?	I have nothing for you.
QEV	Are you busy?	I am ready. All right now.
QEW	Shall I stand by?	I am busy (or: I am busy with). Please do not interfere.
QEX	When will be my turn?	Stand by. I will call you when required.
QEY	Are my signals weak?	Your turn will be No.
QEZ	Are my signals strong?	Your signals are weak.
QSA	Is my tone bad?	Your signals are strong.
QSB	Is my spacing bad?	The tone is bad.
QSC	What is your time?	The spark is bad.
QSD	Is transmission to be in alternate order or in series?	Your spacing is bad.
QSE	What rate shall I collect for?	My time is
QSF	Is the last radiogram canceled?	Transmission will be in alternate order.
QSG	Did you get my receipt?	Transmission will be in series of 6 messages.
QSH	What is your true course?	Transmission will be in series of 10 messages.
QSI	Are you in communication with any ship or station (or: with)?	Collect.
QSQ	Shall I inform that you are calling him?	The last radiogram is canceled.
QSR	Will you forward the radiogram?	Please acknowledge.
QST	Have you received the general call?	My true course is degrees.
QSU	Please call me when you have finished (or: at o'clock)?	I am not in communication with land.
QSV	Is public correspondence being handled?	I am in communication with (through Inform that I am calling him.
QSW	Shall I increase my spark frequency?	You are being called by
QSX	Shall I decrease my spark frequency?	I will forward the radiogram.
QSY	Shall I send on a wave length of meters?	General call to all stations.
QSZ		Will call when I have finished.
QTA		Public correspondence is being handled. Please do not interfere.

*Public correspondence is any radio work, official or private, handled on commercial wave lengths. When an abbreviation is followed by a mark of interrogation, it refers to the question indicated for that abbreviation.

These Code charts are supplied by the Department of Commerce, Washington, D. C. The new edition of "Radio Stations of the United States" can be obtained from the Superintendent of Documents, Washington, D. C.

INTERNATIONAL MORSE CODE AND CONVENTIONAL SIGNALS

TO BE USED FOR ALL GENERAL PUBLIC SERVICE RADIO COMMUNICATION

1. A dash is equal to three dots.
2. The space between two letters is equal to three dots.
3. The space between two words is equal to five dots.
4. The space between parts of the same letter is equal to one dot.

A	•••••	Period
B	•••••	Semicolon	•••••
C	•••••	Comma	•••••
D	•••••	Colon	•••••
E	•••••	Interrogation	•••••
F	•••••	Exclamation point	•••••
G	•••••	Apostrophe	•••••
H	•••••	Hyphen	•••••
I	•••••	Bar indicating fraction	•••••
J	•••••	Parenthesis	•••••
K	•••••	Inverted commas	•••••
L	•••••	Underline	•••••
M	•••••	Double dash	•••••
N	•••••	Distress Call	•••••
O	•••••	Attention call to precede every transmission	•••••
P	•••••	General inquiry call	•••••
Q	•••••	From (de)	•••••
R	•••••	Invitation to transmit (go ahead)	•••••
S	•••••	Warning—high power	•••••
T	•••••	Question (please repeat after)—interrupting long messages	•••••
U	•••••	Wait	•••••
V	•••••	Break (Bk.) (double dash)	•••••
W	•••••	Understand	•••••
X	•••••	Error	•••••
Y	•••••	Received (O. K.)	•••••
Z	•••••	Position report (to precede all position messages)	•••••
Ä (German)	•••••	End of each message (cross)	•••••
Á or À (Spanish-Andaluciana)	•••••	Transmission finished (end of work) (conclusion of correspondence)	•••••
CH (German-Spanish)	•••••		
É (French)	•••••		
Ñ (Spanish)	•••••		
Ö (German)	•••••		
Û (German)	•••••		
1	•••••		
2	•••••		
3	•••••		
4	•••••		
5	•••••		
6	•••••		
7	•••••		
8	•••••		
9	•••••		
0	•••••		

QUESTION BOX

This department is for the sole benefit of the electrical experimenter. Questions will be answered here for the benefit of all, but only matter of sufficient interest will be published. Rules under which questions will be answered:

1. Only three questions can be submitted to be answered.
2. Only one side of sheet to be written on; matter must be typewritten or else written in ink, no penciled matter considered.
3. Sketches, diagrams, etc., must be on separate sheets. Questions addressed to this department cannot be answered by mail.

MAKE AND BREAK COIL OPERATION.

(368.) Montgomery Joseph, Cove, Tex., wants information regarding: (1) The operation of "make and break" coils for

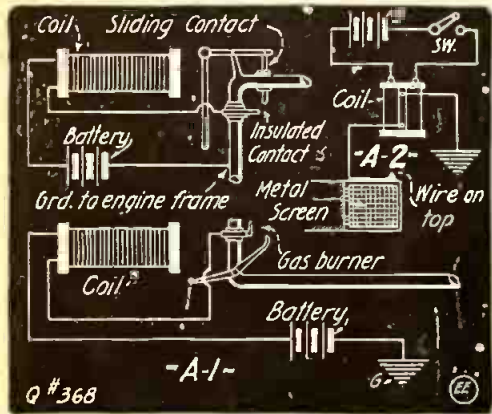

Fig. A-1. Hook-ups for "Wipe" Spark Gas Ignition Coils. Fig. A-2. Connection of "Jump" Spark Coil to Fence Gate.

ignition purposes, and (2) a method of protecting a gate or other entrance by using high-tension induction coils.

A. 1. The diagram given herewith shows how a "make and break" spark coil is used on gasoline engines or igniting gas burners, etc. It works on the principle of self-induced currents, which increases the battery potential at break of the circuit.

A. 2. You can protect a gate, as you mention, with a spark coil by simply hooking up proper switching arrangements operated in the house or by action of the gate itself, and this switch should be placed in the primary circuit of the coil as the diagram indicates. A pair of copper wires secured to the gate might carry the current from the secondary of the spark coil to give the shock, or one secondary lead may be grounded.

SODIUM VAPOR AND SPARK GAPS.

(369.) Francis Feig, Jr., New York City, asks: (1) How to obtain sodium vapor, and (2) the effect of lengthening the spark on the primary input to a spark coil.

A. 1. Sodium vapor is obtained from "Na" or sodium proper. The sodium is usually heated, and by proper appliances the vapor is gathered from same. The vaporizing point of sodium is about 95 deg. C. We have been unable to locate any definite data on the resistance of sodium vapor, and in this direction wish to suggest that you might communicate with Dr. A. N. Goldsmith, care of College of the City of New York, New York, who undoubtedly can supply data on this point.

A. 2. As the spark gap is reduced in length the primary will tend to draw more current. This is not so noticeable with an ordinary spark coil excited with dry batteries as becomes the case when a regular alternating current transformer is used, owing to the peculiar action resultant from the spring vibrator.

WAVE LENGTH AND 1/4-KW. TRANSFORMER QUERIES.

(370.) Roy Trome, Norfolk, Va., desires to know: (1) Wave length of his aerial. (2) The dimensions and winding of 1/4-kw. transformer.

A. 1. The wave length of your antenna, which is 50 feet long with a 49-foot lead-in, is approximately 175 meters. Should you use six wires on 18-foot spreaders your wave length will be increased to about 190 meters.

A. 2. The dimensions of the sheet-iron core for a 1/4-kw. radio transformer are 10 1/2 inches long and 6 1/2 inches wide, outside measurements. The core should be 1.4 inches square. The primary should consist of six layers of No. 15 D. C. C. copper wire, and the secondary should comprise 3.7 pounds of D. C. C. copper wire wound into 17 pies, each 1/4 inch thick. The secondary is wound with No. 34 wire and has 35,000 turns. Regular transformer practise should be followed in building this transformer, paying particular attention to the insulation of the different windings.

ANCHOR GAP HOOK-UP.

(371.) Carl Menzer, Lone Tree, Ia., wants information regarding the anchor gap in connection with a looped aerial.

A. 1. The anchor gap is practically not used any longer in modern wireless stations, as it entails too much loss in the transmitting set.

Diagram is given showing how the anchor gap is used with looped aerial, and in this way, as you will perceive, the spark can jump the gaps in transmitting, while in receiving this anchor gap reduces the complexity of the switching scheme necessary

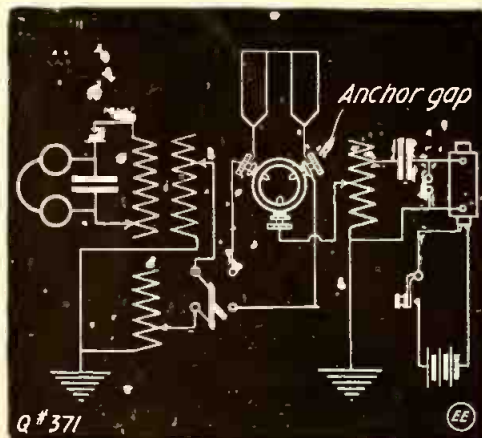

Arrangement of Anchor Spark Gap and Looped Aerial in Radio Transmitting and Receiving Set.

in throwing on and off transmitting and receiving set to the aerial.

PHANTOM CIRCUITS.

(372.) W. S. Clampitt, New Providence, Ia., inquires for a method by which he can transmit telegraph signals over a telephone circuit without interfering with the telephone transmission.

A. 1. We give herewith a sketch showing the method of accomplishing this by

means of a "phantom circuit." It is necessary to construct two coils having a comparatively high impedance. These coils may be wound on a core of soft iron wire 6 inches long and 3/4 inch in diameter, and

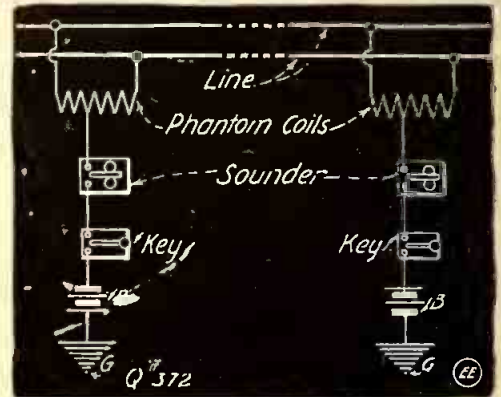

Use of Phantom Coils in Sending Telegraph Signals Over a Telephone Circuit.

consist of six layers of No. 26 S. C. C. wire. A tap should be taken from the third layer. The coils are then connected across the telephone circuit and the wire run from the taps on the third layer to the telegraph instruments; the other wire from the telegraph set is run to the ground in the usual manner, as shown.

AERIAL CONSTRUCTION.

(373.) Harry Slater, Brooklyn, N. Y., requires information on the usual method of erecting an aerial, particularly the manner in which the wires and spreaders are fastened together before hoisting to the tops of the poles.

A. 1. The usual way is to lay out the aerial wherever possible at full length on the roof or on the ground, and the two outside wires are the first ones to be secured to the insulators on the spreaders.

It is then an easy matter to connect up the other wires between the two outer ones, so that they will all be of approximately equal length and at equal tension when hoisted into position.

STATIC ELIMINATION.

(374.) Glenn Decker, Ligonier, Ind., asks us: (1) For a method of eliminating static in his wireless receiving station. (2) Why the strength of the wireless signals from N.A.A. (Arlington) change.

A. 1. We do not have anything particular to suggest regarding the elimination of static in your wireless receiving station, excepting you try one of the static preventers, such as that devised by Professor Fessenden, and you will find complete hook-up for this arrangement given in our 25-cent book entitled "Wireless Hook-ups."

A. 2. The change in strength of the wireless signals from N.A.A. is, of course, experienced regularly, and this is due to the change in temperature, or from winter to summer; the winter range of radio stations is about two to three times that obtainable in summer. From some very
(Continued on page 432.)

EXPERIMENTERS READ EVERY LINE OF THIS INTERESTING AD-

We've prepared it with care and it's written for YOU. We want you to know the Electro-Set Co. We are anxious to have you realize what we are doing to make experimenting financially possible for every live American Boy. We haven't space to tell you all—you'll have to send for our catalogues to see this. We are taking this opportunity to introduce only seven of our regular specialties and 14 wonderful bargains in odd parts such as every experimenter needs and can use. One order will convince you what the Electro-Set Co. is offering. Get in touch with us to-day.

HERE IT IS AT LAST! This 1-6 K. W. Closed Core Wireless Transformer \$6.95



After months of experimenting and after making dozens of designs and models, we have finally produced a thoroughly practical closed core transformer to retail at \$6.95, the price you formerly had to pay for spark coils and batteries. Thousands of amateurs will welcome the advent of this instrument, who either did not require 1/2 K. W. power or who did not care to spend the money for it. The transformer will send messages for twenty miles not a wild figure, but an actual fact—if a good aerial is used. Under extraordinary circumstances it will send one hundred miles. No trouble with vibrators and adjustments, reactances or resistances. Just connect the primary terminals to 110 volt, 60 cycle A.C. mains

and press key. Best silicon transformer iron is used in its construction. It will throw a heavy crashing spark that, with proper condenser, will fill a gap with a ball of white flame 1/4 inch in diameter. This comparatively small but powerful spark will send six times as far as a 1 inch spark coil. The 1-6 K. W. Transformer is another ELECTRO-SET triumph. It was thoroughly tested in one of the most complete electrical laboratories in the country by competent engineers, who pronounced it perfect for its size, in all particulars. You will be delighted with it. No. 1000 1-6 K. W. CLOSED CORE TRANSFORMER, without case, shipping weight 10 lbs. . . \$6.95 No. 1001 1-6 K. W. CLOSED CORE TRANSFORMER, in a beautifully finished mahogany case; impregnated with insulating compound and fitted with four posts; shipping weight 10 lbs. . . 9.00

Electro-Set "Navy" Loose Coupler

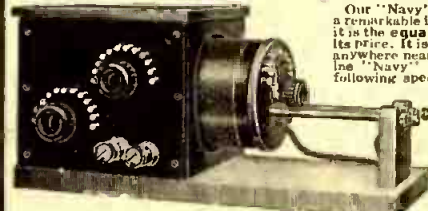

Our "Navy" Loose Coupler or Receiving Transformer is a remarkable instrument. In price it is lower and in quality it is the equal of almost any loose coupler, no matter what its price. It is certainly far superior to any we have seen at anywhere near its price. Think of being able to buy a genuine "Navy" type loose coupler at a low price with the following specifications usually only found in prohibitively priced transformers: hard rubber secondary end with large turned brass contacts; hard rubber switch panel on the front of the primary coil with twenty large, turned brass contacts; primary enclosed in a dark mahogany finished covering on all sides; every contact soldered, assuring perfect connection; handsome mahogany finished base; lacquered brass posts and trimmings. The equal of this receiving transformer can not be found. It is the acme of efficiency at moderate price.

NO. 1698 "NAVY" RECEIVING LOOSE COUPLER; shipping weight 10 lbs. \$10.00 NO. 1698 "NAVY" RECEIVING COUPLER; all wood construction. 9.00

Type "A"

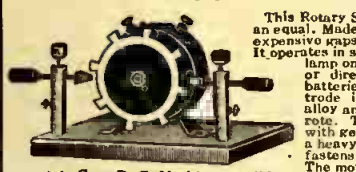

This Rotary Spark Gap is without an equal. Made like any of the more expensive gaps, but smaller size. It operates in series with a 16 C. P. lamp on 110 volt alternating current or direct current from batteries. The Rotary Electrode is of cast aluminum alloy and is perfectly accurate. The wheel is mounted with genuine hard rubber on a heavy brass bushing which fastens to the motor shaft. The motor is a K. & D. series wound A. C. or D. C. Machine, small but powerful.

This Type "A" Gap, although especially designed for our extraordinary 1-6 K. W. transformer will readily stand any good 1/2 K. W. instrument. NO. 476 TYPE "A" ROTARY GAP, shipping weight 4 lbs. . . \$5.50 NO. 477 TYPE "A" ROTARY GAP, wound to operate on 3 dry cells. 5.00 NO. 478 THREE INCH ROTARY DISC ONLY, mounted on hard rubber, with brass bushing, 1/2 in. hole, shipping weight 4 oz. 1.50

Send 4c Today

For Our

Big New Catalogue

containing description of dozens of new wireless and experimental instruments, parts and raw materials. Prices are new—instruments are new—a catalogue every experimenter MUST HAVE.

Write Today

Special Catalogues

Send 6c. in stamps for our SPECIAL ELECTRIC TRAIN CATALOGUE, illustrating scores of models. Send 4c. in stamps for our Electric Vibrator and Medical Coil Catalogue.

We Are Agents For

MARCONI USED APPARATUS

Send 5c. in stamps for new, interesting catalogue of used Marconi Wireless Instruments at ridiculously low prices. We are agents for this line and can ship promptly anything from a Type "D" Tuner to a Motor Generator.

No. 611 Aerial Switch

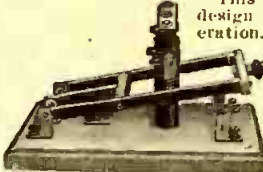

This instrument is novel in design and convenient in operation. The base is dark mahogany finish. The copper bars are 8 inches long and are sawed, not drawn. Posts are provided on all contact jaws for connections. Three posts and bars are provided on one side for the purpose either of shunting the detectors when sending or cutting off the transmitting power when receiving.

This instrument is handsome in appearance and efficient in use. Suitable for powers up to 1 K. W. NO. 611 AERIAL SWITCH, Shipping weight 5 lbs. \$2.50.

Electro-Set "Arlington-Tested" Crystals

When testing out a wireless receiving installation for the first time you want to know that your mineral crystal is sensitive. Then, too, why buy minerals on a gamble. Be sure of results—good results. Buy our "Arlington Tested" Crystals. Every one is tested for Arlington time signals. Each crystal comes sealed in a air-tight glass phial and is carefully tested before leaving our factory. Only one crystal in 20 passes our examination. Arlington Tested Crystals are the most sensitive you can procure. They are worth the price. Each one is individually examined and packed.

NO. 301 ARLINGTON TESTED GALENA, individually packed and tested; postpaid. . \$0.15 NO. 302 ARLINGTON TESTED SILICON, as above. 0.15 NO. 303 ARLINGTON TESTED BORNITE-ZINCITE COUPLE. 0.40

Electro-Set "Famous" Mineral Sets

One of the most interesting fields in wireless telegraphy is the experimenting with various combinations and methods of contact in detectors. We offer the following outfit especially designed for this purpose and packed in a neat box. Countless hours of interesting experimenting is offered to the amateur with this set. It includes five different minerals (galena, silicon, carborundum, bornite and molybdenum), each packed in a neat glass bottle; one universal detector cap; three pieces phosphor-bronze "cat whisker" wire; one polished wood detector base; one large binding post; one hard rubber knob; one rod with holder for wire. With this outfit it is possible to make many different kinds of detectors. It is ideal for the experimenter.

NO. 2100 DETECTOR MINERAL SET, as described, complete, postage paid. . \$1.25 NO. 2150 MINERALS ONLY, as above, five kinds, in bottles, postage paid. 0.50

14 EXTRA-ORDINARY BARGAINS

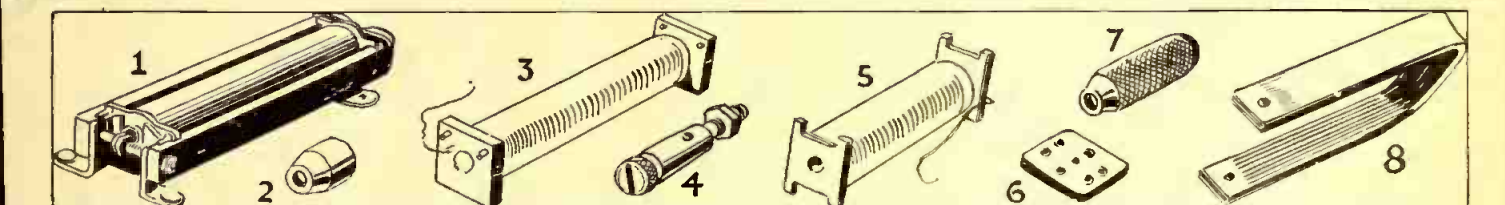

1 Polarized Ringers—New, never used. Complete with 2 high resistance magnet coils wound with silk wire and a strong permanent magnet with ringer. Worth 60c. ea. Any experimenter can use one. Special price, ea. 15c. (Postage 6c.)

2 Hard Rubber Knobs—Size 1 1/2 in. x 1/2 in. Drilled and Tapped for 6-32 screw. Handy for making apparatus. Worth 3c. ea. new. Special Price, per doz. 10c. (Postage 3c.)

3 Telephone Induction Coils—Never used. Wound to 100 Ohms with primary and secondary coils, silk covered wire. Excellent shoking coil can be made with one. Worth 50c. ea. Special price ea. 09c. (Postage 4c.)

4 Binding Posts—Handsomely nickled, 5 1/2 in. x 1 in. over all. Complete with nut. Worth 6c. ea. Special price, per doz. 25c. ea. 2 1/2c., (Postage per doz. 5c.)

5 Telephone Relay Coils—Wound to 100 Ohms with size 36 silk covered wire. Complete with soft iron core. Wire alone worth 20c. Special price, ea. 09c. (Postage 4c.)

6 Connecting Blocks—Hard rubber, size 1/2 in. x 1 in. x 3-16 in. Have 6 holes for 6-32 mach. screws. Complete with 6 screws. Worth 12c. ea. Special price 04c. (Postage 1c.)

7 Hard Rubber Handles—1/2 in. x 1/2 in. Drilled and Tapped for 8-32 screw. Worth 4c. ea. new. Special price, per doz. 15c. (Postage 3c.)

8 Toy Motor Parts—Consisting of one iron case with pole pieces; 2 covers for same and one 3-pole laminated armature with shaft. All you need is a commutator, bearings, and wire to complete motor. Above parts worth 40c. set. Special price, 15c. (Postage 3c.)

9 Here's A Dandy Chance—We have made up a number of boxes of small odd parts of electrical apparatus that every experimenter can use in his shop. These boxes each contain from 40 to 60 pieces of odds and ends, such as rubber knobs, brass standards, hooks, binding posts, screws, units, thumb nuts, coils and miscellaneous parts. Some are new—some used, but all of them are useful to have around when you are making apparatus. They are just the kind of convenient parts to be able to choose from for your experiments. We've sold hundreds of them in our retail department. Experimenters all want them. You can make dozens of things with them.

10 No. 121—Handy Assortment. Prepaid 20c.

11 75 Ohm Receiver Coils—Never used. Ready to put into any phone or to make receivers with. Wound to 75 ohms with silk wire. Worth 20c. pair. Special price, per pair, with connectors 06c. (Postage 1c.)

12 Connecting Blocks—Made of genuine hard rubber with 4 nuts and screws with connectors. Worth 15c. ea. Special price, ea. 09c. (Postage 2c.)

13 Connecting Blocks—made of genuine hard rubber with 3 handsome nickled binding posts. Useful for dozens of things about the experimenter's shop. Worth 25c. They have never been used. Special price, ea. 09c. (Postage 2c.)

14 Relay or Telegraph Magnets—In fair condition. Have been used but are in perfect shape. Wound to 80 ohms resistance. Make relay or telegraph with them. Worth 50c. pair. Special price with yoke, per pair 09c. (Postage 5c.)

THE ELECTRO-SET CO. 1874 EAST 6th ST., Dept. 110 CLEVELAND, OHIO

You benefit by mentioning "The Electrical Experimenter" when writing to advertisers.

YOUR RANGE DEPENDS ON YOUR RECEIVERS



Holtzer-Cabot Radio Receivers

have honestly
earned their
reputation of
being the

"Most Sensitive Receivers Made"

Other features are light weight, comfortable shape, durability, perfect finish. Send for Booklet 20 D2 for description.

THE HOLTZER-CABOT ELECTRIC CO.

BOSTON — CHICAGO

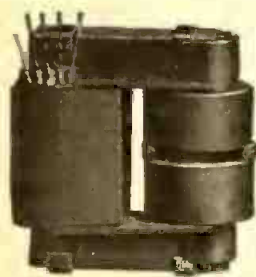

UNMOUNTED
TRANSFORMER

You Can Get Results

with a small
condenser and
this transformer

It is a 1-2 K. W. size and is built on the same specifications as to material and workmanship, etc., as our big central station transformers.

Hundreds of stations are now using these transformers. This transformer gives you 13,200 volts.

Let us tell you how you can do part of the work yourself and get this transformer at a remarkably low cost.

THE PACKARD ELECTRIC CO.
555 Dana Avenue Warren, Ohio

BOSTON WIRELESS

Boston Receiving Transformer, \$7.50
Variable Condenser, 25 Plates, \$2.75
Boston Detectors, \$1.00, \$1.25, \$1.75, \$2.25, \$4.00

Agent for Electro Importing Co. and A. W. Bowman Co., Manhattan and Adams Morgan Spark Coils, Ever-ready flash lights and batteries. Catalog for stamp only.

M. MUELLER, 18 Devonshire Street, BOSTON, Mass.

QUESTION BOX. (Continued from page 430.)

exhaustive tests extending over a period of a year and more and presented in the Institute of Radio Engineers' "Proceedings" of a recent date, this summer range has been found for ordinary ship radio stations of the spark type to quite regularly be only equivalent to one-tenth the winter range.

REGARDING QUENCHED SPARK GAPS.

(375.) Frank Zacharia, Jr., N. S., Pittsburgh, Pa., desires to know how many pairs of gap plates are required for a 1/2-kw. and a 1-kw. wireless transformer.

A. 1. The number of pairs of plates required for the Telefunken gap depends upon the discharge voltage of your condensers. The general practise is to allow 1,000 volts to each gap. Thus, knowing the voltage of the transformer secondary or the discharge voltage of the condensers, it is very easy to calculate the number of gaps required. You understand that the more power there is used the larger the gap surface must be to prevent overheating of the gap.

ELECTRO-MAGNET DESIGN.

(376.) Charles Malcolm, Jr., Philadelphia, Pa., requires information: (1) As to relation between the size of a wire on a magnet and its lifting power. (2) Data for the construction of an electro-magnet to exert a force of one pound at a distance of 6 inches.

A. 1. It makes practically no difference what size of wire is found on an electro-magnet if the proper voltage is used in conjunction with same. That is to say, the same number of ampere turns will go in a given space, roughly speaking, if the voltage and current are properly balanced out, so that the coil will not overload. This, as you will perceive, is merely a matter of electrical design and calculation.

A. 2. Your problem for designing an electro-magnet to exert a force of one pound at a distance of 6 inches is rather out of the ordinary, and it would require a very powerful magnet coil to do this work. Possibly, however, your problem can be solved efficiently by the use of a properly designed solenoid or suction type electro-magnet. However, it does not seem practical to build a regular type electro-magnet to exert any such pull as you mention over the range of action specified.

INSULATION AND DETECTORS.

(377.) C. Russell, London, England, asks: (1) The best dielectric or insulator for high-frequency apparatus. (2) Several questions regarding the de Forest Audion and Fleming valve detectors.

A. 1. The best substance now available is that known as Bakelite Di-Electo. This is used by the Marconi Wireless Telegraph Co. for its panels on wireless receiving cabinets, and therefore can be considered as probably one of the best substances available at this time for the purpose in question.

A. 2. The Audion detector is supplied in America by the de Forest Radio Telephone & Telegraph Co., which manages practically all sales for this detector in this country, and it is, of course, supplied by various dealers. However, no independent companies make a detector similar to the Audion insofar as we are aware.

The Marconi Co. supplies the Fleming valve, but this is said on pretty good authority to be inferior to the Audion.

WIRELESS TELEPHONE QUESTIONS.

(378.) M. A. Norgren, Springfield,

Mass., sends us a sketch of a wireless telephone transmitter and wishes to know: (1) If this set would work. (2) If not, why not? (3) Will the 6-volt 40-A.H. and 8-volt 80-A.H. storage cells be powerful enough, and how far will it work?

A. 1 and 2. To all appearances your apparatus will not work because you have the secondary of the 1-inch spark coil inserted in the high-frequency circuit, and the high impedance of this coil will prevent pure oscillations taking place.

A. 3. We cannot say whether the storage batteries you are using would be powerful enough for a wireless telephone, but an ideal set of this type should operate on such small storage batteries. We would like to say here that for a satisfactory wireless telephone it is necessary to obtain undamped oscillations in the closed oscillatory circuit having a frequency value of at least 30,000 per second, which is above audibility. It is impossible to obtain this frequency with an ordinary vibrator, and

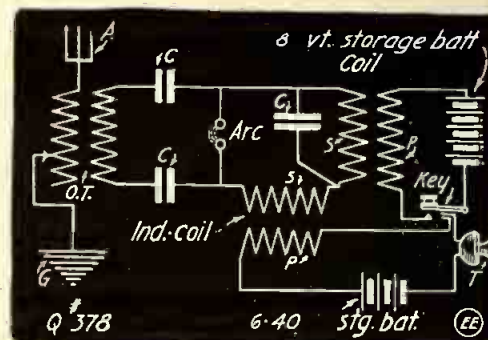

Proposed, But Impractical, Radiophone Hook-Up.

for this reason spark coil sets have never worked satisfactorily over very long ranges and the enunciation in every case is very poor.

THE AURORA BOREALIS.

(379.) Lawrence Madison, Kingman, Me., writes us stating that he has personally seen the Aurora Borealis from his home in Maine and that a distinct hissing sound was noticeable. This is contrary to the statements in the article entitled "The Aurora Borealis, or Northern Lights," which appeared in the October issue of *The Electrical Experimenter*, and he wishes an explanation.

A. 1. It seems reasonable to suppose, and especially if we consider the Aurora Borealis an electrical phenomenon, that there may be a noise or sound produced by such a display. We have, however, checked up this matter quite carefully in preparing the article, and in all cases which came to our attention and wherever this sound theory or statement was made, it was invariably refuted by different authors and authorities on the Aurora Borealis. One of the best works on the subject is that by Alfred Angot, and while many statements are quoted therein from various people to the effect that they had distinctly heard sounds when the Aurora Borealis effect took place, the authorities on this matter give an explanation about in line with that mentioned in the article referred to.

This same idea, advocating the "no sound" theory with regard to the Aurora Borealis, is concurred in by Henri Arctowsky, a well-known authority on this phenomenon and a scientist who has passed many years exploring the Northern and Southern Polar regions. This does not, however, purport to infer that your ideas or statements are not correct, and, as yet, we can truthfully say that the Aurora

(Continued on page 434.)



"EVERYTHING FOR THE EXPERIMENTER" IN THIS "THE LIVEST CATALOG IN AMERICA"

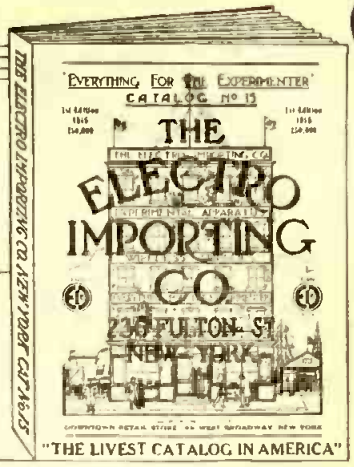

THE ELECTRO IMPORTING COMPANY CARRIES THE LARGEST STOCK OF EXPERIMENTAL, ELECTRICAL AND WIRELESS GOODS IN THE WORLD. We are the originators of the Wireless Experimental business in the U. S., selling the first wireless outfit in 1904. Our wonderful facilities enable us to give you delivery in 24 hours. WHEN ORDERING GOODS FROM THIS PAGE ENCLOSE POSTAGE ELSE GOODS MUST BE SHIPPED BY EXPRESS COLLECT. The goods shown here are only a small part of our entire line which is fully described in our 275-page Cyclopedic Catalog, which weighs 1/2 lb., is 6 3/4 x 5 1/4 inches in size and contains 2,000 articles, 658 illustrations, 30 diagrams and tables, full Morse Continental and Navy Code Charts, besides "Treatise on Wireless Telegraphy," list of call letters of all U. S. Gov't and Commercial ship and shore stations. This wonderful Cyclopedic sent free if you send us 4c, in stamps or coin to cover postage only. WE SELL MERCHANDISE, NOT CATALOGS. "Why buy Catalogs when the best is free?" Use coupon below to send for Catalog, enclosing 4c, for postage only.

Grid of 6 items: 2392 Boy Scout Knife, 2422 Upright Caloric Engine, 3418 Smallest Flashlight Made, 1119 Telegraph Key, 1550 Inter-Ocean Wireless Receiving Outfit, WIRELESS DETECTOR.

Grid of 6 items: 2365 Rugby Football, 810 Dynamo, 5000 Rheostat, Porcelain Base, 5707 X-mas Tree Lighting Outfit, 100 Hustler Motor, 7199 Revolver Flashlight.

Grid of 6 items: 16003 Electric Lighting Outfit, 3356 Radio Nitrogen Battery, 1331 Dynamo, Free Wireless Course, 1024 Telephone Receiver, 1547 "Presto" Hand Lamp.

Grid of 6 items: 2420 Upright Steam Engine, 5602 Trolley Car Outfit, 4300 Pocket Ammeter, "Presto" Bicycle Lamp, 1088 Spark Coil, 3352 Printing Press.

THE ELECTRO IMPORTING COMPANY

"EVERYTHING FOR THE EXPERIMENTER" 236 FULTON STREET, NEW YORK

Write your name and address in the Margin below

CRYSTALOI

THE NEW-BB-

The New Type -BB- CRYSTALOI is a SUPERSENSITIVE Detector comprising every accessory and refinement in A SINGLE UNIT

It consists of a highly finished African mahogany case in which is located a super sensitive Crystalol cylinder of which the periphery protrudes through the top making it accessible for rotating to secure finest adjustment. A cohering inductance especially calculated and calibrated to the super-sensitive cylinder. A fixed condenser with the exact capacity for this particular cylinder. A specially wound Buzzer of which the frequency is controlled by a knurled screw head mounted on the front of the case to produce a note that is best suited to assist in cohering the alloy in the cylinder. Two of the highest grade dry batteries to operate the Buzzer and a Buzzer control button which protrudes through the top of the case for accessibility.

With this carefully designed and calibrated instrument you have but to set it on the table, connect your phones and leads from your tuning coil and you are permanently and thoroughly equipped to engage in the most serious wireless work of the present day. Of course Variable Condensers can be added if desired.



Dimensions $7\frac{1}{2} \times 5\frac{1}{2} \times 3\frac{1}{2}$ high
Mailing Weight 3 Pounds. Price **\$12.00**

— Other Types of the Crystalol —

CRYSTALOI TYPE O
Very Sensitive

CRISTALOI TYPE AA, Super Sensitive
TWENTY-ONE HUNDRED MILES
IS THE LATEST CRYSTALOI RECORD

CRYSTALOI
A PERMANENT WIRELESS DETECTOR THAT HAS MADE A WONDERFUL RECORD

You will find wireless men on land and sea using Crystalol Detectors in preference to any other detector made. They will not burn out or go dead and are ever ready to pick up the minutest currents that are in the air. They are sold under the Turney guarantee and are making their wonderful reputation on real merit. Send today for full description.



Dimensions $2\frac{1}{4} \times 1\frac{1}{2}$ in.
Mailing Weight 1 Pound.
PRICE, \$3.50.

ORDER A CRYSTALOI TODAY AND STOP YOUR DETECTOR TROUBLES



Dimensions $4 \times 3\frac{1}{2}$ in.
Weight 2 Pounds. PRICE, \$6.00.

OUR WIRELESS ACCESSORIES

THE NEW TURNEY VARIABLE CONDENSER



Dimensions: $5\frac{1}{2} \times 2\frac{1}{2}$ in. Made in two capacities.
Type X—35 Plates. Price \$3.50.
Type XX—50 Plates. Price \$5.00.
ORDER ONE NOW
and see what you have been missing.

The New Turney Variable Condenser meets all the requirements of the most exacting wireless man inasmuch as it has more capacity for its size than any condenser ever made. The great advantage lies in the fact that it is provided with round plates of a special alloy $1\frac{1}{2}$ in. in diameter, of which the entire area is available for condensing purposes. This you will find in no other variable condenser.

The New Turney Variable Condenser possesses an absolute zero. This you will find in no other type of condenser. The plates are enclosed in a flint glass tube on which the scale is engraved. It is air and dust-proof and can not get out of order. The dielectric is air, therefore the efficiency is the greatest possible. The ends are of hard rubber composition and are highly finished. A hard-solder and more valuable wireless instrument you never saw.

SEND FIVE CENTS IN STAMPS FOR COMPLETE CATALOG

THE TURNEY ROTARY LOADING-COIL



Dimensions $3\frac{1}{2}$ in. \times 1 in.
Price \$3.50.
Mailing Weight One Pound.

When used with the ordinary loose-coupler will give a total capacity of about 4,600 meters. The entire instrument is of hard-rubber composition. The blade is of a silver alloy, which insures the maximum efficiency. The rotary coil has a knurled edge and is provided with a scale divided into sixteen equal divisions.

CONSTANT AMPLITUDE TEST BUZZER



CONSTANT AMPLITUDE TEST BUZZER
Dimensions $2\frac{1}{4} \times 2\frac{1}{2}$ ins.

Our special Constant Amplitude Test Buzzer contains some entirely new features and gives a smooth, even tone at all times. This is due to the arrangement of the contact which is provided with a lenient hack-check. The contact points are of pure silver, which prevents burning, and the entire mechanism is enclosed in a non-resonant dielectric case. PRICE, 75 CENTS
Include 10 Cents extra for postage. Remit in form of P. O. or Express Money Order.

QUESTION BOX.
(Continued from page 432.)

Borealis effect is really but very little understood, even by our foremost men of science.

DIMENSIONS OF $\frac{1}{2}$ -KW. STEP-DOWN TRANSFORMER.

(380.) John Burkitt, Madoc, Ont., Canada, asks us for the dimensions of a $\frac{1}{2}$ -kw. transformer to change 220 volts to 110 volts alternating current.

A. 1. The dimensions of the $\frac{1}{2}$ -kw. transformer for changing 220 volts to 110 volts are as follows: Core, outside dimensions, 14×7 inches and 1.4 inches square. Primary windings consist of 625 turns of No. 16 D. C. C. or enameled wire, and the secondary requires 312 turns of No. 13 wire. Three pounds of the No. 16 and $2\frac{1}{2}$ pounds of the No. 13 will be sufficient for you to wind the transformer. It can be constructed in the usual manner and connected direct to the 220-volt mains. It will consume 2.5 amperes and will deliver 5 amperes at the secondary terminals. The iron core should be made of transformer iron and particular attention should be paid to the insulation.

OPERATION OF ROTARY GAPS.

(381.) Walter Franseen, Woodhull, Ill., desires to know: (1) If the "Multi-Audi-Fone" and the "Multum in Parvo" instruments are fully up to the claims made by the manufacturers. (2) Several points regarding the operation of a rotary spark gap.

A. 1. The "Multi-Audi-Fone" and the "Multum in Parvo" instruments are fully up to the advertiser's claims. *The Electrical Experimenter* does not carry any questionable advertisements in any sense of the word. We do not know the patent number on these instruments. However, you could, no doubt, find this out by communicating directly with the United States Patent Office, Washington, D. C., or with the manufacturers themselves.

A. 2. Your question regarding the rotary spark gap is not entirely clear, as most of the rotary gaps, to our knowledge, are of the one type. Perhaps you refer to a gap with two breaks; the number of breaks has little or no bearing on the matter, and the only effect obtained is an increase in the quenching effect. It is, of course, necessary to run the rotary gap so it sparks at the peak of each cycle of the A. C. for synchronism. This would give you 120 sparks per second on 60-cycle current. Non-synchronous gaps have been used with more or less success, particularly the Marconi type, which gives 240 sparks per second. To increase the tone of a spark gap, that is, to operate the disc at a higher speed, it is necessary to change the capacity of the condenser in the closed oscillating circuit for highest efficiency, the capacity being smaller the higher the spark frequency.

DOES A TUNER "KILL" SIGNALS?

(382.) "Experimenter," Georgetown, Tex., writes us inquiring how wireless signals pass through a tuner when the "curls" of the wire used in some electric connections have the effect of choking the signals, as we well know.

A. 1. A high frequency current flowing in a circuit similar to a circuit used in radio work requires that a certain amount of the inductance capacity should be in that circuit to prolong the oscillations, the turns of wire in the tuner acting as the inductance and the elevated aerial as the capacity. When these are properly adjusted the circuit is in tune and the incoming wave currents flowing in the circuit will be at their

Eugene T. Turney Company, Inc., 2595 Third Avenue
NEW YORK CITY

maximum. Should any small coils be inserted in the connections it adds that much unnecessary inductance, which is of no use usually and the added impedance causes the current to be reduced in value, owing to the circuit being thrown out of tune, or to the increase in resistance (damping).

HYSTERESIS IN CONDENSER.

(383.) Jeter Pinkston, Valdosta, Ga., asks: (1) What is the standard formula for the solution in storage cells? (2) Is a high potential current a high voltage current? (3) What does hysteresis mean when used in the description of a variable condenser that is losing energy due to hysteresis? Also which is better to use in a variable condenser, oil or air?

A. 1. The standard solution used in storage cells is a mixture of 1 part of sulphuric acid to 5 parts of water. This should be mixed in an earthenware container and constantly stirred. Don't fill cells until solution has cooled.

A. 2. A high potential current is one having a high voltage.

A. 3. Hysteresis loss here is the loss in the dielectric of the condenser. The plates of the condenser are constantly charging and discharging; thus the stress between them is constantly changing its direction. This change of stress has the effect of heating the dielectric and a small amount of the current is lost in this manner.

For high efficiency a variable condenser should use air as a dielectric, but oil increases the capacity and also the hysteresis loss somewhat, as mentioned in your question.

RADIO RECEIVING TIKKERS.

(384.) H. P. Keiffer, Lebanon, Pa.,

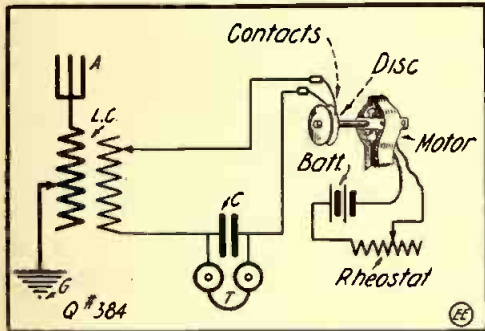

Undamped Wave "Tikker" Hook-Up.

asks: (1) Is it possible to receive stations using undamped waves with a Radioson, electrolytic, or mineral detector? (2) Can a copper disc be used in constructing a tikker and what is the location of the contact springs? (3) The hook-up for the tikker, using a loading inductance and tuning coil or loose coupler?

A. 1. It is only possible to receive undamped wave stations with an ordinary detector when the sending apparatus gets slightly out of tune, resulting in slightly damped waves. The tikker is necessary for all around work in the reception of undamped waves.

A. 2. Any metal can be used for constructing the disc of the tikker and the two springs can lay in the groove about one-half inch apart. The disc may be 2 inches in diameter, and a rheostat should be used to control the speed of the motor. The faster the motor is driven the higher pitched note will be as heard in the 'phones.

A. 3. Hook-up is given herewith for a tikker, and no detector is used in the circuit with this instrument ordinarily.

IS MUNCHHAUSEN AT IT AGAIN?

(385.) R. E. Breunig, Chicago, Ill., asks several questions regarding a peculiar phenomenon that occurred in the neighborhood (Continued on page 437.)

Multi-Audi-Fone

The new wonder in the wireless world. It increases the Audibility 1,500 Times

Read What Others Say

Messrs. Stickel & Stickel, of Connellsville, Pa., say: "We have given your apparatus a thorough test and find that they are all that you claim them to be."

Mr. D. L. Irvin, of Curwensville, Pa., says: "I was surprised with the results from it. Arlington and several other stations came in so loud that I could read them with the 'phones ten feet from my head."

Mr. Ralph Batcher, of Toledo, Iowa, says: "The results were even more than were expected, both at the convention and by other amateurs in Des Moines, who tested the apparatus, and other places."

Mr. John Tucker, Jr., of Elizabeth, N. J., says: "After a thorough trial, am astonished at the results obtained. Combining, as these instruments do, the greatest degree of efficiency coupled with extreme compactness, they are, without doubt, the finest instruments offered to the amateur and professional wireless field at large."

W. O. Horner, of Cleveland, Tennessee, says: "I have been trying your Multi-Audi-Fone out as an Amplifier. I was more than surprised at its sensitiveness. It is certainly wonderful. I stood at the rear of my store, one hundred and twenty-five feet from 'phones, and copied Arlington and Key West, also Tampa, Florida. I consider that some amplifying for way down here on Inland."

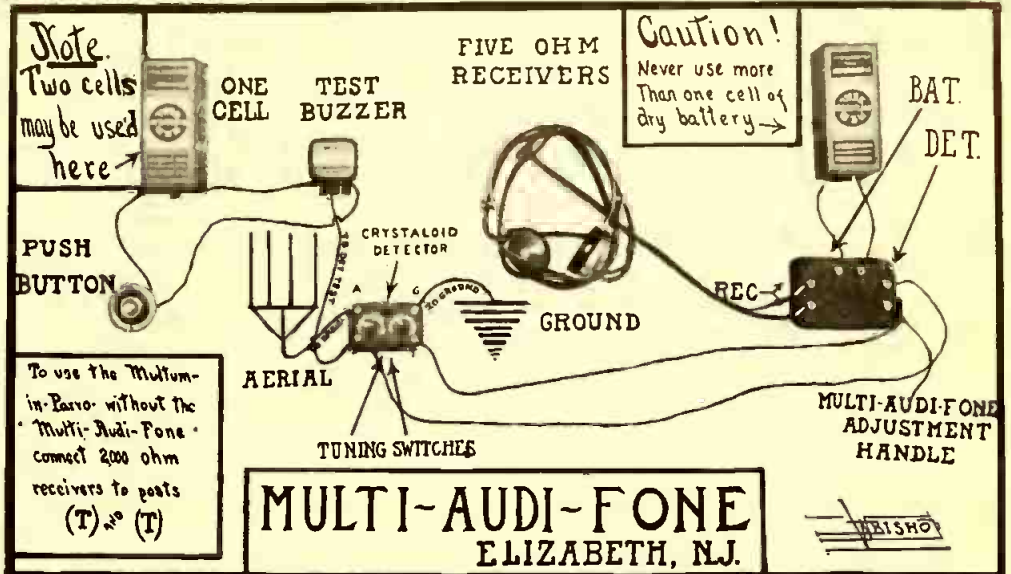

Note: Two cells may be used here

Caution! Never use more than one cell of dry battery

To use the Multum-in-Parvo without the Multi-Audi-Fone connect 2000 ohm receivers to posts (T) & (T)

MULTI-AUDI-FONE
ELIZABETH, N.J.

Multum in Parvo Receiver, including Crystalloid Detector and Buzzer - \$20.00
Multi-Audi Fone, including our Specially Wound Head Set - \$30.00
The Matchless Christmas Present. Our Complete Wireless Set, Only \$50.00

Talking Multi-Audi-Fone

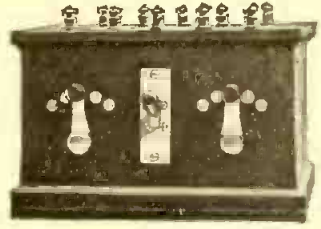

Size, 4 1/2" x 5" x 7".

The amplification is so great with the Talking Multi-Audi-Fone that the signals can be read all over the five-story building from our laboratories, which are located on the third floor. If the windows are opened, the signals can be heard across the street, even when the trolley is passing.
Price, including horn \$100

Telephone Voice Multiplier

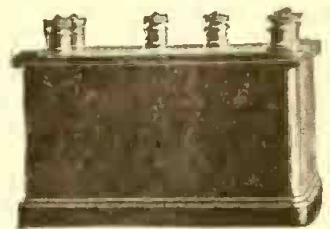

Size, 2 1/4" x 3 1/4" x 4 1/2".

The Telephone Voice Multiplier has been made possible by applying the principle employed in our Multi-Audi-Fone to the telephone receiver. The voice can be distinctly heard coming over 1,000 or even 2,000 miles of wire that would be indistinct coming over 100 miles of wire. Buy a Multiplier and stop straining to get something you can't bear. Price \$15.00

Send for circular to-day **MULTI-AUDI-FONE** 273 Morris Ave. ELIZABETH, N. J.
Ask your dealer to-morrow

BUY NOW—SAVE MONEY

WIRELESS XMAS SALE

BARGAIN PRICES TO PROVE the wonderful values and superior goods we give you direct from our factory. These ridiculously low prices are only made possible by our enormous output for our tremendous trade. All highest quality—beautifully made and thoroughly tested out.

Save 25% If You Act Now

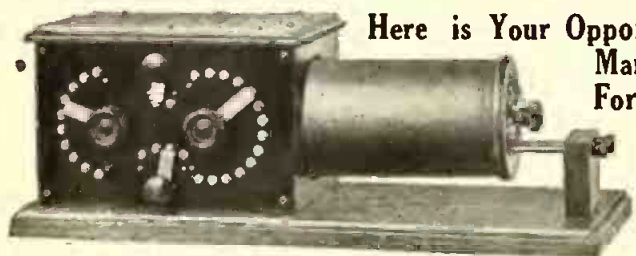

Here is Your Opportunity to Secure the Best Navy Type Loose Coupler on the Market. Regular Price - - - - \$15.00 **\$10.00**
For December Only—Reduced Sale Price - - - -

A brass lacquered 6,000 meter inductance tuner, perfect in every detail. Equipped with four point loading inductance which increases the wave length 4,000 meters over the average Navy Type Transformers. The primary winding has 24 taps—one switch controls the primary in groups of ten, the other controls one turn at a time—and is equipped with a dead end switch. Enclosed in a cabinet, the front of which is polished hard rubber. The secondary coil is wound with double silk covered wire and the inductance is varied by a ten point switch. With this coupler the very finest and most accurate tuning is easily and quickly secured. With a good sized aerial the reception of wave lengths up to 6,000 meters is possible.

All Finished Parts Ready For Assembling With Full Instructions - - - \$6.50

Our No. 810 Complete Sending and Receiving Station

Sends up to 12 miles.
Receives up to 1,000 miles.

Regular Price \$20.00
For December Only **\$14.00**
—Sale Price

Full 1 1/4 inch coil type. Sends up to 15 miles. Receives up to 1,000 miles under favorable conditions. Equipped with 2 double pole 1,000 ohm receivers, 6 feet silk cord and double headband. Size of base 12 x 16 inches, height 13 inches, weight only 14 pounds.

This is a completely equipped and thoroughly reliable station, mechanically and electrically perfect and ready for instant service. Nothing better in this class was ever constructed. The new improved tuning coil enables you to tune in or tune out any party you might desire, thus eliminating any interference. The set consists of a 1 1/4 in. Spark Coil, 12 Flat Plate Condensers, our "Don't Jar Out" Detector, Buzzer and Switch to tell if your detector is working. Double Slide Silk Wire Wound Tuner for long wave station capacity. Fixed Condenser Helix, Key, DPDT Switch and complete 2,000 Ohm Headset.

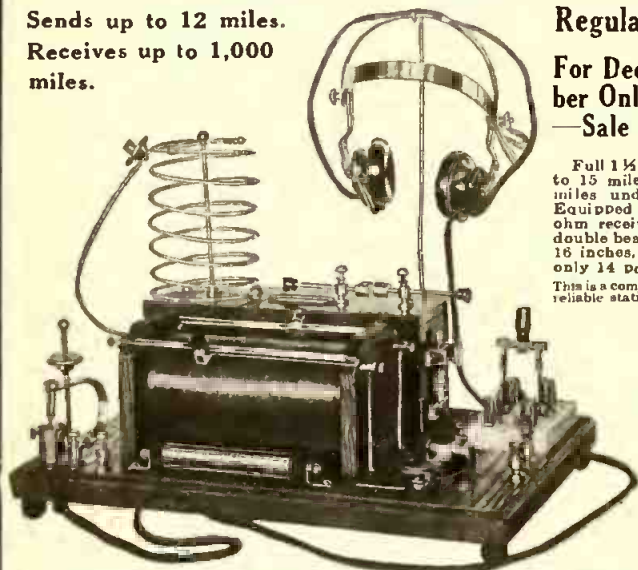

Receive The Time From Arlington

AND ALL NEWSPAPER AND SHIP REPORTS
OUR SPECIAL TIME SIGNAL RECEIVING OUTFIT **\$8.10**
REGULAR PRICE \$10.85—SALE PRICE

This is our new 1915 model made of the highest grade material obtainable. Double slide coupler for close tuning is wound with No. 24 green silk covered wire on the primary—the secondary with No. 28. There are 8 points to divide its capacity. A 3,000-metre loading coil placed between the coupler and the aerial by a switch that throws it in or out of the circuit enables you to receive amateurs with the coupler alone and long wave stations by the addition of the loading coil. One fixed condenser of proper capacity, improved universal detector, one huzzer test to test your mineral and potentiometer. This instrument is assembled on a highly finished oak base. All metal parts are heavy nickel-plated. This station, with our Navy Type Loose Coupler, as illustrated above, \$15.00

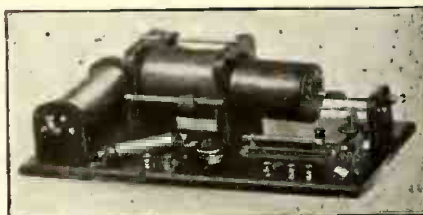

OUR No. 401 SENDING AND RECEIVING STATION

Regular Price \$5.95
For December Only—Sale Price **\$4.95**

Sends up to 3 miles. Receives up to 300 miles.

Consists of 1/4-inch coil, fluted end spark gaps, four plate secondary, one collapsible helix, one key, a two-slide tuner, fixed condenser, detector and buzzer test to test your mineral. This set is mounted on a highly finished oak base with all metal parts heavy nickel-plated. With a good-sized aerial, under favorable conditions, will send up to 3 miles and receive up to 300 miles.

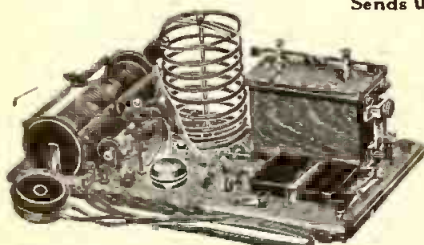

FREE!
Complete Gem Station

Receives up to 300 miles. We will give absolutely free a Gem Outfit to every one who sends us the cost of the

necessary equipment for it. This equipment consists of:

2000 Ohm Headset	\$3.95
16 Insulators	.48
1 Ground Clamp	.10
500 Ft. of A-1 Wire	1.20
20 Ft. of Rubber Cable for lead in	.90
TOTAL	\$6.63

Send \$6.63 at once and we will include the Gem Receiving Station Free. A splendid outfit for beginners.

Send 6c. in Stamps for Our Big 152 page Wireless and Electrical Catalog "H-80" Containing Hundreds of Wonderful Bargains of All Kinds FREE—Send for Big Electrical Toy Catalog. Save Money Xmas.

Nichols Elect. Co., 1-3 W. Broadway, N. Y.

Manufacturers of Standard Quality Goods Only

FREE—Write our QUERY DEPARTMENT. H-80
For free technical advice on all wireless questions send this coupon, with letter, to NICHOLS ELECTRIC CO., 1-3 West Broadway, New York.

QUESTION BOX.

(Continued from page 435.)

of Chicago from the 14th to the 18th of September last, when the wireless detector would go "dead" and no amount of adjusting would bring in any signals. He writes, however, that by reversing the connections to his detector it would be put into operation again. (2) When a rheostat or potentiometer is used to regulate the brightness of a lamp does the same amount of current flow from the battery whether the lamp burns bright or dim? (3) How does a Radioson work?

A. 1. We cannot think of any reason for the peculiar action of your detector, except that strong static currents may have been the cause; to the best of our knowledge Baron Münchhausen had nothing to do with it!

A. 2. As the resistance in the circuit determines the amount of current flowing through the circuit, increasing the resistance will decrease the current drawn from the battery.

A. 3. The Radioson detector is constructed on the principle of the sealed-point electrolytic device of this class. This detector at one time was thought to act on the drop of resistance principle, but later researches prove it to be a pure rectifier. See "Principles of Wireless Telegraphy," by Prof. George W. Pierce, where this matter is exhaustively treated upon, accompanied by actual rectifying oscillograms.

OPEN CORE TRANSFORMER ON D. C.

(386.) B. Tilden, Brookfield, Ill., writes us asking: (1) How an open core transformer can operate on D. C., having seen one working under these conditions. (2) Instructions for making a closed core transformer from a 2-inch coil.

A. 1. The fact that the transformer operated on a D. C. generator indicates that the commutator on the dynamo was in very poor condition, creating distinct breaks or bumps in the current. This would cause the transformer to operate the same as a spark coil on an interrupted primary current, but the efficiency is very low.

A. 2. A closed core transformer can be made from a 2-inch coil by constructing a rectangular frame of thin transformer iron and winding on one leg three layers of No. 16 D. C. C. copper wire and mounting the secondary of the 2-inch coil on the other leg. The input will be about 250 watts, and you should place a choke coil in series with the primary to control the current.

ARC TRANSMITTER FOR RADIO.

(387.) Edward D. Fitzpatrick, Wilson Park, Tarrytown, N. Y., requires (1) a

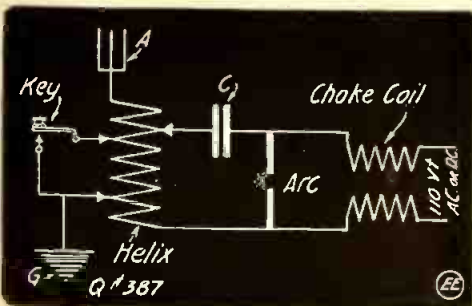

Arc Used for Radiophony.

hook-up for transmitting set using an arc. (2) Why does the note of a sending station become louder when the rotary gap has stopped and while the last few letters are being sent?

A. 1. The sketch herewith shows the

The Famous DE FOREST AUDION

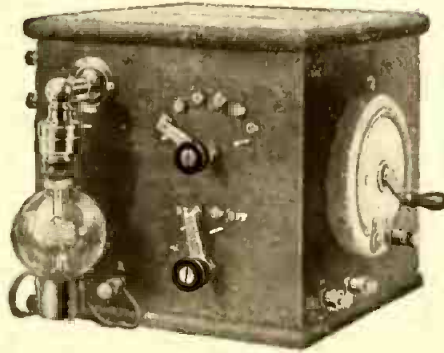

Type R. J5 De Forest Audion Detector

It remains in adjustment ALWAYS, and is guaranteed to be MORE EFFICIENT, and MORE RELIABLE than ANY OTHER detector ever offered for private use. Price, \$25.

THE DE FOREST AUDION AMPLIFIER

is used in connection with any detector, preferably a De Forest Audion Detector, to increase the intensity of received signals from 5 to 10 times (actual, not theoretical) per step. Constant and reliable, as all other De Forest Audion Apparatus. Brings in stations otherwise inaudible, ALWAYS. Price, \$65, and worth it.



Type PJ1 De Forest Audion Amplifier

WARNING

Vacuum Bulbs, having a filament and two electrodes, as well as a number of other types, are protected under a large number of BASIC PATENTS, issued to Dr. Lee de Forest, and owned or controlled by this company.

All infringers will be prosecuted to the full extent of the law. DE FOREST AUDION APPARATUS is sold by all the large reliable wireless supply houses and is carried in stock by most of them. ORDER FROM YOUR REGULAR DEALER, or from us if you prefer.

Bulletins giving complete descriptions sent if you enclose stamp

De Forest Radio Telephone & Telegraph Co.
101 Park Avenue, New York, N. Y.

Winger's Closed Core Transformers

14,000 VOLTS
Perfectly Insulated.

3/4 K.W.	\$10.75
1/2 K.W.	15.00
3/4 K.W.	20.50
1 K.W.	25.50

Designed for direct connection, 110 volts 60 cycles without resistance or impedance. Send 6c. for big new catalog.

Winger Elec. & Mfg. Co.
711 So. Dearborn St.,
CHICAGO, ILL.

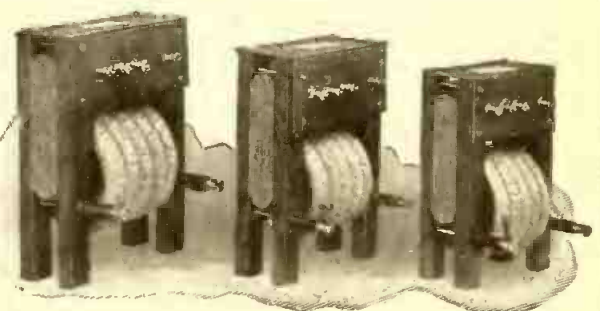

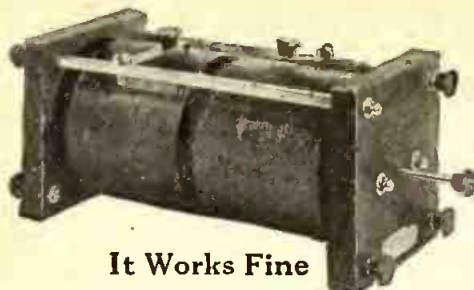

It Works Fine

"Your Receiving Transformer certainly works fine. It brings signals in louder than any other tuning device I have ever used. N. L. Goggin, Jr., Cazenovia, N. Y." Price only \$5.00. Send two-cent stamp for bulletin 105.

Colby's Telegraph School, Auburn, M. Y.

LOOK! A NEW CHAMBERS COUPLER No. 744, PRICE ONLY \$4.50

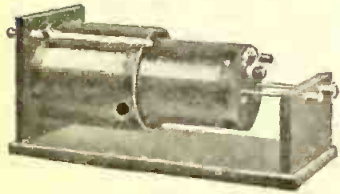

Positively unequalled for the money. Is 6" high, 6" wide, and 14" over all. Wound with Enamelled wire, and has a very unique slider. Wood-work mahog-

any finished. Try one, you will not be disappointed.

5c. in stamps brings our 64-page illustrated catalogue, B-B-24. None otherwise.

F. B. Chambers & Co. 2046 Arch Street Philadelphia, Pa.

method of wiring an arc for radio transmitting purposes. With this apparatus you will be able to cover quite a long distance, but it will be necessary to use a tikker or audion "beat" circuit at the receiving station.

A. 2. The only reason we can give to explain why the note from a transmitting station increases in intensity when the rotary gap stops is as follows: The diaphragm in the receiver has a certain natural period of vibration, and this may be approximately tuned to the low frequency of the note when the rotary gap is stopped. Your receiver diaphragm does not vibrate fast enough to be in synchronism with the group frequency of the transmitting set when the gap is running, therefore it does not give the loud note noticed when the two are nearly at the same pitch.

MAGNETIZING COILS.

(388.) Young Experimenter, Buffalo, N. Y., wishes to know: (1) Where he can obtain a battery type magnetizer of the Swedish-American type? (2) If distilled water can be used instead of rain water in mixing solution for silver plating, and if rain water is a chemical or naturally pure solution?

A. 1. You can no doubt purchase a battery type magnetizer of the Swedish-American type from the Swedish-American Telephone Co., located in Chicago, Ill.

A. 2. Rain water is condensed moisture from the atmosphere and contains no alkali, but has several impurities in it, such as dust and traces of various acids found in the air. Distilled water can be used in mixing plating solutions instead of rain water, as they are both practically pure, but not chemically pure.

PERPETUAL MOTION.

(389.) George Haller, St. Louis, Mo., asks us: (1) Has any perpetual motion machine ever been invented that will deliver power? (2) How do aeroplanes obtain a "ground" for wireless work?

A. 1. No one has succeeded in inventing a practical perpetual motion machine as yet, and such an invention would entirely upset all our present basic laws of physics and energy.

A. 2. Aeroplanes obtain a ground by dropping a wire 100 or 200 feet long from a reel, and they use wires strung from the tail to the wing-tips for an aerial.

WAVE LENGTH OF COUPLER.

(390.) Nels Erlandson, Chicago, Ill., desires: (1) A formula to calculate the wave length of loose coupler. (2) A tuning coil. (3) Whether a carborundum detector requires a battery potentiometer.

A. 1 and 2. A rough method of determining the wave length of coupler or tuning coil is to calculate the length of the wire on the coil, primary only, in the case of the coupler, and multiply the length of this wire in feet by 1.5, which will give approximately the wave length in meters. For further data on this we refer you to the September, 1914, issue of *The Electrical Experimenter*, in which appeared an article entitled "Loose Couplers and Their Wave Lengths"; also to the numerous publications procurable at small cost from the Bureau of Standards, Washington, D. C., which give exact mathematical formulas for calculating self and mutual inductances of coils of various sizes and diameters of wire used in radio practise.

A. 3. For the best results with carborundum detectors a critical adjustment of the voltage applied to it is required and it will be necessary to use a potentiometer with battery for this purpose.



FRANCO FLASHLIGHTS

are ideal for use by electrical experimenters. The Fibre case lights have a patented wireless feature which absolutely prevents their short-circuiting under any conditions whatsoever. The nickel plated lights won't short-circuit, either, and are not affected by oil or moisture.

"Franco" flashlights are quality flashlights; equipped with our Radio Battery they give more light than any flashlight on the market. They are definitely guaranteed to give you real satisfaction and service. Among the many different styles you are sure to see the one you want.

Prices are very reasonable.

See your dealer's assortment, or if he hasn't got the genuine "Franco" flashlights, write us for an interesting catalog, No. 9.

INTERSTATE ELECTRIC NOVELTY CO.
29 Park Place
NEW YORK

CHICAGO
SAN FRANCISCO
TORONTO

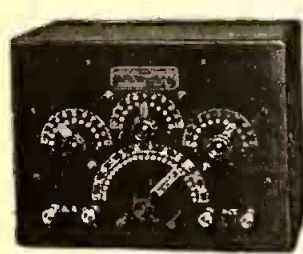
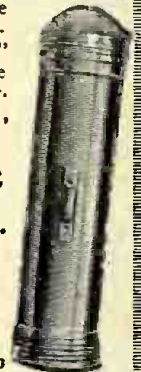

"Mignon-System"

Patents Applied for

R C 2
\$20.00

A Marvel in Selectivity and Efficiency.

The Last Word in RADIO-APPARATUS.

Write for Literature

SIZE 12 1/2 x 9 1/2 x 6 INCHES

MIGNON-WIRELESS CORPORATION
Specialists in Radio Signal Receiving Apparatus
127 W. Market St., ELMIRA, N. Y.

"MONOTONE" QUENCHED SPARK GAP

It is new! Wonderfully efficient. Hear what the operator at the distant receiver will say about your new "spark." In single units for small spark coils. Several units in series and multiple for transformers. Substantially built of brass, electric mica and black fibre. Parts nickelled. Introductory price only \$1 per unit as illustrated. Money back if this new gap fails to please. Send \$1 bill or P. O. money order today to



K. RICHARDSON, BOX 686, ERIE, PENNA

Electrical Gifts for Xmas

- Lionel Electric Trains
- Electrical Toys
- Mesco Electric Engines
- Electric Tree Lighting Outfits

We carry a full line of Wireless Supplies, being agents of The Electro Importing Co. and J. H. Bunnell & Co.

QUAKER LIGHT SUPPLY CO.
728 Arch Street Philadelphia, Pa.

LEARNING TELEGRAPHY

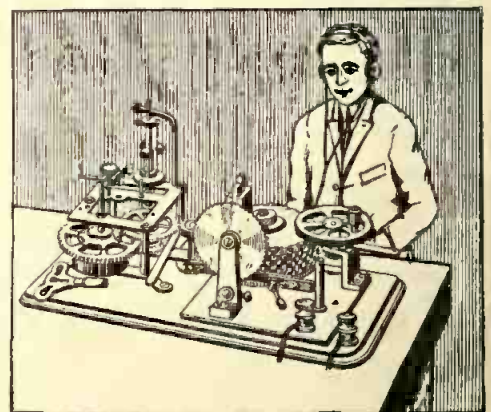

becomes simple when your instructor is the Omnigraph Automatic Transmitter. Combined with a standard key and sounder or Wireless Buzzer, it will send you telegraph messages at a slow speed, which can be increased at will to match the sending of an expert operator as you become more proficient. (Adopted by U.S. Gov't. Made in 4 styles, from \$2.50 up, all accurate. Circular free.

Omnigraph Mfg. Co., 39 L Cortlandt St., New York

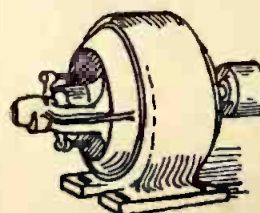

Special Dynamos for Arc Lamp in Moving Picture Shows. Special Dynamos for Charging Storage Batteries. Special Dynamos for Incandescent Lighting. We sell upon payments of \$5 and \$10 per month.

Hobart Bros. Co., Troy, O.

MAGNETIC PULL.

(391.) Verne Bonnett, Birmingham, Iowa, desires a formula for calculating the pull of a magnet at various distances from its poles.

A. The pull of a magnet varies inversely as the distance of the armature from the poles; thus, if a certain magnet will lift 20 pounds 1 inch from the pole-pieces, then 2 inches from the pole-pieces it will lift one-quarter of this amount, or 5 pounds, and if 3 inches, one-ninth of this amount or about 2.2 pounds. This law is known as the rule of inverse squares and is also applicable to lighting problems as well.

ELECTRIC WIRING QUESTIONS.

(392.) John Odill, Norway, Mich., asks several questions regarding the wiring of a house: (1) Is a person allowed to do additional wiring on his premises without permission from the authorities? (2) Where can he obtain this permission, if necessary? (3) Must the work be inspected before connecting to the service line?

A. 1 and 2. It is unnecessary to obtain permission to install additional wiring in the house and barn, but proper precautions must be taken in this work, so it will comply with the Fire Underwriters' rules.

A. 3. It is necessary that the wiring should be inspected by the Fire Underwriters' before connecting to the supply mains, or the fire insurance policy on the building will be void should it burn down from any cause.

MOTOR TROUBLES.

(393.) R. O. Shadd, Williamstown, Pa., writes regarding his 1-6 H. P. motor which sparks on the positive brush when the current is turned on, but ceases to spark when the motor reaches its maximum speed.

A. The above mentioned action may possibly be explained by the fact that the positive brush is not at the right angle of commutation and the armature, drawing more current when accelerating, will make the sparking more noticeable than when running under normal speed conditions, with the armature current somewhat lower. Another cause for this may be that one of the wires in the armature is grounded, causing an excess flow of current. When the motor reaches full speed centrifugal force might throw the wire away from the armature, thereby destroying the ground.

RADIO CONNECTIONS.

(394.) Henry E. Davies, Jr., Vineyard Haven, Mass., writes us asking for a hook-up for the Mignon cabinet style radio re-

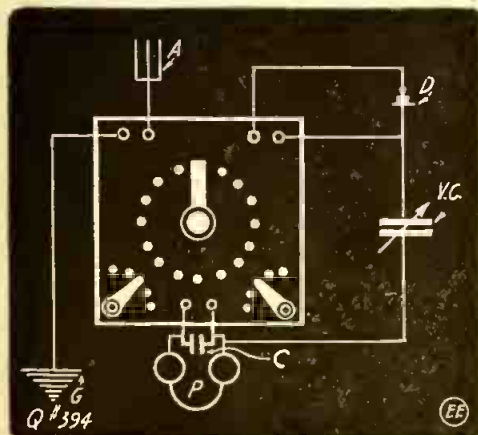

Hook-Up for Mignon Radio Cabinet Receptor. Receiving coupler, together with variable condenser.

A. We show in the diagram connections for the Mignon cabinet style radio receiving coupler, together with variable condenser, fixed condenser, detector and 'phones.

Here's the Most Sensitive Head-set for Wireless Work



On 10 Day Free Trial

Stromberg-Carlson Radio Head-Set

THIS set is guaranteed to increase the receiving efficiency of any radio station with which it is used, regardless of the type of head-set used heretofore.

This claim is based on comparative operating tests conducted at many stations. If you are skeptical, convince yourself by ordering a set for 10 days' free trial against all other makes. The price is \$8.25, and your money will be given back at once without the slightest obligation if you are not satisfied.

Dealers sell this head-set. If you cannot get it from your dealer, write us. Write today for free bulletin No. 1006.

Stromberg-Carlson Telephone Mfg. Co.
Rochester, N. Y. Chicago, Ill.

A BOUND VOLUME CONTAINING 12 ISSUES OF THE ELECTRICAL EXPERIMENTER FOR 75c.

Bound in substantial green cloth; lettered in gold. Postage on 3 lbs. is extra. A REAL BARGAIN. Book Department. EXPERIMENTER PUBLISHING COMPANY, Inc., 233 Fulton Street, New York.

Mr. King rose from Newsboy to Meter Engineer



YOU are needed NOW AS METER ENGINEER

Get the big job. Earn the big salary. Get into the new profession where high salaried positions are seeking the men. Train yourself to fill one of these big jobs. There is one or more in every Electric Light Plant. The demand is growing daily for Meter Engineers. We have trained hundreds of others and placed them in big jobs. We can do the same for you.

Earn \$1,200 to \$3,000 a Year

Just a few short months at home during spare time. You learn while you earn. Course is interesting, concise, thorough. You learn all about meters and instruments. No problem will stump you. Step into an Electric Light Plant as Meter Engineer at a salary of \$1,200 to \$3,000 a year. Our course prepares you for every emergency.

Mr. King's Rise to Meter Engineer

His experience is no different from hundreds of our students. He wanted the big job and trained for it. He has a fine position—at a big salary. His training makes him indispensable to his employer. His job is sure the year round.

FREE—Full Information—Use Coupon. Get the School Literature story of Mr. King's rise, terms, testimony from students and graduates, outline of course, duties of Meter Engineer—all absolutely free. Write to-day, "NOW." Use coupon.

Our Money-Back Guarantee
We guarantee to furnish you with our complete course of instruction in Electrical Meter Engineering and train you without charge, other than tuition as specified in our Enrollment Blank, until you are qualified to accept a position paying from \$75 to \$300 a month. Furthermore, we guarantee to assist you in securing a high grade position after you receive your Diploma. If after receiving all supplies and instructions to which you are entitled, and after fulfilling all of your agreements, you are not perfectly satisfied, we will refund the full amount of your tuition.

Ft. Wayne Correspondence School
Ft. Wayne, Ind. Dept. 352

Gentlemen:—Send me absolutely free and prepaid your new literature on Meter Engineering.

Name
Address

Fort Wayne Correspondence School
Dept. 352 Fort Wayne, Indiana

Boys-Here's Fun

ASK DAD FOR THIS TRAIN

STOP LOOK LISTEN



Write Quickly for Our New Catalog

telling how you'll have barrels of fun with a Lionel electric locomotive, Pullmans, freight cars, switches, semaphores, electric lights, track, etc. Make the trains scoot. Run 'em on batteries or a Lionel Multivolt transformer which saves batteries. (See cut below.) 250,000 boys own them—Join us. Lionel Electric Trains are safe—no shocks. They're steel—not Cast Iron—and won't

LIONEL TOYS ELECTRIC

break. Not high priced. Unconditionally guaranteed. Finished handsomely in colors and gold. If Your House Has Electricity Buy This Transformer

BOYS' BIG CATALOG FREE

Written specially for YOU, crammed full of pictures. Section of Lionel Rail Free. Most toy dealers, electrical stores and department stores sell Lionel Toys. Go to your Toy Dealer, find out if he sells Lionel Trains, tell me when you write for catalog—then I'll include a special section of rail-free.

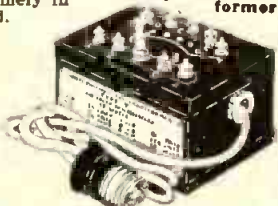

J. Lionel Cowen, A Friend of Boys, President THE LIONEL MFG. CO., 481 East 21 Street New York City

BOY ELECTRICS

Knapp Marvelectric THE GREATEST

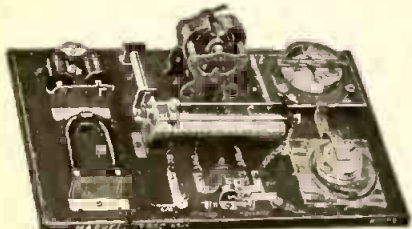

EXPERIMENTS NUMBERLESS

More fun, more information than a hundred books. Finished as shown. Demonstrates Magnetism, Solenoids, Resistance, Motors, Dynamos.

Price \$3.75

Live dealers everywhere. Order direct, or ask your dealer to show you the Knapp Line and insist on getting Knapp Goods.

Dealers not already handling the Knapp Line should ask for prices.

Catalogue illustrating many specialties on request.

KNAPP ELECTRIC & NOVELTY CO.

523 West 51st St. N. Y. CITY

THE RADIO PIONEERS.

In a recent communication to the *New York Times* Dr. Alfred N. Goldsmith, director of the radio laboratory at the College of the City of New York, said:

"I have read the highly interesting reports which have appeared in the *Times* describing the radio (wireless) telephonic experiments carried on over great distances by the American Telephone & Telegraph Co., using for the transmitting station one belonging to the United States navy (Arlington, Va.). Without desiring to disparage in the least the undoubtedly earnest and intelligent engineering work which has resulted in the accomplishment of this particular achievement, I feel strongly that less than due credit has been given to the many and eminent radio engineers who have done previous research work in this field, and without whose work the results just obtained would have been completely unattainable.

"I have been creditably informed that what are known as oscillating gas valves have been used for generating and controlling the power used in this work. While I cannot hope to gauge the relative importance of the contributions of all the previous inventors, I certainly believe that the following gentlemen are entitled to much more than a curt dismissal of their claims, and ignoring of all they have contributed to our knowledge of the oscillating gas valves. I refer to Edwin Armstrong, of Columbia University; Dr. Lee De Forest (under some of whose patents the American Telephone & Telegraph Co. is already licensed); Professor Fleming, of London University (one of the early workers in this field); Peter Cooper Hewitt, Dr. Irving Langmuir, of the General Electric Co.; Dr. Meissner, of the Telefunken Co.; Professor George Pierce, of Harvard University; H. J. Round, of the English Marconi Co.; Dr. Reisz and his associate, von Lieben, of the Telefunken Co., and Mr. Weagant, of the American Marconi Co. Three of these gentlemen, Messrs. De Forest, Armstrong and Langmuir, have in the order named made the results of their researches public in the 'Proceedings of the Institute of Radio Engineers,' and the interesting and important information which they gave has thus become available.

"It is impossible for me to apportion credit for the present achievement suitably among all the gentlemen mentioned, but it is quite certain that their united contributions to radio telephony have made the Arlington-Hawaii transmission possible. It is their due to receive credit for what they have done. It is not just that the commercial organizations involved should receive full public credit and the originating engineers be hidden by enforced anonymity. It is certainly to be hoped and expected that they will receive at least the mention which they have earned."

Electric Light for Your Home

Uni-Lectric lighting plant generates standard 110-volt direct current; operates from one to 50 lights, electric motor, electric iron, vacuum cleaner, electric toaster, force pump, churo, washing machine, etc.

No Batteries—No Switch-Board

and a better machine for less money. High speed gasoline motor, generator and automatic governor, all complete in one small, compact unit. Uses standard lamps and fixtures. Simple, easily installed, dependable, economical. Costs less than other systems to buy and to operate.

Waterman Motor Company

112 MT. ELLIOTT AVENUE DETROIT, MICH.

Write to-day for full description and low price.



PORCELAIN

"THAT'S OUR BUSINESS"

Standard and Special Shapes, Regardless of How Difficult

We illustrate one hard shape we make. A pair of rolls 7 1/2" long and 1 1/4" in diameter with 8 holes on ends and middle. They must be perfectly straight and we make them so. It's hard but not for us. We can make your difficult designs also. Send us blue print for quotations.

Union Electrical Porcelain Works TRENTON, N. J.



2 H.P. \$35 Auto Throttle Governed Engine for Every Work

There is no other four-cycle engine with automatic type of throttle governor on the market near the price. Unlike ordinary low priced engines it is not hit-once-in-a-while governed with irregular speed and wasted gasoline.

It fires every shot with exclusive auto-throttle governor which means even, economical power. It will operate electric light plant, pump water, run separator, churn or freezer, chop feed, operate machinery, in fact, it is the engine for every work.

Hopper cooled complete ready to run, 2 H. P., for only \$35. Direct to you from the factory. Write for catalogue.

C. Benninghofen & Sons Dept. 110, Hamilton, O.



This Complete, Efficient Wireless Receiving Set

RECEIVES 1500 MILES

This station is equipped with a two-slide loose coupler. The primary is wound with No. 28 bare wire, secondary wound with No. 30 silk covered wire and is divided off into 10 taps which are brought out on the end piece, contact being made by a phosphor bronze rotary switch with hard rubber knurled knob. Our new, specially designed detector will not jar out and allows a much finer adjustment than possible with any other detector. A fixed condenser of exact capacity, specially constructed for this loose coupler, affords extra efficiency. An extra pair of binding posts is provided to which a variable condenser may be connected. All parts are of solid oak and mounted on a solid oak base. The set is beautifully finished throughout and is fully guaranteed in every particular.

Send stamp for our big Wireless Catalog "E" and free code chart made of unbreakable fibre.

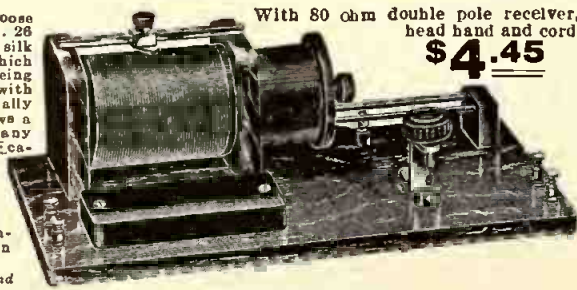

With 80 ohm double pole receiver, head band and cord.

\$4.45

Universal Wireless Co.

19 E. 32 Street N. Y. CITY

All "Universal" sets are sold with 10-day trial privilege and money-back guarantee. Prompt shipment guaranteed.

TOY TRANSFORMERS

9 Different Voltages

- 50 Watt . . . \$3.00
- 100 Watt . . . \$4.50
- 200 Watt . . . \$6.00

Wireless, Bell and other transformers

Send for Folders

DISCOUNT TO DEALERS

A. R. DARLING

1532 N. Capitol Ave. Indianapolis, Ind.



You benefit by mentioning "The Electrical Experimenter" when writing to advertisers.

PATENT ADVICE

Edited by H. GERNSBACK

In this Department we will publish such matter as is of interest to inventors and particularly to those who are in doubt as to certain Patent Phases. Questions addressed to "Patent Advice" cannot be answered by mail. Sketches and descriptions must be clear and explicit. Only one side of sheet should be written on.

FOOLPROOF ELECTRIC SWITCH.

(33.) Wilmer J. Slifer, Quakertown, Pa., submits a sketch of a novel electric switch which he terms "foolproof" for the reason that it is necessary to use a key in connection with it. He wants to know if this switch can be patented, and if such an article is in demand.

A. After looking over the drawing and the description, we have come to the conclusion that a patent could not be obtained on this device, at least, we have our doubts about it. In case a patent was actually obtained, we do not think it would be of very much value as switches of this kind are not very well liked by the trade.

ELECTRIC RAIN AND WIND SIGNAL.

(34.) Martin Hoeft, Minonk, Ill., claims to have a new device for electric rain and wind signals, but fails to submit drawings to explain the idea. In the absence of these we cannot give any advice on the merit of the invention.

INSULATOR AND AERIAL CONNECTOR.

(35.) Bernard Russell, Colorado Springs, Colo., has sent in a drawing of a new insulator on which he desires to have some advice. He also submits an aerial connector and wants to know if the latter is patentable. He inquires further if there is a market for these two articles. He furthermore wishes to know if an article can be patented by using Electrose instead of porcelain for insulation without the consent of the company.

A. The insulator presents no novel ideas and we do not think it is practical; we doubt whether a patent could be obtained on it.

The connector, however, has some very novel features, and this is an article that probably will be welcomed by many wireless people. You should by all means try to obtain a patent on this connector, and we think this can be done without much trouble.

Concerning the last inquiry, you cannot obtain a patent by simply changing one material to another. In other words, if you constructed (let us assume) a screw-driver made of aluminum, you could not obtain a patent on this screw-driver simply because it was made of aluminum. The mere substitution of materials does not entitle anyone to a patent.

TEMPORARY WIRING INSULATOR.

(36.) Walter Franseen, Woodhull, Ill., has submitted to us a new idea showing how to run temporary wiring on walls which have been papered, by using a special appliance. He wishes to know if the idea is good enough to warrant obtaining a patent on it, and whether the idea has any merit.

A. Inasmuch as no sample had been submitted to this department, we are not quite sure that the device will do everything which our correspondent claims for it. As far as we can see, the idea is novel and we think a patent might be obtained

upon it, but we would advise our correspondent to be cautious and he should try to have a search made in the Patent Office before going ahead with the patent. This is the best we can suggest in the absence of the actual model.

SELENIUM WIRELESS RELAY—ELECTRIC REGISTERING THERMOMETER.

(37.) Isaiah Rosin, Cincinnati, Ohio, submits to us a drawing of a selenium wireless relay which is supposed to work by means of a selenium cell and a telephone receiver and by its vibrating diaphragm and amplifying relaying arrangement. He wishes to know if a patent can be obtained upon this device. He also has bruited an idea on a registering thermometer which is intended to be used in registering temperatures at a distance. He wishes to know if this device is novel and whether it can be patented.

A. We find that the first idea is entirely impractical and it will not work the way it has been submitted to us. A relay does not work on alternating current and the idea of lighting a lamp as outlined in the drawing to operate a second selenium cell is not practical and will not work.

As to the electric registering thermometer, this is quite a clever idea and deserves being looked into. We think that if this device were to be worked out carefully from its present crude state a valuable patent might be obtained upon it. We would advise our correspondent to get in touch with a patent attorney.

ROTARY SPARK GAP.

(38.) William Boyle, Brooklyn, N. Y., submits a drawing of a new rotary spark gap in which two separate motors are used and the spark points being arranged in a novel manner.

A. While the idea of using two motors on a rotary spark gap is not novel, the arrangement of the spark points seems to have some merit, at least we have never seen anything quite like it.

We think the best way is to get in touch with some of the patent attorneys and have a search made in the Patent Office to find out what has been done before in this line. If you find that nothing similar exists so far, you stand a good chance of obtaining a patent.

SUBSCRIBE TO INVENTION

THE NATIONAL HELPMATE OF INVENTORS

REPORTS:—Patent Office news and decisions, and recent patents. Patent successes, market opportunities and methods.

PUBLISHED:—Valuable articles on successful inventors and their methods; the Mistakes of inventors. Helpful mechanics and manufacturing.

INVENTION

MAINTAINS a Bureau of Federal Protection, which secures strong, valid patents, and sound trade-marks and copyrights in the United States and in all countries, at a reduced cost to applicants.

BEFORE SPENDING MONEY ON PATENTS CONSULT INVENTION and the Bureau of Federal Protection.

PATENTS secured through this Bureau advertised free in INVENTION.

Send sketch, drawing, and description, or model, for report and valuable advice. Certificate of conception protects inventors, sent on request.

SPECIAL OFFER! INVENTION sent for one half year for 25c. Address

INVENTION

215 MCGILL BLDG. - WASHINGTON, D. C.

PATENTS THAT PAY

OUR TRADE-MARK

OVER \$600,000.00 MADE BY CLIENTS

PATENTABILITY REPORT

Send sketch or model of your invention for free search of the Patent Office Records and report as to Patentability.

TWO WONDERFUL BOOKS FREE!

Entitled "Inventors Guide" (146 pages) and "What and How to Invent—Proof of Fortunes in Patents" (127 pages)

Highest References, including 100 manufacturers we serve.

PROMPTNESS ASSURED

Across the Street from the U. S. Patent Office

E. E. VROOMAN & CO., 870 F Street, N.W., Washington, D.C.

REGISTERED PATENT ATTORNEYS

PATENTS AND TRADE MARKS



LANCASTER & ALLWINE

252 Ouray Bldg. Washington, D. C.
Book "Inventions—Patenting and Promoting" Free
Improvements wanted—Send for free bulletins & advice

PATENTS

THAT PROTECT AND PAY

Books and Advice Free

Send sketch or model for search. Highest References. Best Results. Promptness Assured.

WATSON E. COLEMAN, Patent Lawyer
624 F. Street, N. W. Washington, D. C.

PATENTS WANTED

Invent with valuable list of Inventions Wanted. \$1,000,000 in prizes offered for inventions. Send model or sketch for Free Opinion as to patentability. We have a Special Department devoted to Electrical Inventions and are in a position to assist and advise inventors in this field in the development of their inventions.

MODERATE FEES—WE ASSIST INVENTORS TO SELL THEIR PATENTS

Write To-Day for our Five Books sent free to any address. (See attached coupon:)

FREE COUPON!

VICTOR J. EVANS & CO., Patent Attorneys

NEW YORK OFFICES: 189-191 Broadway

PHILADELPHIA OFFICES: 1429 Chestnut St.

Main Offices: 779 9th Street, N. W., WASHINGTON, D. C.

GENTLEMEN: Please send me FREE OF CHARGE your FIVE Books as per offer.

NAME ADDRESS



MILLERS FALLS TOOLS

For the Home, Shop or Laboratory

THE experimenter is usually a particular man who is particular about his tools.

Experimental work calls for accurate tools and not the least of these should be a good reliable bit brace.

The next time you visit a hardware store for any purpose just remember to ask to see

MILLERS FALLS Bit Brace No. 732

Ball bearing head. Protected Ratchet. Free acting sweep handle, chuck jaws permit accurate centering and hold bit with a bull dog grip. Nickered steel parts and fine polished wood handles. Send for handy pocket catalogue of complete line.

MILLERS FALLS CO.

"Toolmaker to Master Mechanics" Millers Falls, Mass.

BUILD AN AEROPLANE



We'll Show You How "Ideal" Nieuport Monoplane. Complete outfit, all parts, ready to assemble. \$5.

Thousands of American Boys, and grown-ups, too, are building and racing aeroplanes. It's the great new American Sport.

By means of our simple, easily understood plans and instructions we'll show you how to build an

EXACT 3 ft. WAR MODEL Guaranteed to Fly

Not a toy, but a wonderfully interesting real miniature flying machine with which you can have intensely fascinating and instructive sport.

We make war models of all the well-known types of aeroplanes. An especially popular knock-down model is the

"IDEAL" 3ft. TAUBE MONOPLANE

Duplicating exactly the famous German aeroplanes used in the EUROPEAN WAR. Complete with plans, simple directions and all parts, including rubber-tired disc wheels, ball-bearing propeller shaft, hand carved wooden propeller, etc. Guaranteed to rise from the ground by its own power and fly. Delivered, ready to assemble, all charges paid. **\$4.25**

Scale Drawings with building and flying instructions sold separately at following prices:
Curtiss Flying Boat... 25c Bleriot Monoplane... 15c
Curtiss Military Tractor 25c Taube Monoplane... 25c
Hydroaeroplane... 35c Wright BiPlane... 25c
Nieuport Monoplane... 25c Cooil Peoli Raocer... 25c

BUILD A FLEET. Race one type against the other. Get a complete set of above 8 Plans for \$1.60.

There's a dealer near you who sells parts and plans for "Ideal" Aeroplanes. If you can't find him, write us.

Write to-day for our 50-page Aeroplane Book containing full information, prices for parts, complete models, etc., postpaid 5c.

IDEAL AEROPLANE & SUPPLY CO.
76-82 West Broadway New York City

ELECTRICAL WAY TO FATTEN SHEEP.

Electric lighting of pens at night causes sheep to eat frequently and accordingly grow fat for the markets in record time. The tour made through the ranch section of Oregon by Samuel Galland, a Spokane financier, resulted in the discovery that the Oregon sheep growers are using electricity extensively for both light and power.

Besides being applied for pumping in irrigation districts and for doing nearly all the ranch work, electricity has been wired into the sheep pens. The light is turned on at 4 o'clock in the afternoon in winter and burns until 9 o'clock. The ranchers find that sheep will eat during off periods when the light is turned on. At 4 o'clock in the morning lights are switched on again and the sheep again begin to feed. Frequent feedings encourage the animals to eat so much that they are quickly fattened for the market.

BARON MÜNCHHAUSEN'S NEW SCIENTIFIC ADVENTURES.

(Continued from page 388.)

have been in Flitternix's mind too, for presently he set his chronometer to noon, which, of course, was a ridiculous thing to do, for we did not know if the Martians divided their day into 24 hours or into 100 hours.

"We were now floating some 1,500 feet up over what we afterward knew to be the Martian National Capital, the 'city' of the Ruler. It is located in the elliptical spot which terrestrial astronomers have marked as 'Solis Lacus' on their Martian maps."

"As if our host had divined our innermost wishes, we soon passed over the capital and approached the waterway which you will find in your Martian map under the name of 'Nectar'."

"The Martian Canals! At last we beheld one of them at a distance of less than 2,000 feet! The riddle of terrestrial astronomers for over a century! The cause of one of the most heated controversies on Earth! And now we saw them close by with our own eyes!

"The 'Canal' proper, which is termed 'Nectar' by astronomers on Earth, is about 6 miles wide. It runs in a perfectly straight line for over 500 miles and is about 20 feet deep. Like all other Martian waterways, it is lined with the Universal Martian material termed TOS, which looks like glass, yet is not glass. The Tos in this instance is waterproof, is an electrical conductor on one side and an insulator on the other. Yet it is a solid body and much harder and tougher than steel. The conducting side is turned toward the water, and when a certain current of ION is sent through the Tos, the water near it loses all weight because the gravitational attraction of Mars is neutralized thereby. It becomes now an easy matter to move the tremendous masses of water, a problem which your earthly scientists could never solve.

"At each bank of the vast waterway we saw immense towers about 2,000 feet high. These towers are spaced about 5 miles apart and follow the entire course of every canal. Their purpose is as follows:

"At the top of each tower is an immense 'pyramid,' made of a certain variety of Tos. The sides of these pyramids are formed of thousands of small black cells, which, when exposed to the Sun's rays,

* See accompanying map of Mars. Solis Lacus is located at about 30° latitude and 90° longitude. Nectar runs from the eastern (left) edge of Solis Lacus, due east.

WIN HEALTH

NEWEST FORM OF ELECTRICITY FOR YOUR OWN PERSONAL USE



The VIOLETTA HIGH-FREQUENCY GENERATOR is used and endorsed by thousands of physicians. It generates the Violet-Ray High-Frequency Current which is used with wonderfully quick results for facial, scalp, and body treatments.

Compact, efficient, operates on alternating or direct current, and absolutely safe and guaranteed. A scientific marvel in construction.

Write now for our limited special 10 day FREE TRIAL offer.

AGENTS RESPOND

Bleadon-Dunn Co., 208 N. 5th Ave., Chicago, Ill.

BUILD YOUR OWN Grandfather's Clock WITH OUR HELP



We furnish blue prints, finishing material and instructions. Buy the works, dial, weights and pendulum from us at surprisingly low prices. You make a fine profit building artistic clocks for your friends. Complete works, \$5.00. Others with chimes at all prices.

Ask for attractive free offer.

Clock Company
1661 Ruffner St. PHILADELPHIA, PA.

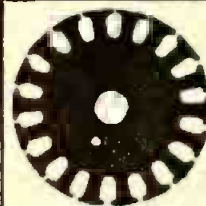

Armature Discs

AT FACTORY PRICES

Any size from 2 1/2 inches to 14 inches in diameter. Best grade material with jappanned insulation on one side. Send stamp for circular.

FRED. R. HEILMAN
444 Niagara St. Buffalo, N. Y.

Experimental and Model Work ELECTRICAL INSTRUMENTS AND FINE MACHINERY

Inventions developed. Special Tools, Dies, Gear Cutting, Etc.

HENRY ZUHR

32-34 Frankfort Street New York City

EXPERIMENTERS—INVENTORS



Let us develop your inventions and make your working models.

Our well equipped shop and staff of experienced model builders are at your service.

We carry a complete stock of gears. Shipment made same day order received.

Send 4c in stamps for booklet 'Inventors' Supplies.

UNION MODEL WORKS, Established 1882
119 S. Clark St., Chicago

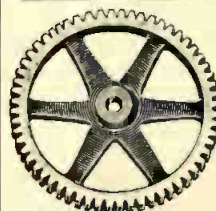

BRASS GEARS cut by an entirely new process. The most accurate made and at prices that cannot be equalled by others. Every gear has a hub, center painted ebony black, edges turned true, highest grade red brass, and much heavier than others. We carry the largest stock in the world, and every gear listed is always shipped on date of order. SEND FOR CATALOGUE

CHICAGO STOCK GEAR WORKS
20a So. Fifth Ave. :: Chicago

Experimental Work at Reasonable Prices TOOLS AND DIES

Light Machinery Designed and Built. Automatic Machines. Cams Cut Exactly to Template

GEO. SCHWARZ & CO.

123 Liberty Street NEW YORK
Send sketch or blue print for estimate

READ the Classified Advertisements in this issue. They are small but contain big bargains and opportunities.

absorb the heat of the latter. As the surface of these pyramids is very large, a proportionally large amount of heat is received. This heat is directly transformed into ION and stored within the pyramid. The latter turns on its axis, so as to present the largest possible surface to the Sun from sunrise until sunset; also as more power is generated than needed during the daytime the excess is used during the night.

"Now, then, from the top of the pyramid a gigantic Emanation Ray bursts forth, fed from the stored ION, originally secured from the Sun's heat.

"This ray is made to fall over the entire width of the waterway, and it is directed on the latter at an angle. The ray striking the water, which does not resist, as it has no weight, as explained to you, must naturally move away from the direction of the ray. This it does, the Emanation Ray 'pushing' the water at a rate of about 2 1/4 miles an hour. If it was not for the ray the water would, of course, be entirely motionless, for the Martian waterways are exactly level, there being no 'fall' to them.

"As each tower assists in moving the water over a certain distance the water gradually acquires momentum and flows slowly but steadily. Before the momentum has been expended, the next tower is reached, which pushes the water on to the next one, and so on through the entire length of the Canal. You will naturally understand that these towers must work nights as well as during the day, else the water would not flow during the night. The stored surplus power during the day, of course, makes this possible. Furthermore, the towers work to their full efficiency and uninterruptedly year in and year out, for there are no clouds to hide the Sun on Mars, as it is well known; consequently, the pyramids are never without power, except nights.

"You realize that all the towers must throw their rays in the same direction, which, of course, they do; thus, if the water is to be moved in one season from North to South, the rays face the South. During the next season when the flow of the water must needs be reversed, as explained to you yesterday, the Emanation Rays will all point northward. Thus one of the great problems on Mars has been solved. But who does the work? The all dominating Sun.

"And who moves the waters on Earth? Who, condenses the waters from the oceans and lifts up myriads of tons of water year in and year out, to form clouds, which latter produce the rains, without which your rivers would run dry within four weeks? The

WANTED

Railway Mail Clerks
\$900 to \$1800 a Year
(\$75 to \$150 a month)

Rapid advancement to higher Government Positions. "No layoffs" because of STRIKES, WARS, FINANCIAL FLURRIES or the WHIMS OF SOME PETTY BOSS. THE POSITION IS YOURS FOR LIFE.
Country residents and city residents stand the same chance for immediate appointment. Common-sense education sufficient. Political influence NOT REQUIRED.
Write immediately for schedule showing the places and dates of THE COMING GOV'T examinations. Don't delay. Every day you lose means the loss of just so much coaching before the rapidly approaching examinations.
FRANKLIN INSTITUTE, Dept. D 113, Rochester, N. Y.



Pleasant Work—Continually Traveling

Franklin Institute (The Pathway to Plenty), Dept. D 113, Rochester, N. Y.
This coupon, filled out as directed, entitles the holder to free specimen questions; a free copy of our book, "Government Positions and How to Get Them," a list of Government positions now obtainable, and to consideration for Free Coaching for the examination here checked.

- | | |
|--|--|
| ...Railway Mail Clerk. \$900 to \$1800 | ...Customs Positions. \$800 to \$1500 |
| ...Bookkeeper. 900 to 1800 | ...Stenographer. 800 to 1500 |
| ...Postoffice Clerk. 800 to 1200 | ...Internal Revenue. 700 to 1800 |
| ...Postoffice Carrier. 800 to 1200 | ...Clerk in the Departments at Washington. 800 to 1500 |
| ...Rural Mail Carrier. 500 to 1200 | ...Canadian Gov't Positions. |
| ...Auto Chauffeur. | |

Name..... Address..... D113
Use this before you lose it. Write plainly.

Do It Electrically



The applications of electricity are increasing every day. The man who has an exact knowledge of electrical science has ever growing opportunity for profit. Ten years ago practically all machines in use were run by steam engine and countershaft. Statistics now show that most of the machines used are now operated by the electric drive. A generation ago gas was the only known means for lighting and cooking. Now almost every modern house is lighted by electricity, and electric cooking utensils are coming more and more in use. Even the steam locomotive, that great achievement of the twentieth century, is being gradually replaced by electric power. Whether it be for driving machines, for railway transportation, for lighting, for heating, for cooking, for a thousand daily necessities, the watchword of the age is "Do It Electrically."

Hawkins Electrical Guides Will Show You How

Electrical knowledge means money to you and these books will show you how to get it. Hawkins Electrical Guides are the standard works on Electricity. They cover every single phase of the subject and they are written in a way you can understand. The text matter is arranged in questions and answers, and contains several thousand illustrations. No more groping for a solution of your electrical problem. You find the answer at once, clearly and concisely.

A Most Complete Library of Electricity at the Lowest Cost

Look at the titles and convince yourself that Hawkins Electrical Guides tell you everything you want to know in Electricity. They are a complete course in Electrical engineering, written especially for the ambitious man who is training himself for advancement, for the wide awake man who is likely to be called in for work outside of his regular line, for the man who needs at his elbow, for ready reference, an accurate up-to-date work on electricity. An examination of these books will convince you of their value instantly. They cost \$1 per volume. They are a wonderful buy at this price, and they are the best electrical books at any price. Don't take our word for their merits. Fill out the coupon today and the books will be sent you absolutely FREE for your own examination. You have seven days full use before you pay a cent.

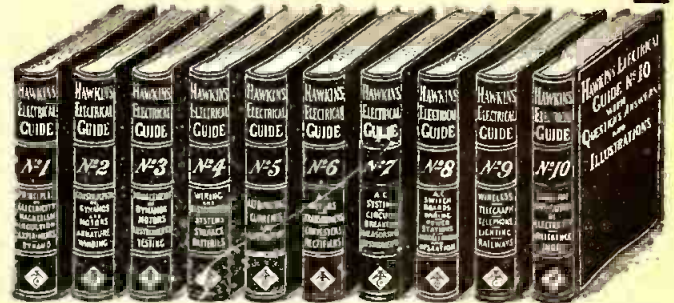

In Handy Separate Volumes The binding is in flexible black leather with gold edges—very durable and attractive. The books are easy to handle and easy to read. They fit your pocket and your pocket-book as well.

Shipped to You FREE

Send no money. Examine the books first. Decide for yourself that they are the most complete library of electricity ever published, and that you cannot afford to be without them. Every book is complete in itself. The price is only \$1 per copy, but the complete set is the best bargain. Settlement can be made at only \$1 per month. EIGHT NUMBERS ARE READY.

FREE COUPON

Theo. Audel & Co.
72 Fifth Avenue
NEW YORK

Please submit me for examination Hawkins Electrical Guides (Price \$1 each). Ship at once, prepaid, the first eight numbers; if satisfactory I agree to send you \$1.00 each month until paid.

A FEW OF THE SUBJECTS
Magnetism—Induction—Experiments—Dynamo—Electric Machinery—Motors—Armatures—Armature Windings—Installing of Dynamos—Electrical Instrument Testing—Practical Management of Dynamos and Motors—Distribution Systems—Wiring—Wiring Diagrams—Sign Flashers—Storage Batteries—Principles of Alternating Currents and Alternators—Alternating Current Motors—Transformers—Converters—Rectifiers—Alternating Current Systems—Circuit Breakers—Measuring Instruments—Switch Boards—Wiring—Power Stations—Installing—Telephone—Telegraph—Wireless—Bells—Lighting—Railways. Also many Modern Practical Applications of Electricity and Ready Reference Index of the 10 numbers.

Easy Payments

Accept this great offer now—today. Each page—every illustration will convince you of the big value we are offering. See the books first, then decide. If you decide to keep them you can make settlement at only \$1 monthly until paid for.

Mail Coupon Today

Signature.....
Occupation.....
Business Address.....
Residence.....
Reference.....

THEO. AUDEL & CO. 72 Fifth Avenue
NEW YORK, N. Y.

Learn Electricity!



"I'll Pay You \$175 to \$300 Per Month!"

That's what many superintendents and managers have said to OUR GRADUATES. That's what one will say to YOU. It's not out of the ordinary. In fact it is just what can happen if you become a COYNE trained man. It means success for you for life. Any man between the ages of 15 and 50 who has ambition, no matter how little education, can learn this big paying trade in our schools in a short time and at small expense.

COYNE NATIONAL TRADE SCHOOLS

Largest and best equipped trade school in America. For 15 years we have sent hundreds of men out annually as skilled mechanics to help supply the rapidly increasing demand. Let us train you for one of these big jobs. Our employment bureau places graduates into big paying positions free of charge.

Men Wanted For These Trades



Electricity
Plumbing
Bricklaying
Motion Pic. Opr.
Mech. Drafting

Our Own Building

We teach all these big paying trades under actual working conditions. We do not have classes, do not use books, do not teach by correspondence. Each man is instructed individually right in our big shops. Drafting, Estimating and Plan Reading included in ALL courses.

We charge a small tuition fee which can be made in easy payments if desired. All tools, equipment and material is furnished by the school FREE. Our institution is open Day and Evening. Many of our students earn a part or all of their expenses while attending. Our employment bureau is always ready to assist a man to earn expenses, without charge.

SEND COUPON FOR FREE BOOK

FREE COUPON

B. W. COOKE, Manager
COYNE NATIONAL
TRADE SCHOOLS
Dept. 1598
39-51 E. Illinois St.,
CHICAGO, ILL.

Without any obligations on me whatsoever, please send me your book of trades and full particulars—ALL FREE.

Be a man of action. Send today for our book of trades—fully illustrated. It costs you nothing and shows how you can earn more money, make a bigger success than you ever dreamed of. If you live near, come over and go through our shops—visitors are always welcome.

B. W. COOKE, Manager
COYNE NATIONAL
TRADE SCHOOLS
Dept. 1598
39-51 E. Illinois St.,
CHICAGO, ILL.

Name.....

Address.....

LEARN the AUTO BUSINESS

Earn a Splendid Salary or Have a Business of Your Own



The Auto business is growing by leaps and bounds; there are better opportunities now than ever before, for properly trained men as Chauffeurs, Demonstrators, Mechanical Experts, etc. Over 3,000 of our graduates are making good money. Most Up-to-Date—12 Years of Success.

Latest equipment including 8 and 12 cyl. cars; latest types motors and lighting and starting systems.

Individual Instruction. Tuition and Board reasonable. Write at once.
CLEVELAND AUTOMOBILE SCHOOL
2343 Euclid Ave. CLEVELAND, O.

Sun, of course!

"Only on Earth the Sun does it in a natural manner; here on Mars, the Sun works just the same, but without the intermediary of the clouds."

* * * * *

There was the familiar snapping sound in my receivers, a low click and everything was quiet. I knew that the telegraph wire on the Moon must have been filled to capacity, and that I would not hear again from Münchhausen till the next evening.

(To be continued.)

SUBMARINE F-BOATS ALL UNSAFE, NAVAL BOARD FINDS

The preliminary investigation into the cause of the sinking of the submarine F-4 on March 25 last at the entrance of Honolulu Harbor has resulted in a report to the Navy Department, which asserts that all four of the submarines of the F class, including the F-4, had inherent faults, and were difficult to keep in repair and that serious trouble was experienced with their propelling engines, electric motors and storage batteries; in short, that they were in a dangerous condition for use on long dives like the one on which the F-4 met with the accident which wiped out the lives of her officers and crew.

The Board of Inquiry found that the storage batteries of the F-4 were always in a state of being more or less electrically "grounded," due to leakage of electrolyte, and that these "grounds" have been of sufficient intensity to cause flame and the fusing of electrical connections, also that these faults obtained in all four of the boats of the F class, of which there are three remaining, the F-1, F-2 and F-3. The F-4's storage batteries evolved excessive quantities of hydrogen gas. The fumes of hydrogen and acid were noticeable inside the F-4 on long dives and on March 6 last, some days before the F-4 was lost, there was a hydrogen explosion in that submarine which damaged the battery deck and broke several separators of the cells. The report just received by the Navy Department asserts that the "conditions under which an explosion of hydrogen is always possible obtain in all the boats of the F class."

RADIO LINKS TWO PRESIDENTS.

It was announced at the Navy Department recently that congratulatory messages were exchanged between the President of the United States and the President of Guatemala in celebration of the opening of a new high-power radio station erected in Guatemala City, Guatemala.

The naval station at Arlington, Va., handled the American messages.

NEW ELECTRIC AIR WARMERS.

The approach of cool weather is directing attention to the subject of convenient electrical means for warming rooms. To the variety of these equipments now available there has been added recently a new line of electric portable and fireplace heaters, which is made by a Western manufacturer.

A complete assortment of these is on display in the Manufacturers' Building at the Panama-Pacific International Exposition.

These heaters are all of unique construction, with one or more heating units. The one shown in Fig. 1 resembles an enlarged desk telephone stand, and has one heating unit consuming 615 watts. It is made of brass, highly nickeled. The height of the outfit is 16 inches, and the base is 6.5 inches in diameter. The weight is about five



THE N. Y. ELECTRICAL SCHOOL is the pioneer and premier school of the "Learn by Doing" method. When you have completed this Course you shall be fully qualified to handle ALL branches of Electrical Industry. The equipment of this School is unequalled and up-to-the-minute. No preparation needed to become a "learner" in this school. You can start to learn on any day of any week throughout the whole year. Send for catalogue.

New York Electrical School

29 West 17th Street New York City

LET SAM BROWN TEACH YOU THE AUTOMOBILE BUSINESS

He'll fit you for a good job as chauffeur, tester, repair man, salesman, etc., in 3 to 5 weeks. Sam teaches you personally—is right on the job every minute. Established six years.

Earn \$75 to \$300 a Month

Good jobs everywhere are waiting for good men. Complete equipment to work on; 4, 6 and 8 cylinder cars for students' work. No theory. Sam is practical. Short on lectures—long on actual, practical work. When you finish you are ready to tackle any auto problem. You're as good as the best. Sam does a good job. Learn from a practical mechanic. I have a fine 3 story building, at 1513-21 Prospect Ave., and 1820-26 Brownwell Court. Welding and Bronzing Depts.; large, well equipped machine shop; Radiator, Fender and Tire Depts. Start in at once. Drop in and see me, or write—Sam Brown.

Ohio Auto School

Dept. 212, 1521 Prospect Ave. CLEVELAND, O.

Learn to PAINT SIGNS and SHOW CARDS

I'll teach you personally by mail. 16 years' successful teaching. Big field for men and women. You can EARN \$18 TO \$45 A WEEK. Weaver (Canada) says "Your course increased my salary 50 per cent." Write for full particulars. See what's in it for you.

DETROIT SCHOOL OF LETTERING
Chas. J. Strong, Founder Dept. 3712, Detroit, Mich.

WE TEACH WIRELESS BY MAIL

You May Learn Theory, Code and Laws of Radio Communication in Our School or at Your Home.

fitting you for positions paying good salaries with wonderful chance to travel the world over. It's the most interesting profession known and the demand for skilled operators is increasing. Send stamp for catalog which gives full information.

NATIONAL RADIO SCHOOL, 1405 U St. Washington, D. C.

We Guarantee First Grade Commercial Operators' Licenses



We Solely Teach and Specialize on Radio Telegraphy

LEARN WIRELESS

SEE THE WORLD AND GET PAID FOR DOING IT

Last year every one of our graduates successfully passed his required commercial Government Examination upon the first trial. These results speak for themselves. Send a stamp for new fall prospectus. Fall classes now forming.

Eastern Radio Institute
899 B. Boylston St., Boston, Mass.

START NOW LEARN TELEGRAPHY and WIRELESS

Students who start now reap the advantages of the wonderful opportunities created by the war and which will multiply when peace is declared. Our book on "Telegraphy and Wireless as an Occupation" sent on receipt of 10c. It gives much necessary and valuable information.

BOSTON SCHOOL OF TELEGRAPHY
18 Boylston St., Boston, Mass.

WILL TEACH YOU ENGINEERING TECHNICAL WORK MACHINE DESIGN



This is the best course ever publicly offered. It includes work and drawings made by me for the past 27 years for U. S. and Foreign Governments. It constitutes a complete study of all branches of machine design, mechanical drawing and real shop system. None of the usual Correspondence School out and dried material. It starts at the beginning, takes you through the simple Geometrical Problems and gradually advances until you have a thorough training in Machine Design and a fair knowledge of U. S. and Foreign patent laws.

MAIL A POSTAL FOR FREE LESSON. Pay as you learn. Terms arranged to suit yourself. CONSULTING ENGINEER, Room 10 Meigs Bldg. Bridgeport, Ct.

Meet Your Personal Needs

If you want to specialize in some form of electrical education suited to your needs, for a longer or shorter time, there is one place giving you boundless opportunity. High school not required for this work. Also, usual courses to degrees. Open nearly all the year. Start almost any time. Expert faculty. Cost low now. Write for information to

HIGHLAND PARK COLLEGE
President, George P. Magill, A. M., D. D.
Des Moines, Iowa



Learn Wireless Telegraphy. There is an ever increasing demand for competent operators—this profession offers steady employment at a good salary—wireless operators travel all over the world. **THE PAINE UPTOWN BUSINESS SCHOOL**
1931 Broadway, (65th) New York. Send for Catalogue

TELEGRAPHY AND TRAIN OPERATION

Taught by retired railway officer. Railway wires in advanced rooms. Expenses earned. All graduates placed direct in the telegraph service. Send for Folders and Rates **Pelmar School of Telegraphy, Madison, Wis.**
America's Scientific Railway Training School

pounds, making this a very handy device that can be readily placed where desired. The reflector behind the heating unit directs the heat to the point where it is needed.

The heater, or rather stove, shown at Fig. 2, will take the place of a small coal or oil stove, and it stands 28 inches in height. It weighs 13 pounds and has two heating units which consume 960 watts.

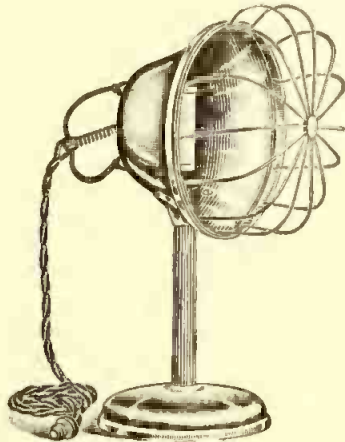

Fig. 1. Small Size Electric Heater of New Type.

Body and guard are finished in white or black enamel, the balance of the heater being highly nickeled.

This form of heater will give a great deal more satisfaction to the user than any electric heater yet placed on the market, say the builders. High efficiency is obtained by operating the heating units at a high temperature, thus increasing the resistance and decreasing the operating cost. They can produce heat comparing with other radiators at approximately 20 per cent. lower amperage.

They do not depend solely on the wire temperature for radiation, and the high temperature surrounding the unit is not affected by outside atmospheric conditions as readily as the comparative low temperature produced by other heaters; in other words, it is a more permanent heat.

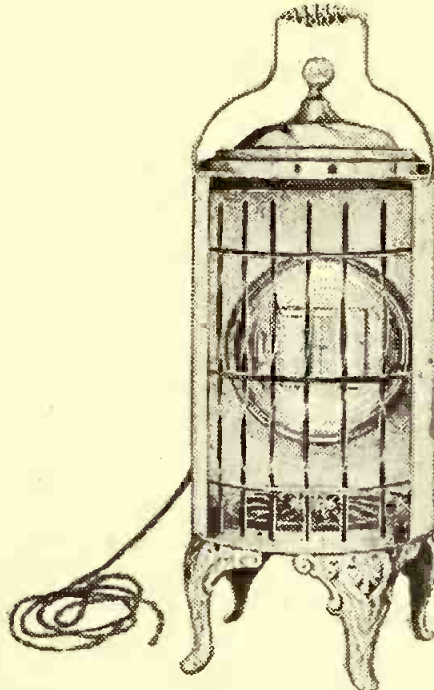
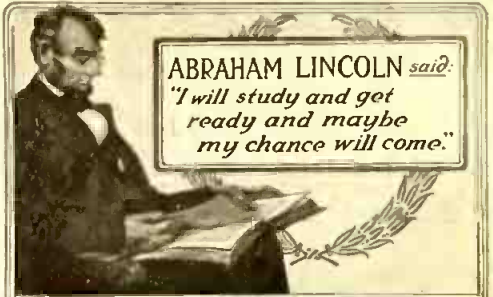

Fig. 2. Electric Stove of Neat Pattern. Consumes 960 Watts.

Superior durability for the heating unit is claimed and from the thermal point of view in regard to durability, the individual parts of the units are being operated on an average of 30 per cent. below fusing point, and this allows for any condition arising which may cause trouble in case of an excessive voltage.



ABRAHAM LINCOLN said:
"I will study and get ready and maybe my chance will come."

YOUR Chance Will Come

Born in a log cabin, Abraham Lincoln had little chance to acquire an education. But he was determined to succeed. "Some day," he said, "my chance will come." So he studied and got ready. And his chance DID come.

Your chance will come. Some day you'll be considered for promotion or for a good job in some other line of work. If you are ready, you'll go up.

And you CAN get ready. No matter if your schooling was limited—if you do have to work long hours. If you really want a better job, the International Correspondence Schools can train you for it at home during your spare time.

More than Five Thousand I.C.S. Students every year take the trouble to report promotions or salary increases due to I.C.S. help. What the I.C.S. have done for these men they can do for YOU.

Mark the Coupon NOW

Just mark the position or occupation you prefer and mail the coupon today. Finding out costs nothing.

International Correspondence Schools
Box 1071-T, Scranton, Pa.

Please explain, without obligating me, how I can qualify for the position, trade or profession before which I have marked X.

ELECTRICAL ENG. Electric Lighting Electrician Interior Wiring Electric Car Running Telephone Engineer Telegraph Engineer STEAM ENGINEER Mining Engineer Chemist BOOKKEEPER Higher Accounting Shorthand & Typewriting Good Eng. for Ev'ryone CIVIL SERVICE Railway Mail Clerk SALESMANSHIP ADVERTISING	MECHANICAL ENG. Mechanical Draftsman Shop Practice Gas Engineer ARCHITECT Builder & Contractor Structural Draftsman Plumbing and Heating CIVIL ENGINEER Surveyor Railroad Construction CONCRETE ENG. Textile Manufacturing ILLUSTRATOR Window Trimmer Show-Card Writer Agriculture AUTO. RUNNING
--	---

Name _____
Street and No. _____
City _____ State _____
Occupation _____
Employed by _____

You benefit by mentioning "The Electrical Experimenter" when writing to advertisers.

Square Deal Miller Says—



1916 Models Now Ready!

Any Watch You Want On Credit



**Waltham
Hamilton
Howard
Elgin
Illinois-Rockford**

All 1916 Models.

I am the first man in the country to offer **NO MONEY DOWN** \$2.75 a month for the **New 1916 Models of America's** best known watches. I have them all, the latest products of the world's most famous factories. You can get too, the latest mountings for **Diamonds** and the most up-to-date **Jewelry**, at the right prices.

No Money Down

Express Prepaid in Advance by Me

You take no chances with me. I am "Square Deal" Miller and I trust the people. That is why I am doing the greatest credit Watch, Diamond and Jewelry business in the country. Suppose you want a watch, a **New 1916 Model**, a brand new up to date one. Name any one. I have it for you. **No money down, Express prepaid.** A full month to carry it in your pocket; and the easiest of Long Time Payments. That's the test that tells. All these **Watches Guaranteed for 25 Years.**

I Smash the Terms

NO REFERENCES DEMANDED

My terms will surely suit you. You get unlimited credit, with no red tape, notes or collectors.

An "Open Charge" Account

the same kind of credit you get from your grocer. No matter where you live or what your income might be, you can now own the finest of watches, a beautiful diamond or any rare jewelry and never miss the money.

1916 Catalog FREE Send me your name and address so I can mail you Free and postpaid, the most beautiful catalog of its kind ever printed. I want you to have this book. It's a gem. It illustrates all makes of valuable **Watches, Elegant Genuine Diamonds** and a vast assortment of **Beautiful Jewelry**, all on the easiest and most liberal terms. Write for book today and get a letter from me that will make you my friend from the start.

Square Deal MILLER, Pres.

Miller-Hoefler Co., 545 Miller Bldg., Detroit, Mich.

THE BOYS' OWN LABORATORY CHEMCRAFT

A Complete Outfit of **CHEMICALS** - (39 Chemical Reagents) **APPARATUS** - (All Necessary Apparatus) **INSTRUCTIONS** (The Chemcraft Book)

for performing over 50 Different Experiments. Each experiment can be repeated many times.

Under the heading "Chemistry and Its Application to the Industries" are many experiments in which the products of our great chemical industries are really manufactured on a small scale. Everything is explained in a clear interesting way.

Chemcraft also contains 30 mysterious experiments in Chemical Magic. It's great fun to show these to your friends.

If your dealer does not have Chemcraft we will send yours direct. Price \$1.50 postpaid. Descriptive literature sent on request.

THE PORTER CHEMICAL CO., Hagerstown, Md.

EXPERIMENTERS

We have what you want. **SamarSKite**, radio-active mineral, based upon **Uranium**. 100 lbs. contain 1.75 milligrams **Radium**. Price per pound \$4.20; large discounts on orders of 5 pounds and over. 1 oz. sample sent for 60 cts. cash.

Le-Bar Chem. Co., Manufacturers Balto., Md.

TO BREAK FOGS BY ELECTRICAL WAVES.

Shipping men in New York are interested in an announcement from San Francisco that experiments are to be made there in an effort to dispel fog by the use of electrical waves. The problem of clearing such inland waters as New York Harbor from the dense mists that often interfere with navigation has engaged the attention of experts for many years, but no scheme within reasonable cost has yet been brought forward.

Recently oil has been suggested. The Hydrographic Office of the navy is tentatively considering this subject.

The news from San Francisco is to the effect that Government scientists have constructed a giant electrical machine with which experiments are to be carried on in the harbor. The machine is a giant electrical transformer, the largest one ever built. It can take a current of 1,000 kilowatts at 2,300 volts and "step" it up to 1,000,000 volts. This charge is expected to produce a broad, continuous flash of lightning 100 feet long. Experts believe the result of this electrical disturbance will be to clear up a fog or mist for some distance; that is, in comparatively inclosed waters. The experiments will be watched with great interest by steamship men and navy officers.

Peter Cooper Hewitt, a recognized expert in matters electrical, in expressing his views as to the efficacy of this method, said: "I have not gone into the question, so I am unable to properly discuss it, but I see nothing improbable in its efficiency. It might work in small inclosed spaces and under proper conditions. As I recollect, somewhat similar experiments were conducted several years ago on the Thames at London to clear the deck spaces of the fogs. The results were said to be of a satisfactory character, but what has been done since then, if there has been any continuance of the work, I am not informed."

BOOK REVIEWS.

ALTERNATING-CURRENT ELECTRICITY AND ITS APPLICATION TO INDUSTRY. (First Course.) By W. H. Timbie and H. H. Higbee. Cloth covers; 534 pages; 5 1/4 x 8 inches; 370 illustrations. Price, \$2.00. Published by John Wiley & Sons, N. Y. City.

This book is planned to meet the requirements for a work, simple enough to be readily understood by the beginners, yet sufficiently advanced to form a basis for engineering calculations and practical A. C. work.

Power transmission, fundamental ideas of A. C. currents, different arrangements of circuits, power factors, reactance and construction of single and polyphase generators, are among the subjects covered.

The text is well illustrated with many clear analogies and photos of actual apparatus. The subject is covered in a rather broad manner to give the reader a clear grasp on alternating current theory and practise, while the authors promise another course, soon to be ready, which will cover the subject more in detail, as to the characteristics and operation of commercial types of machines and appliances.

APPLIED ELECTRO-CHEMISTRY AND WELDING. By Charles F. Burgess, E.E., and George W. Cravens. Cloth covers; 140 pages; 135 illustrations; 5 1/4 x 8 1/2 inches. Published by American Technical Society, Chicago, 1915. Price, \$1.50.

A practical treatise, written in a clear, readable style, that is sure to increase the interest in practical applications of electrolysis and welding.

The first part covers the subject of electrolysis, electro-plating, decomposition, high tension generation of ozone and the method of nitrogen fixation in an impressive and non-technical manner.

The remainder treats of electric welding in all its forms. The various application of electrical, gas and chemical welding, are discussed at length. This book is worthy of perusal by every worker in the above-mentioned field, who will find his time well repaid by such reading.

ELECTRICAL INSTRUMENTS. By W. H. F.

SELF-SHARPENER FOR SAFETY RAZORS

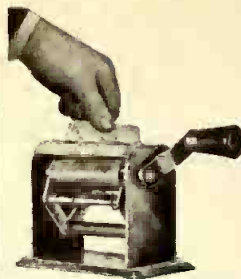

Insert safety blade (any but Durham Duplex), turn handle few times. Hones and sharpens one operation; keen cutting edge like new. Sent anywhere for \$3. Money back guarantee. AGENTS WANTED.

CIRCULAR EE ON REQUEST.

IN.MFG. CO., 1 W. Broadway, New York



Hair Grows

When properly nourished. Our **VACUUM CAP** draws the blood to the hair roots. The blood is nature's nourishment and when properly supplied, it promotes hair growth, stops falling hair, and dandruff disappears. Our cap is used by Physicians, and men who know it to be the Scientific method of promoting "Hair Growth." We send our Vacuum Cap on 60 days' free trial. Write for our booklet on "Hair and its Growth" testimonials, and application blanks, sent sealed in a plain envelope free.

The Modern Vacuum Cap Co.
470 Barclay, Denver, Colo.

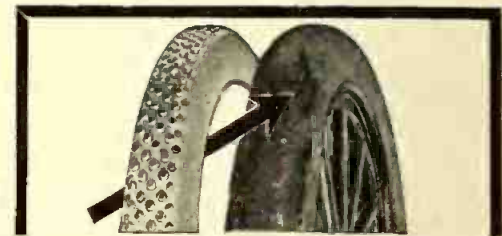

Don't Throw Away Your Worn Tires

You can get 5,000 miles MORE service from them

For over three years European Motorists have been getting from 10,000 to 15,000 miles out of their tires by "half-soling" them with Steel Studded Treads, just as we half-sole our shoes when the first sole gets thin.

In the past 8 months over 20,000 American Motorists have followed their example and are saving \$50.00 to \$200.00 a year in tire expense.

Guaranteed 5,000 Miles without Puncture

Absolute freedom from tire worry—blowouts, punctures, rimcuts and rutwear eliminated—no matter whether your tires are old or new you should put on Durable Treads at once—they cover your tires from rim to rim—nothing can work in between—that's why we guarantee them as we do.

We Deliver Free—prepay the express and allow you to be the Judge. Durable Treads are easily applied in your own garage in 30 minutes without extra tools.

Special Discount to motorists in new territory on first shipment direct from the factory. Mail the coupon today and we'll send you full information, sample, and copy of signed guarantee without any obligation to you.

Mail This Today

COLORADO TIRE & LEATHER CO.
129 Tread Bldg., Denver, Colo.
19 Transportation Bldg., Chicago, Ill.
912 Woolworth Bldg., New York.

Gentlemen:
Please send me, without any obligation, full information, sample copy of signed guarantee for 5,000 miles, and Special Discount Terms.

Name

Address

My Tire Sizes are.....

My \$3.00 Exerciser \$1.00
Reduced to



Until further notice I will send one complete

Muscle Builder Outfit

to any reader of *Electrical Experimenter* upon receipt of \$1.00—just one-third the regular price. I will also include a complete body-building course of instructions containing 24 selected exercises. The **MUSCLE BUILDER** will meet the requirements of any person—weak or strong—man, woman or child. Can be used to exercise any muscle in the body.

A Chest Expander Also

with each outfit, I will give an extra handle, without charge, by which the **Muscle Builder** can instantly be converted into a most effective **Chest Expander** to be used for developing the chest and lungs. Take advantage of this opportunity while it lasts. Send your order today.

Prof. Anthony Barker
Studio 28, 110 W. 42d St., N. Y.

BRAIN VS. BODY IN THE RACE FOR SUCCESS

All you fellows who are devoting every bit of your time and attention to the cultivation of mental efficiency, do you ever

STOP

and ask yourself what it will avail you if you neglect your body? You think the brain is the all important essential in the race for your goal. Is it? Will your brain live longer than your body? Will your brain live up to its training and do good work if it has to be continually flashing messages from a neglected body, or registering protests from a disorganized stomach? Will the brain of a crooked, sore-winded, dyspeptic, or weak, puny, underdeveloped man justify the training it has had? Or will a brain weakened by youthful indiscretions be 100 per cent. efficient?

My book "Intelligence in Physical and Health Culture" will answer these questions in a way that will interest and surprise you. Send four cents in stamps to cover postage on a copy. Do it now!

LIONEL STRONGFORTH
Health and Strength Institute
Dpt. C125, Atlantic City, N.J.

Be a DOCTOR of CHIROPRACTIC

\$75 TO \$100 WEEKLY

The need now for Doctors of Chiropractic is tremendous—your opportunities are enormous. The public is awake to the wonderful advantages of Chiropractic (drugless healing). The possibilities to earn \$10,000 a year or more are here. There's a room for you—the field is wide open.

Learn at Home—no experience necessary—anyone can easily learn by our complete simplified, illustrated course and complete set of free charts in life-like colors.

5 Lesson Sections FREE—Absolutely without cost to you—great offer ever made. Write now for free facts.

Illustrated Book Free—Proves how you can become a Doctor of Chiropractic—tells all about Diseases and Chiropractic treatment and what you need to know to become successful in this dignified, prosperous profession. Write today—big free offer is limited. American University, Dept. 441, 162 N. Dearborn St. Chicago.



Murdock, B.Sc., and U. A. Aschwald, B.A. Cloth covers; 5 1/4 x 7 1/2 inches; 366 pages; 164 illustrations. Published by Macmillan Co., New York City. Price, \$2.75.

In this work the writers have endeavored to create a work suitable for the advanced "meter-man" and have succeeded admirably.

In the historical summary, they show early forms of measuring instruments and then take up each type, going on to explain carefully and at length with many formulae, the theory, as well as the practical details of each instrument up to and including various forms of demand supply meters.

Closing with chapters on magnetic permeability meters and a discussion of the post office box and slide wire bridges, the chapters form a well balanced and symmetrical whole. This book will no doubt find a place with all specialists on meter work, desiring to keep in touch with the best practice.

ELECTRICAL MEASUREMENTS AND METER TESTING. By David P. Moreton, B.S., E.E. Cloth covers; 4 1/2 x 6 3/4 inches; 266 pages; 191 illustrations. Published by Frederick J. Drake & Co., Chicago. Price, \$1.00.

In this work the author has succeeded in combining great clearness with conciseness and accuracy. The fundamentals are handled in a manner not surpassed by his treatment of higher and more technical alternating current measurements. Many analogies, combined with profuse illustrations, tend to make the work invaluable, alike to the layman and practical electrician in search of knowledge on the subject of electrical measurements.

Starting with the idea of giving the reader a good grasp on the principles of electricity, the author carries him forward in short steps to a full knowledge of all methods of measuring electricity, making in all, a book worthy of a position in every electrician's bookcase.

ELECTRICITY FOR THE FARM. By Frederick Irving Anderson. Cloth covers; 5 1/4 x 7 1/2; 266 pages; 50 illustrations. Published by Macmillan Co. Price, \$1.25.

Taking a really difficult subject, the author has treated it in an exceptionally clear manner. Starting off more like fiction than a technical treatise, he shows the great changes on the farm made possible by a small electric plant. He proceeds with an elaborate treatment of water-wheel installations, leading up to the electrical equipment, which is treated at some length.

The final chapters deal with gas engine and wind power as applied to electric generators. With this book at hand, the farmer can start to install an electric plant with full confidence of success.

HOW TO PASS U. S. GOVERNMENT WIRELESS LICENSE EXAMINATIONS. By E. E. Bucher; 70 pages; 37 illustrations; size, 9x5 1/4 inches; paper bound. Price, 50 cents. Published by Marconi Publishing Corporation, New York City.

This book, arranged in the form of a catechism, fills a long-felt need. Answering as it does 118 questions of actual bearing on the subject, it is an invaluable help to the radio amateur who desires to pass the U. S. Government wireless license examinations.

The questions are answered in a clear, easily understood, manner not untouched with a certain amount of technical terms. The book treats of the different parts of a radio installation in order and covers each quite thoroughly.

It gives numerous formulas for the calculation of the various currents and apparatus. The book appears to have been written in a very hurried manner as the errata is rather large, and in fact it contains a minor mistake in itself. However, this book should find a large demand with students of radio phenomena who desire a better grasp on the subject in a practical way.

YEAR BOOK OF WIRELESS TELEGRAPHY AND TELEPHONY FOR 1915. Published by Marconi Publishing Corporation, New York City. Size, 8 1/2 x 6 inches; 1,000 pages; 32 illustrations; cloth bound. Price, \$1.50.

The year book for 1915 has just made its appearance and it surpasses the 1914 edition both in size and quality of its contents. It contains as usual the complete list of ship and land stations of the world and the laws and regulations of the various countries on radio-communication.

It also contains numerous formulas and tables invaluable to the commercial operator as well as to the amateur and deserves a position on every experimenter's book-shelf.

The chapter on wireless telephony is very brief and treats of the various systems in a general way, going into few details. However, it treats of the entire history of wireless telephony in some detail, as to discoveries of the various experimenters in this line, etc.

The various articles by prominent men in the field of radio-communication are of special interest and timely. They deal with the effects of wireless telephony on the present European conflict and

The newest ideas in cases are yours to choose from.

Gold strata case. Guaranteed for 25 years.

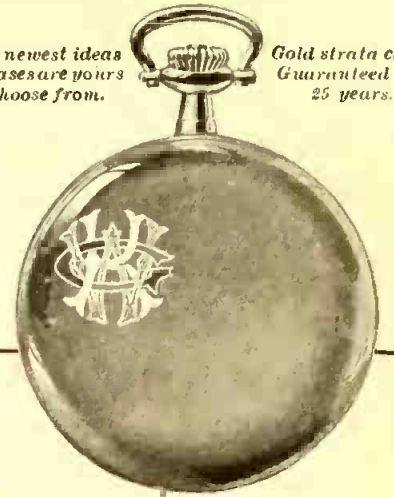

The Burlington Smashes All Watch Competition Look!

19 Ruby and Sapphire Jewels—
Adjusted to positions—
Adjusted to temperature—
Adjusted to isochronism—
25-year gold strata case—
Genuine Montgometry Railroad Dial—
New Ideas in Thin Cases.

Only \$2.50
And all of this for \$2.50—only \$2.50 a month for the masterpiece of watch manufacture—direct to you—positively the exact price that the wholesale dealer would have to pay. We do not care to quote these prices here, but write—write before you buy. Think of the high-grade, guaranteed watch we offer here at such a remarkable price. Indeed, the days of exorbitant watch prices have passed. Write today.

The Newest Cases

In our new watch book, that we will send to you free and prepaid, you will see illustrated the newest ideas in watch cases. The latest triumphs of the master goldsmiths. Notice especially the Inlay Enamel Monograms, Block and Ribbon Monograms, Lodge Emblems and Diamond Set Cases. All offered direct to you on this startling offer. Send the coupon today.

See It First!

You don't pay a cent to anybody until you see the watch. We won't let you buy a Burlington watch without seeing it. Hold it in your hand and admire it. Notice the design, handsomely shaped—aristocratic in every line. Then look at the works! There you see the pinnacle of watch-making. You understand how this wonder timepiece is adjusted to the very second!

Free Watch Book

Get the Burlington Watch Book by sending this coupon now. You will know a lot more about watch buying when you read it. You will be able to "steer clear" of the double-priced watches which are no better. Send the coupon today for book and our offer.

Burlington Watch Co.
19th St. and Marshall Blvd.
Dept. 3389 Chicago, Ill.

Please send me (without obligations and prepaid) your free book on watches with full explanation of your cash or \$2.50 a month offer on the Burlington Watch.

Name _____
Address _____
Burlington Watch Co.
19th St. and Marshall Blvd.
Dept. 3389 Chicago

500 TYPEWRITERS AT \$10 TO \$15

Typewriter Prices smashed Underwoods, Remingtons, Royals, L. G. Smiths, Fox, etc.—your choice of any standard factory rebuilt machine at a bargain. Everyone perfect and guaranteed for three years including all repairs. My free circular tells how to save 40 per cent to 60 per cent on each machine.

Write for it. C. E. GAERTE, President
CARBON TYPEWRITER EXCHANGE, DEPT. 627, CHICAGO, ILLINOIS

Here's YOUR Chance to Learn

DRAFTING

This Complete \$15 Drawing Outfit and Full Instructions in Mechanical Drawing

FREE

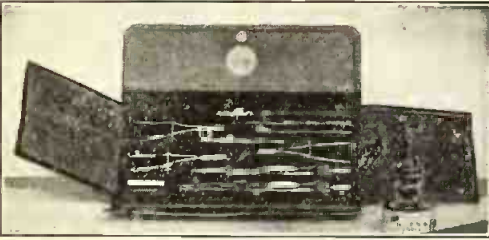

There's a good job waiting for you. The country is facing greater prosperity than it has ever before experienced. Far-seeing men are getting ready for boom times. Get this training now and share in the coming prosperity. We make the way plain.



CHARLES W. MOREY
President of the College
and Head of a Large Chicago
Firm of Civil, Mechanical
and Electrical Engineers and
Contractors.

Men Wanted AT BIG SALARIES

This is a rare chance for a few wide-awake young men. On account of the rapidly increasing demand for trained draftsmen Pres. Morey has issued orders that instructions be furnished to a limited number of young men who are inclined along engineering or architectural lines. Read about this great offer below—then mark and mail the coupon.

STUDY AT HOME Devote your spare hours for a short time only and learn this profitable and pleasant profession, and get in the class drawing the big pay envelope. Hundreds of men are in daily attendance at this old established college. In your own home you can do the same work these men are doing, and the same experts that teach them will guide you toward the big job. These well-known engineers prepare your instruction matter. Your work is examined and approved by them. They know exactly the practical training you need and they train you. No books to sell. Live, up-to-date blue prints of work in actual construction. In your own home you work with plans of machinery, buildings, steel works, etc., actually being constructed in Chicago, New York and other large cities.

Electrical Drafting and Design

No other similar correspondence course in America has a resilient college of National reputation back of it, nor a faculty of active experts actually engaged in municipal and corporation engineering work. These men know exactly the kind of training you need because they are in constant charge of big work.

\$45 COURSE FREE IN MECHANICAL DRAWING

This College has set aside a limited number of Free Scholarships and will give the regular \$45 Course in Mechanical Drawing Free with any one of the Home Study Courses named in the coupon below—this is in addition to the complete \$15 Drawing Outfit which is also furnished to students free. Take advantage of this unusually liberal offer today, as it will be withdrawn when the allotted number of Free Scholarships has been awarded. It costs you nothing to get full information. No obligation on you.

ACT NOW—FILL OUT COUPON TODAY

- Electrical Drafting
- Machine Drafting
- Architectural Drafting
- Structural Drafting
- Civil Engineering (1060)
- Builders' Course
- Plan Reading
- Estimating
- Sheet Metal Drafting
- Surveying

Name.....
 Address.....
 Town.....State.....
 College or Home Study Course.....

CHICAGO TECHNICAL COLLEGE
1060 LAKE VIEW BLDG. CHICAGO, ILL.

the latest developments in long-distance wireless communication. The adaptation of wireless telegraphy to meteorology and surveying are treated on in an interesting manner.

The book likewise contains lists of radio societies, wireless telegraph companies, the latest books and periodicals available on the subject, a glossary and dictionary of technical terms, etc.

Presenting in one volume the entire history of wireless telegraphy as well as the latest advances in the art it fulfills its mission as a year book in a satisfactory manner.

THE WIRELESS TELEGRAPHIST'S POCKET BOOK by Dr. J. A. Fleming. Red leather covers, gilt edges, 348 pages; 39 illustrations; 4½x7½ inches. Published by the Wireless Press, London, England, 1915. Price \$1.50.

This is a much desired pocket size volume of extreme value to the radio operator and engineer, whether for theoretical or practical consideration. The author is one of the best known writers and scientists in the wireless field, and has here presented a general clean-up on the necessary measurements and calculations occurring in wireless telegraph and telephone engineering. Sufficient diagrams and illustrations are incorporated to make the book of great practical value.

The section covering the different losses and over-all dimensions as well as the efficiency of the individual apparatus making up a complete wireless transmitting set, is of extreme value and has not been covered heretofore in most text-books, which presume to deal thoroughly with the subject. Some of the subjects covered include a considerable amount of mathematics up to Calculus, and this section ends with electrical and other units, dimensions, etc. This is followed by chapters on high frequency and voltage measurements; capacity calculations and absolute measurements by the bridge method; frequency and cymometer measurements; aerial and etheric wave radiation, covering the calculation and determination of radiation resistance and decrement; transmission and transmitting circuits, as well as receiving circuits, with a final section covering routine station practise for radio operators. The book contains an appendix of valuable mathematical tables, including logarithms, circle dimensions, etc.

All in all, this neat volume appears to possess great merit and it should find a ready sale among all radio men who wish to have at their fingers end the latest concise data on this important branch of science.

There are several sections of the book which seem as though they might have been made larger, even if other sections had to be cut down somewhat. This pertains particularly to the opening chapters, which deal with mathematics. Manifestly it is impossible to cover the subject of mathematics in a few pages, and while to many users of this handbook the mathematical notes will be found useful, it would be just as well to have left them out or made them cover less ground, as those who are interested sufficiently can procure numerous treatises at a nominal cost, covering mathematics very thoroughly and completely.

BY WIRELESS PHONE FROM AR- LINGTON TO PARIS.

(Continued from page 393.)

Paris and also in Honolulu.

"We have now heard from all our expeditions, and it is interesting to note that the circle of the area covered by these expeditions was about 10,000 miles in diameter. Never in history was such an expedition ever undertaken as was this one."

"How long was it before Webb in Arlington was able to establish communication with Shreeve in Paris, and what test words were used?" Mr. Carty was asked.

"Owing to the very limited time at their disposal, it was necessary to cable the exact minute during which the Eiffel Tower plant was available," he replied, "and in those few seconds Webb did his talking. Signals had been previously arranged, first by numbers, and then followed by words. Shreeve was to cable what he got after each test—that is, provided he got anything—and, as you know, the signals were heard on three different nights. Owing to the fact that there is now in existence only one set of transmitting instruments, and that at Arlington, the talk, of necessity, as was the case with San Diego, Honolulu and the other places reached by the expedition, had to be one-sided."

[Editor's Note.—For details and illustrations of apparatus used at Arlington in Honolulu talk, see November, 1915, issue of *The Electrical Experimenter*.]

NEW BOOKS

HIGH FREQUENCY APPARATUS

Its Construction and Practical Application

By Thomas Stanley Curtis
Price \$2.00 postpaid

This new book tells you all about *Electricity in Stagecraft*, *Electricity in Horticulture, Etc.*, and shows you how to make and use the apparatus for these experiments.

FREE TECHNICAL ADVICE

When you order an electrical or a mechanical book, do you always get just the treatment of the subject that you desire? We maintain a Department of Technical Advice to aid you in the selection of the right book for a given purpose.

The service is free; will you tell us what subjects interest you and let us help you to select a library, one book at a time if you wish?

A Stamp brings our literature promptly.

TECHNICAL PRESS ASSOCIATION
836-C Aeolian Hall, NEW YORK

THE PANDICULATOR



This University discovery is the most important health invention of the century. It re-makes and rejuvenates the Human Body. It produces normal spines. It frees impinged and irritated nerves, corrects contracted muscles, shortened ligaments; eliminates congestion, improves circulation and drainage of the body. IT WILL INCREASE THE BODY'S LENGTH.

THE PANDICULATOR CO.
Cleveland, O.

BOYS! Best Boy's Magazine in the world at the price DO YOU LIKE RATTLING GOOD STORIES!



Are you interested in baseball and athletics, electricity, mechanics, photography, carpentry, stamps and coin collecting, amateur journalism, gardening and pets? If you are sit down right now and send a quarter for a year's subscription to *Boys' Companion* a large 32 page illustrated boys monthly magazine. It is chock-full of the very best boys' stories, clean and wholesome, full of life and action, and has regular departments every month on all the above subjects besides special articles of great interest to boys. ALL BOYS WANT IT! If you will send 25 cents at once for a year's subscription we will mail you a copy of *Connie Mack's* new Rookie.

"The Secret of Success in Baseball" FREE. One year 25 cents, half year 15 cents, Three months for 10 cents. *Boys' Companion*, 104 South La Salle Street, Chicago, Ill.

Show Card Writers Earn \$80.00 to \$200 a Month—LEARN FREE



We will furnish a thorough course in Show Card Writing and Lettering absolutely free to introduce our colors, if you will purchase an assortment of Alpha Colors to use while practicing. Particulars for stamp. ALPHA COLOR COMPANY, Inc. Dept. T, 81 E. 125th St., New York

HIGH FREQUENCY CURRENTS AND APPARATA.
(Continued from page 405.)

experiments with high frequency currents will be found described in the series of many excellent books listed at the end of this discourse. It can also be said that we of to-day know very little about these high frequency currents and their possibilities. Nikola Tesla has done more in this direction than any other person, as can be readily judged from the fact that over 15 years ago he successfully produced sparks 100 feet long resembling in volume and sound the lightning discharges we have all seen in nature (not imitation ones). It is hoped that this article may serve to kindle the spirit of research along these lines in the young experimenter's mind, and he surely will be amply rewarded for any discoveries he may make in this little-understood branch of electrical science, which bids fair to unlock the door to a future electrical era of which our generation has no reasonable conception at this time.

BIBLIOGRAPHY.

Books Recommended.

The Theory and Design of Induction Coils. By H. Armagnat.

High Frequency Currents (Electro-therapeutical). By Dr. Frederick Finch Strong.

Experiments with Alternating Currents of High Potential and Frequency. By Nikola Tesla.

Electricity at High Pressures and Frequencies. By Henry L. Transtrom.

Wireless Telegraphy and High Frequency Electricity. By Prof. H. LaV. Twining.

Wireless Telegraphy. (Covers Tesla's wireless transmission of power patents.) By Charles Henry Sewall.

Articles Published in Back Numbers of Electrical Experimenter.

A 1/4-kw. Tesla Coil. Page 73, September, 1913.

Currents of Ultra-High Frequency and Potential. Page 151, February, 1914.

A Tesla Transformer for One-Inch Spark Coils. Page 187, April, 1914.

Electro-therapeutics and High Frequency Apparatus. Pages 20-23, June, 1914.

Some Experiments with High Frequency Currents (in two parts). Page 24, June, 1914; page 119, December, 1914.

High Frequency Currents—Explanation and Apparatus (in two parts). Page 68, September, 1914; page 84, October, 1914.

A Miniature High Frequency Outfit. (Construction details given.) Page 123, December, 1914.

Spectacular Discharges and Large Tesla Coils (36-inch spark apparatus. Construction details given). Pages 54-55, June, 1915.

"HOME ELECTRICAL" WINS AWARDS AT WORLD'S FAIR.

The 900,000 persons who have inspected the "Home Electrical" display at the Panama-Pacific International Exposition will be interested to know that the General Electric Co.'s exhibit has been awarded two gold medals by the international jury of awards. One of the gold medals was awarded for the high educational value of the display, while the completeness of the exhibit and its drawing power as an attraction carried off the other gold prize.

The "Home Electrical" presents a full-sized model home of Spanish-California bungalow design, in which world's fair visitors see a practical demonstration of how electric energy performs all the household labors and adds to the comforts of living.



Can You Accept a Position Paying \$125 to \$300 a Month?

ARE your services in demand today. Have you the training that equips you to hold a position paying \$125 to \$300 a month?

Have you the same knowledge as the man who gets the fat pay envelope? If you are ambitious—send the coupon below and find out about the opportunities that await you in the profession of Signal Engineering. Salaries are paid to men who know. You can get just the kind of training you need to accept one of the big jobs, right in your own home—during your spare time. We need men. Do not delay. Send the coupon today for the book that tells you all about it.

Be a Signal Engineer

Be the man who gets the fat pay envelope. The profession of Signal Engineering is only in its infancy. There are thousands of miles of block signals to be installed. Signal Engineers, supervisors, inspectors and foremen are required to superintend this installation. Hundreds of maintainers and better men are needed to maintain the systems already in use.

Your duties may take you from coast to coast. Railroad men are always in a fortunate position to travel and see the world because free transportation is liberally awarded. You can accept a position where you will be located steadily at one place, if you prefer—the position of authority—the high place and fat pay envelope may be yours. Send coupon for free Signal Book.

\$125 to \$300 a Month

That is an ordinary salary for Signalmen—many Signal Engineers make much more. In the Signal Department, supervisors, inspectors, maintainers, battery men, positions of authority paying from \$75.00 a month up, all open to the men who have had the kind of training you can get right in your own home. Even while you are learning you may hold one of the positions in the Signal Department under a Signal Engineer.

Send Coupon for Big New Book

Put your name and address on the coupon or on a letter or a post card now, and send it to us. Absolutely no obligations of any kind. We will send you our big new Book absolutely free, and prepaid. Read about this fascinating profession. Read about the opportunities that await you. The book is free. Send the coupon for it now—it's the first step toward the realization of your ambition. Get your name and address in at once.

Department of Signaling

Room 3389, 1810 Wilson Avenue, Ravenswood Station, Chicago

We Need Men

The profession of Signal Engineering is calling to ambitious men. Our ranks are not overcrowded. There are opportunities—golden ones, awaiting the men who answer the call.

Block signal systems are no longer in the experimental stage. All over the country they are being installed. Some States have legislated to compel the railroads to install systems immediately. In our profession you will have the chance you have been looking for. We are calling you. Take immediate advantage of this wonderful opportunity. Don't fail to send the coupon today for our big free Signal Book and full particulars. Do it NOW.

Two Big Outfits FREE

Complete signal Engineer's Outfit and complete Draftsman's Outfit given away absolutely free to our students

Department of Signaling

Room 3389
1810 Wilson Avenue
Ravenswood Station
Chicago, Illinois

Gentlemen:—Please send me absolutely free and prepaid your big new book on Signal Engineering. Also full particulars about your great special free outfit offer. It is distinctly understood that I assume no obligations of any kind.

Name.....

Address.....

Age..... Occupation.....

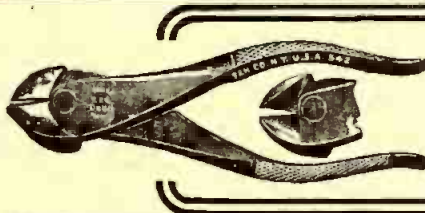

Cuts the toughest wire with the least strain "RED DEVIL" NIPPER No. 542-6"

1 lb. handle pressure gives 20 lbs. cutting pressure. Hand-honed, "stay sharp" cutting edges, slip-proof, scientifically shaped handles. Sample 85c postpaid.

MECHANIC'S TOOL BOOK FREE

SMITH & HEMENWAY CO., Inc. 153 Chambers St. New York City

The Newest Thing in Flashlights

Your watch on one end of your chain, your WATCHLITE on the other.

Not merely a novelty, but a useful, serviceable flashlight.

Bright Star Battery Co.

Factory and Main Office:
NEW YORK

Branches:
CHICAGO MONTREAL

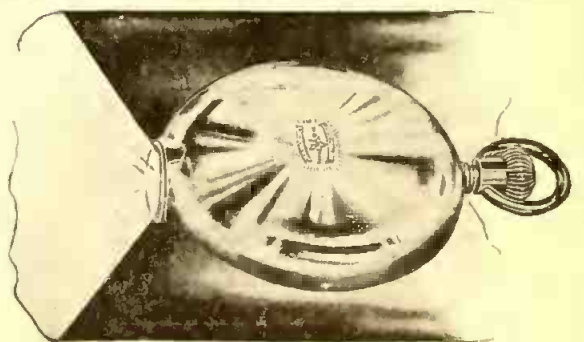

"WATCHLITE"

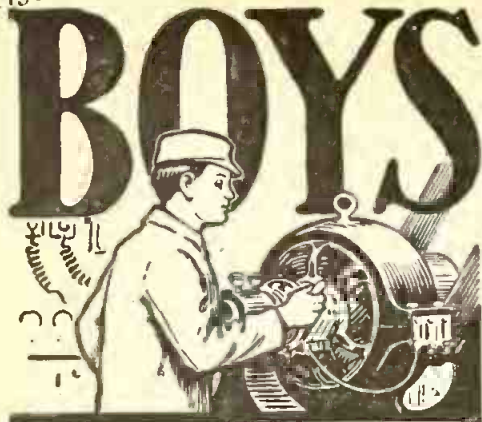

Big Money in Electricity

The electrical industries offer wonderful opportunities for boys with a liking for electricity. The salaries paid to trained men are large—promotion comes rapidly, and, best of all, the profession is not overcrowded.

The opening of new lines, from time to time, (such as wireless telegraphy and telephony), promise attractive and paying fields to those who wish to specialize. The *will to do* and *Special Training* will bring success to you.

The International Correspondence Schools of Scranton can help to make you an expert in electrical work. Hundreds of boys have already won success through I. C. S. help. You can do the same. Everything is made so clear that you can learn in your spare time, regardless of where you live or what you do. No books to buy.

There's big money in electricity. Get after it by marking and mailing the attached coupon today. Finding out costs you nothing.

Mark the Coupon—NOW

INTERNATIONAL CORRESPONDENCE SCHOOLS

Box 1071 B, SCRANTON, PA.

Explain, without obligation to me, how I can qualify for the position before which I mark X.

- | | |
|--|--|
| <input type="checkbox"/> Automobile Running | <input type="checkbox"/> Stenog. & Typewrit'g |
| <input type="checkbox"/> Motor Boat Running | <input type="checkbox"/> Bookkeeping |
| <input type="checkbox"/> Electrical Engin'er'g | <input type="checkbox"/> R. R. Accounting |
| <input type="checkbox"/> Electric Lighting | <input type="checkbox"/> Good English for Ev'ryone |
| <input type="checkbox"/> Electric Railways | <input type="checkbox"/> Civil Service |
| <input type="checkbox"/> Dynamo Running | <input type="checkbox"/> Architecture |
| <input type="checkbox"/> Telep. & Teleg. Eng. | <input type="checkbox"/> Contracting & Build. |
| <input type="checkbox"/> Mechanical Eng'g | <input type="checkbox"/> Structural Engin'g |
| <input type="checkbox"/> Mechanical Drafting | <input type="checkbox"/> Plumb'g & Heat'g |
| <input type="checkbox"/> Shop Practice | <input type="checkbox"/> Civil Engineering |
| <input type="checkbox"/> Steam Engineering | <input type="checkbox"/> Salesmanship |
| <input type="checkbox"/> Mine Fore. & Supt. | <input type="checkbox"/> Advertising |
| <input type="checkbox"/> Chemistry | <input type="checkbox"/> Agriculture |

Name _____

Street and No. _____

City _____ State _____

Present Occupation _____

TO FOIL SUBMARINES WITH UNDERSEA SEARCHLIGHTS.

(Continued from page 392.)

this end the inventors make use of an observation tube. This can be any of the well-known devices for seeing beneath the surface, but they prefer the *mariscope*, shown at 16, arranged adjacent to the tube 10 and being curved at right angles 17 and 18 at top and bottom. A lens 19 is provided at the lower extremity of the tube, and opposite this is an inclined mirror 20, with another above, 21, at the upper end of the tube; from this the rays are refracted to the sight hole 22, at the end of the tube 17, so that when any object appears in the *illuminated field* its image, or at least a shadow of it, will be caught by the *mariscope* and seen in the sight opening 22.

As soon as they had devised a means of locating an object in the path of a vessel to be destroyed the inventors next foresaw the necessity for having some means at hand of attaining this end. They devised, therefore, a torpedo tube 23 at the bow of the vessel and adjacent to the means for locating the object. Our illustration herewith shows a torpedo being discharged. The inventors would have it understood, however, that their invention does not lie in any detail of the torpedo tube or of its location, but that any means of discharging a torpedo or other missile from the bow or from the submerged part of a vessel can be employed in connection with their means of *locating the object* to be destroyed and their invention of an electrical device for *exploding a discharged torpedo* when it hits or reaches the vicinity of the object to be destroyed.

As illustrated, the torpedo 24 has connecting wires 25 with any usual or preferred sparking device, wound into a cable 26, which is carried on a reel 27. The terminals 29 on board the vessel are connected by means of two wires with a source of supply of electricity provided with a controlling key 30. When it is seen that the torpedo is in the immediate vicinity of the submarine, mine or other object it can be immediately exploded by closing the circuit.

"We have shown our apparatus attached to the bow of a vessel," said Professor Parker, "but it is obvious that it can be applied to any other part as well, and thus provide a certain means of defense. As a means of offense the importance of the invention will be readily seen, and it will also be noticed that if several vessels equipped with the helioscope and mariscope were approaching abreast a mine field or fleet of submarines a very extensive field would be illuminated and placed under observation, so that the object of danger could easily be destroyed. Furthermore, it is apparent that where the objects of danger are readily located a surface vessel, because of its greater speed and mobility, can easily avoid such objects, even if it cannot destroy them."

ELECTRIC BRANDING IRON.

For branding hams, bacon and other packinghouse products, a new electrically heated iron has been invented, which receives its current from an ordinary lamp socket at a cost of but one-fourth of a cent an hour.

THE UNITED STATES ADVISORY BOARD AND ITS PERSONNEL.

(Continued from page 399.)

Society of America. He is also a member of other scientific societies, including the Aerodynamic Commission of the Aero Club of America. Besides his other numerous activities in the realm of flying machines and allied devices, he has investigated the determination of air pressure on arched

surfaces, and is the inventor of a stepped aeroplane that is the lightest machine so far built, it is said.

From the realm of mining engineering the Naval Advisory Board has been happily favored with the selection of two eminent specialists nominated by the American Institute of Mining Engineers. These gentlemen are William Lawrence Saunders and Benjamin Bowditch Thayer, both of New York City. Mr. Saunders is a mining engineer of great prominence and was born in Columbus, Ga., in 1856. He graduated from the University of Pennsylvania and for some time was in charge of the hydrographic work of the National Storage Co. He is serving at this time as president of the Ingersoll-Sargeant Drill Co., the Imperial Tool Co., and the Ingersoll-Rand Co., and at one time he was editor of *The Compressed Air Magazine*. He is a specialist in the design of compressed air machinery and has invented many important devices in this field. Mr. Thayer was born in San Francisco and graduated from Harvard University. He is a well-known mining engineer and is president of the American Institute of Mining Engineers, and, industrially, he is president of the Anaconda Mining Co.

This brilliant staff of specialists includes two all-around men of science, as selected by the American Chemical Society, in the persons of Dr. Leo H. Baekeland, of Yonkers, N. Y., and Professor William R. Whitney, of Schenectady, N. Y. As a chemist of repute Dr. Baekeland is well known. He has also produced several important industrial productions based on chemical affinity. He was born at Ghent, Belgium, in 1863 and graduated from the University of Ghent, where he served later as Assistant Professor and the Associate Professor of Chemistry. He also has been Professor of Chemistry in the higher Normal School at Bruges. He is also the inventor of the well-known Velox gaslight paper so widely used by amateur and professional photographers, and besides invented the famous Bakelite used very extensively for all kinds of electrical and other insulating requirements. Professor Whitney was born at Jamestown, N. Y., in 1868 and graduated from the Massachusetts Institute of Technology, where he served afterward as Instructor, Assistant Professor and finally as Professor of Chemistry. The greatest electric corporation in the world—the General Electric Co.—now counts him as one of its most valued men, and he is the director of the research laboratory of that immense industrial and scientific organization, which has solved more problems of an electrical and other nature than probably any other industrial concern of similar age.

From the field of electro-chemistry there has been contributed to the Board two able authorities: viz., Professor Joseph William Richards, of South Bethlehem, Pa., and Lawrence Addicks, of Chrome, N. J. Professor Richards is the instructor in metallurgy and mineralogy at Lehigh University. He was born at Oldbury, England, in 1864 and his early education was obtained in the public schools of Philadelphia. He was honored with degrees from Lehigh University and later spent considerable time in advanced study at Heidelberg, Germany. Mr. Addicks is considered an authority on the metallurgy of copper, and acts in the capacity of superintendent of the plant of the United States Metal Refining Co. at Chrome, N. J. He was born at Philadelphia in 1878 and graduated from the Massachusetts Institute of Technology with the degree of Bachelor of Science in mechanical and electrical engineering. He has held important positions as consulting engineer

and is very well known in his chosen line of work as a man of great ability and resource.

HOW THE "WIRELESS WIZ" CELEBRATED XMAS.
(Continued from page 397.)

run out again should the current be fed to the third rail of the side-track. The track switch is pulled into the straightway by operating the switch 10. The express train will then continue to run around and may be reversed and backed into its station, 'B.' The freight train can be backed off the siding by closing the switch 3, and by means of the current reverser, X², can be made to go around the track. It is understood that by properly manipulating these switches and working the rheostat R that some quite effective situations may be created.

"An electric whistle was mounted in one of the stations, and this was operated by a push button before the train was started.

"The electro-magnetic stops are made as depicted in sketch C, and consist merely of a bent strip of brass or small wood box supporting an electro-magnet, to which is pivoted an arm, I, which is raised into position by the electric current in the coil, to throw the current reverser on the train in the usual manner.

"The Christmas tree was supported from the ceiling by means of a turnbuckle, and on the bottom of the trunk were mounted two large wooden pulleys, as in this figure, D. A friction drive from the motor, M, and the pulley, G, gave sufficient reduction gearing, so that the tree would run very slowly. I had concealed about two dozen tiny lamps in the foliage of the trees, which were fed through a commutator (see D), arranged as detailed, to cause the lamps to flash; furthermore, some of the trimmings were coated with calcium sulphide, which glowed in the dark after the lights were shut off.

"The second pulley, H, by means of a belt-drove pulley, I, in the reverse direction to that of the tree. The shaft of this pulley was fastened to the drum in the lighthouse, on which was mounted colored sheets of celluloid. The body of the lighthouse was made of stiff cardboard, and in the top was mounted a high candle-power tungsten lamp. The wires from this lamp and the revolving cylinder were arranged as in sketch E. The rocks scattered around the scene consisted of 'willemite' that glowed under the effects of the ultra-violet light. This light was generated by means of an arc lamp (made as in Fig. F) and hung behind the rear screen, which had a half-moon shaped hole cut in it and cheesecloth passed over it. The sea was made of thin, blue cloth on which was laid strips of cotton batting. A rotating fan underneath the platform caused upheavals of the cloth, and the cotton rolling back and forth gave the effect of rollers breaking on the rocks. The scenery was made from ordinary sheets, and the mountains, etc., marked in with charcoal."

"I suppose you used the old scheme of the microphone to open the doors," I broke in.

"Yes," he replied, "the same old thing, except that the relay, after once closing, kept the contacts closed and supplied current to the motor until the door was fully opened, when the circuit was broken by means of two springs; here's the hook-up. I'll mark it Fig. G."

"Well, I'll never forget that scene," I remarked as I was leaving.

"Yes, and I'll never forget the job I'll have in cleaning up in time for the New Year's party," grunted the "Wiz."

Free!

Complete Set of Drawing Instruments

YES, I will give you this complete set of drawing instruments absolutely free. They are regular working instruments—the kind I use myself and they do not cost you a penny. And besides the instruments in this exquisite plush lined leather case, I will give you absolutely free a 20x25 inch drawing board, a 24 inch T-square, a 12 in rule, a supply of drawing paper, two triangles, a French curve, pencils, erasers, thumb tacks, etc., etc. A complete draftsman's working outfit. And I give it to the men who get my personal instruction absolutely free.

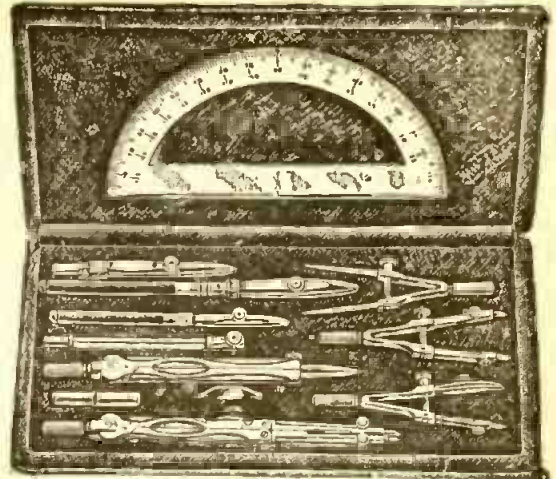

Be a Draftsman!

Draw \$125.00 to \$175.00 Per Month

There is an urgent demand for skilled draftsmen. Companies are issuing calls every day for men to fill positions paying from \$125.00 to \$175.00 per month. Work is light, pleasant and profitable.

Chief Draftsman Will Instruct You Personally

Pay as You Wish!

WHAT I want is the right kind of men. Don't bother about the expense. I charge a very small fee for training you to be an experienced draftsman. You can pay the small cost as suits you best. My object is to develop expert draftsmen.

I am Chief Draftsman of a large and well known firm. I have been doing the highest paying expert drafting work for a quarter of a century and I know the kind of training that is demanded from the men who get the big salaries. I will give you personal instruction, deal individually with you and give you up-to-date, practical working plans just as your ability and advancement require. I train you by giving you actual work—practical work, the kind that you must be able to do in order to hold permanent, big paying positions. I will give you my individual instruction. If your work is right, I will advance you rapidly. If it is wrong, I will show you where, and make you do it right, and do all I can to make you an expert draftsman and designer in a short time. Write today without fail.

Send Coupon For My Big New Book

Put your name and address on the free coupon or a letter or a post card and send it to me today. I will send you absolutely free and prepaid my new book "Successful Draftsmanship," and the great special offer that I am now making on which you get the \$15.00 Draftsman's Working Outfit absolutely free. You assume no obligations of any kind in sending in the coupon. Get in line now for a big paying position. Getting the book and full particulars of the special offer is the first step.

Chief Draftsman Dobe
Engineer's Equipment Co., Inc.
Div. 3389 Chicago, Illinois



Chief Draftsman Dobe
Engineer's Equipment Co., Inc.
Div. 3389 Chicago, Illinois

Without any obligation on me whatsoever, please mail your book "Successful Draftsmanship," and full particulars of your liberal "Personal Instruction" offer to a few students. It is understood that I am obligated in no way whatever.

Name.....
Address.....

You Can Only secure the best in FLASHLIGHTS and BATTERIES by insisting that



"Cigarette"

this trade-mark is on flash-light-case and battery. If your dealer cannot supply you with our product write directly to us for Catalogue A2.



Beacon Flashlights and Batteries are made in a wide variety of styles and shapes but only one quality—THE BEST.



"Short-Circuit Proof"



"Ideal Fountain Light."

Beacon Electric Works of National Carbon Co., 118-20 DUANE STREET NEW YORK
BRANCHES: CHICAGO, SAN FRANCISCO

SLICING COSTS FOR YOUR BENEFIT



In announcing these wonderful prices it is with the absolute knowledge that our readers are offered the lowest prices for standard Magazines that it is possible to obtain anywhere. Only by special arrangement with the publishers are these prices possible, but to take advantage of them, you must act quickly. Don't delay, do it now. This offer is so good that of necessity it must be limited in time. Just think of buying standard Magazines at reduced prices in time for Xmas Presents, and they certainly make ideal gifts being a constant reminder for a whole year of a considerate friend. Just glance over our wonderful prices, and see how we enable one dollar to bring you two dollars' worth, and then make up your list. Just fill out the coupon, enclose the money and make sure you tell us what Magazines you want, and where they are to go. It is not necessary that all go to the same address. But be sure you do it now. To-morrow means you may forget and lose this wonderful opportunity. All prices quoted are for subscribers in U. S. A. only, Canadian and Foreign subscriptions require additional postage.

THESE SPECIAL PRICES
HOLD GOOD ONLY
TILL JAN. 1,
1916.

USE THIS COU-

SOME POPULAR AND MONEY SAVING CLUBS

For the Scientist

ELECTRICAL EXPERIMENTER.	Cost to you by the copy	Our Price
Popular Science.....	\$4.80	\$4.10
Illustrated World.....		

For the Woman

ELECTRICAL EXPERIMENTER.....	Cost to you by the copy	Our Price
Ladies' World.....	\$3.60	\$2.70
Woman's Home Companion...		

For the Boy

ELECTRICAL EXPERIMENTER.	Cost to you by the copy	Our Price
American Boy.....	\$3.00	\$2.50
Boys' Magazine.....		
Boys' World.....		

For the Fiction Reader

ELECTRICAL EXPERIMENTER.	Cost to you by the copy	Our Price
Metropolitan.....	\$4.80	\$2.95
McClure's.....		

For the Boy

ELECTRICAL EXPERIMENTER.	Cost to you by the copy	Our Price
St. Nicholas.....	\$7.30	\$5.50
Youths' Companion.....		
Boys' World.....		

For the Fiction Reader

ELECTRICAL EXPERIMENTER.	Cost to you by the copy	Our Price
McClure's.....	\$4.80	\$2.95
Everybody's.....		

For the Home

ELECTRICAL EXPERIMENTER.	Cost to you by the copy	Our Price
Woman's Home Companion.....	\$9.00	\$6.75
Country Life in America.....		
L'Etude.....		

For the Business Man

ELECTRICAL EXPERIMENTER.	Cost to you by the copy	Our Price
Literary Digest.....	\$9.40	\$6.15
Review of Reviews.....		

For the Sportsman

ELECTRICAL EXPERIMENTER.	Cost to you by the copy	Our Price
Field and Stream.....	\$4.80	\$4.35
Yachting.....		

For the Farm

ELECTRICAL EXPERIMENTER.	Cost to you by the copy	Our Price
Farm Journal.....	\$2.95	\$2.10
Farm and Fireside.....		
Poultry Success.....		

SEND YOUR ORDERS TO "CIRCULATION DEPARTMENT"

EXPERIMENTER PUBLISHING CO., Inc.
233 Fulton Street, New York City, N. Y.

SLICING COSTS FOR YOUR BENEFIT



These Special Prices Hold Good Only Till Jan. 1, 1916

MAGAZINE BARGAINS

Cost per year by separate copy. Our rate per year.

Life and Electrical Experimenter.....	\$6.40	\$5.30
National Monthly and Electrical Experimenter.....	2.40	1.35
McClure's Magazine and Electrical Experimenter.....	2.40	1.75
The Ladies' World and Electrical Experimenter.....	2.40	1.50
Metropolitan and Electrical Experimenter.....	3.00	2.00
Motion Picture and Electrical Experimenter.....	2.40	1.80
National Magazine and Electrical Experimenter.....	4.20	2.75
Ainslee's and Electrical Experimenter.....	3.00	2.15
Leslie's Weekly and Electrical Experimenter.....	6.40	5.10
Judge Weekly and Electrical Experimenter.....	6.40	5.10
Film Fun and Electrical Experimenter.....	2.40	1.50
Collier's and Electrical Experimenter.....	3.80	2.75
Popular Science and Electrical Experimenter.....	4.05	2.00
Scribner's and Electrical Experimenter.....	4.20	3.30
Grit and Electrical Experimenter.....	3.70	2.45
Pearson's Magazine and Electrical Experimenter.....	3.00	1.55
Farm Journal (5 years) and Electrical Experimenter.....	2.20	1.55
Puck and Electrical Experimenter.....	7.00	4.80
Christian Herald and Electrical Experimenter.....	3.00	1.90
Rural New Yorker and Electrical Experimenter.....	2.40	1.75
Outing and Electrical Experimenter.....	4.20	3.25
Yachting and Electrical Experimenter.....	3.00	2.45

MAGAZINE BARGAINS

Cost per year by separate copy. Our rate per year.

Outlook and Electrical Experimenter.....	\$6.20	\$3.50
Boys' Magazine and Electrical Experimenter.....	3.00	1.40
Youth's Companion and Electrical Experimenter.....	3.80	2.75
American Boy and Electrical Experimenter.....	2.40	1.55
The Black Cat and Electrical Experimenter.....	2.40	1.50
Scientific American and Electrical Experimenter.....	6.40	3.30
Etude and Electrical Experimenter.....	3.00	2.05
Literary Digest and Electrical Experimenter.....	6.40	3.95
Delineator and Electrical Experimenter.....	3.00	1.90
Everybody's and Electrical Experimenter.....	3.00	2.00
Adventure and Electrical Experimenter.....	3.00	2.15
Century and Electrical Experimenter.....	5.40	4.30
St. Nicholas and Electrical Experimenter.....	4.20	3.25
Modern Priscilla and Electrical Experimenter.....	2.40	1.60
Boys' World and Electrical Experimenter.....	1.70	1.15
Country Life and Electrical Experimenter.....	5.40	4.30
World's Work and Electrical Experimenter.....	4.20	2.75
The Parisienne and Electrical Experimenter.....	3.00	1.90
Smart Set and Electrical Experimenter.....	4.20	2.90
Field and Stream and Electrical Experimenter.....	3.00	1.90
Travel and Electrical Experimenter.....	4.20	3.55
McBride's and Electrical Experimenter.....	4.20	3.00
Illustrated World and Electrical Experimenter.....	3.00	1.90
Better Farming and Electrical Experimenter.....	1.45	.95
Red Book and Electrical Experimenter.....	3.00	1.90
Blue Book and Electrical Experimenter.....	3.00	2.00
Green Book and Electrical Experimenter.....	3.00	2.00
People's Popular Monthly and Electrical Experimenter.....	1.45	1.00
Farm and Fireside and Electrical Experimenter.....	1.45	1.00
Woman's Home Companion and Electrical Experimenter.....	3.00	2.00
American Magazine and Electrical Experimenter.....	3.00	2.00
Review of Reviews and Electrical Experimenter.....	4.20	3.00
The Farmer's Wife and Electrical Experimenter.....	1.45	1.00
The Farmer and Electrical Experimenter.....	2.40	1.55
Poultry Success and Electrical Experimenter.....	1.70	1.15
Pathfinder and Electrical Experimenter.....	2.40	1.70
Sunset Magazine and Electrical Experimenter.....	3.00	1.80

POINT-TO-DAY

THIS IS THE MOST WONDERFUL MONEY SAVING MAGAZINE BUYING OPPORTUNITY EVER OFFERED OUR READERS TAKE ADVANTAGE OF IT NOW.

TEAR OFF HERE AND MAIL WITH REMITTANCE

EXPERIMENTER PUBLISHING CO., INC. 233 Fulton St., New York City, N. Y.

Please send the following magazines to the addresses given for which I enclose as per your special offer in the December, 1915, Electrical Experimenter. (Write amount you are enclosing.)

(1) (3) (5)

(2) (4) (6)

Name..... Street..... R. F. D..... City..... State.....

WIRELESS TOP FOR AN AUTO-MOBILE.

A report from Belgium tells of the most extraordinary use of an automobile top. It seems that a British patrol succeeded in capturing a German touring car in which two officers were seated. The motor had broken down, and the officers were made prisoners.

In glancing over the car one of the patrol noticed a wire connection to the metallic "skeleton" of the raised top. Following the wire, he pulled from under the seat a

telephone receiver, and holding it to his ear was dumfounded when he could plainly hear a message coming from nowhere in particular.

The top skeleton formed the receiving wires of a wireless station, and the message came from the nearest headquarters of the army corps to which the officers belonged.

The companies constructing the new steel barges that will ply the Mississippi River use electricity to insure absolute safety from fire for their cotton and other inflammable cargoes. Electric energy is now used to operate the motor-driven cranes for loading and discharging cargoes and for cooking and heating in the officers' and crews' cabins.

SEEING A BASEBALL GAME BY WIRE.

(Continued from page 400.)

produced that the spectator really thinks he is at the actual field. Every movement made at the regular ball ground is shown instantaneously at the miniature one here shown. This is accomplished by means of an operator situated on the field, who telegraphs each movement that occurs on the whole field; even if the players are practising or the mascot lifting the bat off the ground, etc. All this is carefully and exactly shown on the screen.

The entire scheme is based on the reversed motion picture theory; instead of the film moving from one reel to another in front of a light, the light moves behind a fixed transparent film. This film or transparent screen, to be more exact, is a solid mass of miniature baseball figures, anyone of which becomes animated with the switching on of an electric light in the rear. Each figure is carefully concealed in a light-tight box, and when a play is about to be enacted, the operator moves his light along a line of the figures, each becoming successively illuminated and instilled with life in due course.

The players run bases, sliding head or feet first, jump into the air for the ball and in exactly the same way as the player does in real life. Also, as the photograph shows, a miniature bleacher crowd is placed in front of the screen, and at either side of same are mounted complete score boards, which give the names of the players, their position on the team, the "runs," "hits" and "errors." "Outs," "bal's" and "strikes" are duly recorded instantly by electric bulbs, placed alongside these terms, and which appear in the illustration.

This wonderful device is the outcome of three years of continuous labor and ingenuity on the part of George S. Coleman. Photograph by courtesy of I. Stein, of Life-Like Baseball Player Co.

Dyke's Book—FREE

interesting, instructive—tells you how to learn AUTO TRADE, how to become a chauffeur and repairman.—SEND FOR IT—To-day—Now!

WITH DYKE'S WORKING MODELS

NEW OF TEACHING IDEA BY MAIL

CHARTS, MAXIMUMS, ETC.

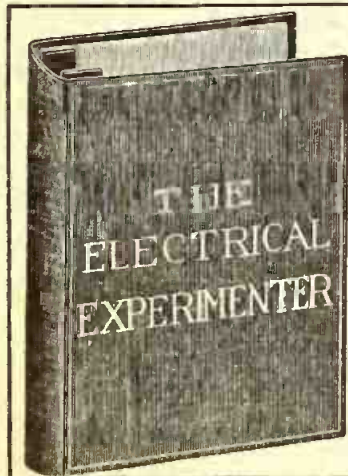

Handy Binder for THE ELECTRICAL EXPERIMENTER

Holds and preserves 12 issues, each of which can be inserted or removed at will, without tools. Will keep your magazines perfectly for all time or just preserve them like new till you bind them permanently. Made of heavy material, extra strongly reinforced at the back and covered with handsome green cloth, suitably lettered in gold. . . . **50c**

Shipping weight 2 lbs. Add sufficient postage, otherwise we will have to send binder by express.

Order a Binder To-day and Preserve Your Magazines.

Experimenter Pub. Co., Inc., 233 Fulton St., N. Y. Book Dep't.

ACCEPT THIS BOOK FREE IT'S INVALUABLE YET CAN'T BE BOUGHT

Just as you will receive it, cloth bound, size 7 x 10 1/4 ins., 160 pages, 20 lessons, 350 illus., 30 tables, with every bit of information on Wireless you can possibly want, besides valuable information on Electricity, Magnetism and Theory of them—and it's FREE as explained.



Will you take a 20 lesson Wireless Course absolutely FREE—even postage charge prepaid?

A course that tells you everything you can possibly want to know about "Wireless" starting off in Lesson No. 1 by explaining the Principles of Electricity. The Second and Third Lessons are devoted to magnetism, motors, generators and wiring. And then, by simple easy stages this wonderful Course takes you into "Wireless." The mysteries of "Wireless" are unfolded to you by the use of such simple language so skillfully used, that of necessity you must understand every word. The subject is not treated superficially, however, for there is a whole lesson devoted to the Theory and Mathematics of this epoch marking subject. To lend charm to the Course, the last Lesson (No. 20) is devoted to a history of Wireless and the men who developed it. The wireless course positively cannot be bought, but will be sent absolutely free with a full year's subscription (12 numbers) of the Electrical Experimenter at \$1.00. It's the biggest dollar's worth you can ever buy anywhere at any time. Send for it to-day enclosing \$1.00. Send now before you forget. The coupon below is a convenient way. But do it now.

THE EXPERIMENTER PUB. CO., Inc. Publisher "The Electrical Experimenter Magazine."

EXPERIMENTER PUB. CO., 233 Fulton St., New York

Gentlemen:

On your absolute guarantee that your 20 Lesson Wireless Course is just as described by you, you may send me same FREE. You are to send me this Course at once, all charges paid, and enter my name for a full year's subscription to the Electrical Experimenter, 12 numbers, for which I enclose \$1.00, the price of the Electrical Experimenter alone.

(If a 2-year subscription is desired, enclose \$1.85.)

My name is.....

My address is.....

(12) *Canada and Foreign Countries, \$1.50—2 years, \$2.85.

WITH THE AD MAN.

The service as rendered by some magazines to their readers is something like "clam digging," which is "neither fishing nor farming," and always hard to define. The new service we are trying to give to readers of the Electrical Experimenter will not be an indefinite something, but always definite, and really valuable.

How many times have you wanted to make some particular article or piece of apparatus, and found when one-half completed you were unable to obtain some part or material which was absolutely essential? Most frequently, when that happened, you had to let matters rest, until by accident or by long search you located the manufacturer or dealer of the article you wanted.

With our wonderfully large research facilities we can almost always place you in immediate touch with the manufacturer or dealer of just the article you want.

This service will be free of charge to you, and we know you will appreciate it.

Address your letter to the Advertising Dept., and I will see that every endeavor is made to supply you with the information you desire. MILTON HYMES.